

COMBIVERT F5



ELEVATOR DRIVE

Version 3.21

00F5LUB-K321
REV 1A - 08/2014



This instruction manual describes the KEB F5 ELEVATOR DRIVE. Before working with the unit the user must become familiar with it. This especially applies to the knowledge and observance of the following safety and warning indications. The icons used in this instruction manual have the following meaning:



Danger
Discharge Time
Caution



Pay Attention
Important
Warning



Information
Help
Tip

1. General	6	3.3.5 BiSS / EnDat 2.2 Encoder Interface X3A	56
1.1 Product Description	6	3.3.6 Hiperface Encoder Interface X3A	59
1.2 Summary of Changes	7	3.3.7 UVW Encoder Interface X3A	62
1.2.1 Functions	7	3.3.8 Incremental TTL Encoder Interface X3A SubD	64
1.2.2 Parameters	7	3.3.9 X3B Output TTL Incremental	66
2. Technical Information	8	4. Operation of the unit	67
2.1 Mounting Instruction	8	4.1 LCD Operator	67
2.1.1 Classification	8	4.1.1 Keypad Buttons	67
2.1.1 Physical Mounting	8	4.2 Serial/CAN Hardware Version	68
2.1.2 Harsh Environments	9	4.2.1 LED Indicators	68
2.1.3 Ambient Conditions	9	4.3 SD Card Hardware Version	69
2.2 Electrical Connections	10	4.4 Backward Compatibility	70
2.2.1 Safety First	10	4.5 Menus and Navigation Overview	70
2.2.2 Voltage Supply	10	4.6 Home Screen	70
2.2.3 Disconnect Switch	10	4.7 Languages	71
2.2.4 Fusing	11	4.8 Programming Menu	72
2.2.5 Line Chokes	13	4.8.1 Parameter Adjustment	73
2.2.6 Motor Thermal Protection	13	4.8.2 Setting the Password	74
2.2.7 Motor Cable Length	14	4.8.3 Units	76
2.2.8 High Voltage Connections	15	4.9 Diagnostics Screen	77
2.2.9 Ground Connections	16	4.9.1 Error Messages & Fault Log	77
2.2.10 High Frequency Shielding	16	4.9.2 Fault Data Logging	78
2.2.11 Storage of Unit	18	4.10 Date & Time	79
2.3 Model Number Information	19	4.10.1 Setting the date	79
2.4 Technical data 230V (size 13 to 21)*	20	4.10.2 Setting the time	79
2.5 Technical data 480V (size 13 to 26)*	22	4.11 Customizing Parameter Lists	80
2.6 Dimensions and weight	24	4.12 Customizing Defaults	82
2.7 Summary of the power circuit terminals	25	5. Initial Start Up	83
2.8 Connection of the power circuit	26	5.1 Connecting the drive and operator	83
2.8.1 Ferrite Ring Installation	28	5.1.1 Default Operator and Drive	83
2.9 Time dependent overload curve	31	5.1.2 Previously programmed Operator or Drive	83
2.10 Low Speed Overload	32	5.1.3 Copying Motor Data to Drive and Operator	83
3. Control Connections	33	5.2 Manual Programming	84
3.1 Control Circuit	33	5.2.1 Getting Started	84
3.1.1 Terminal Strip Connections F5-A	33	5.3 Basic Setup	85
3.1.2 Connection of the control signals	34	5.4 Inputs	85
3.1.3 Digital Input	34	5.5 Motor Data	86
3.1.4 Analog Inputs	34	5.5.1 Induction Motors	86
3.1.5 Voltage Input / External Power Supply	35	5.5.2 Permanent Magnet Motors	86
3.1.6 Digital Outputs	35	5.6 Encoder Data	87
3.1.7 Relay Outputs	35	5.7 Machine Data	87
3.1.8 Analog Outputs	35	5.8 Speed Profile	88
3.1.9 Voltage Output	35	5.8.1 Profile Adjustment	88
3.2 Control Circuit - STO	36	5.9 Motor Learn	90
3.2.1 Assembly of the wires (F5-K)	37	5.10 Encoder Learn	91
3.2.2 Terminal Strip Connections (F5-K)	38	5.10.1 SPI Encoder Learn	92
3.2.3 Digital Inputs (F5-K)	40	5.10.2 Encoder Pole Position Learn	93
3.2.4 Analog Inputs (F5-K)	40	5.10.3 Encoder Synchronization	93
3.2.5 Digital Outputs (F5-K)	40	5.11 Running the Motor	94
3.2.6 Relay Outputs (F5-K)	40	5.11.1 Running at High Speed	94
3.2.7 Analog outputs (F5-K)	41	5.12 Advanced Ride Adjustments	95
3.2.8 STO Connections (F5-K)	41	5.12.1 Inertia Learn	95
3.2.9 STO Inputs (F5-K)	42	5.12.2 Pretorque	96
3.2.10 STO Output (F5-K)	42		
3.3 Encoder Feedback Interfaces	43		
3.3.1 Incremental TTL Encoder Interface X3A Screw Terminals	45		
3.3.2 EnDat Encoder Interface X3A	47		
3.3.3 Sin/Cos Encoder Interface X3A	50		
3.3.4 SSI Encoder Interface X3A	53		

6.Parameter Description 98

6.1 US - Basic Setup Parameters.....	100
6.2 LI - Input Parameters	110
6.3 LM - Motor Data Parameters	129
6.4 LE - Encoder Data Parameters	144
6.5 LN - Machine Data Parameters	153
6.6 LS - Speed Profile Parameters.....	155
6.7 LL - Tune Parameters.....	166
6.8 LC - Control Setting Parameters	168
6.9 LT - Timer Parameters.....	185
6.10 LP - Positioning Parameters	188
6.11 LX - Special Functions Parameters	195
6.12 CH - Configuration Handling Parameters.....	199
6.13 LA - Analog I/O Parameters.....	207
6.14 LO - Outputs Parameters.....	213
6.15 FB - Field Bus Parameters	219
6.16 DG - Diagnostics Parameters (Combivis only)	232
6.17 TS - Terminal Slowdown Parameters	242

7. Diagnostics and Troubleshooting 248

7.1 Diagnostics Screens	248
7.2 Drive Faults	250
7.3 Operation Problems	273
7.4 Diagnostic Solutions	280
7.5 Learn Procedure Troubleshooting	285

8. Parameter Reference 288

8.1 v3.21 Parameter List Reference.....	288
8.2 v1.72 Crossover Reference	303

9. Errata 309

10. Combivis.....311

10.1 Software.....	311
10.1.1 Configuration IDs	311
10.2 Cables	312



Danger to Life

AC motor controls and servo drives contain dangerous voltages which can cause death or serious injury. During operation they can have live "energized" un-insulated parts, moving parts, as well as hot surfaces. Care should be taken to ensure correct and safe operation in order to minimize risk to personnel and equipment.



Only Qualified Personnel

All work involving this product, installation, start up as well as maintenance, may only be performed by qualified electrical technical personnel. According to this manual "qualified" means: those who are able to recognize and acknowledge the possible dangerous conditions based on their training and experience and those who are familiar with the relevant standards and installation codes as well as the field of power transmission.



Protect Against Accidental Contact

AC motor controls and servo drives must be protected against physical damage during transport, installation, and use. Components or covers must not be bent or deformed as this may decrease insulation distances inside the unit resulting in an unsafe condition. On receipt of the unit visual damage should be reported immediately to the supplier. **DO NOT ATTEMPT TO POWER UP A UNIT WITH VISIBLE PHYSICAL DAMAGE.** This unit contains electrostatically sensitive components which can be destroyed by in correct handling. For that reason, disassembly of the unit or contact with the components should be avoided.



Note Capacitor Discharge Time

Before any installation and connection work can be done, the supply voltage must be turned off and locked out. After turning off the supply voltage, dangerous voltages may still be present within the unit as the bus capacitors discharge. Therefore it is necessary to wait 5 minutes before working on the unit after turning off the supply voltage.



Secure Isolation

The low voltage control terminal strip and communication ports are securely isolated in accordance with EN50178. When connecting to other systems, it is necessary to verify the insulation ratings of these systems in order to ensure the EN requirements are still met. When connecting the unit to a grounded delta power system, the control circuit can no longer be classified as a "securely isolated circuit".

Before putting the motor control into operation be sure the connection terminals are tight and all covers removed for installation have been replaced.



Damage to Property and Injury to Persons

The AC motor control or servo system can be adjusted to self initiate an automatic restart in the event of a fault or error condition. The design of the system must take this into account, such that personnel are safe guarded against potentially dangerous circumstances.



Redundant Safety Mechanisms

Software functions in the AC motor control or servo system can be used to control or regulate external systems. However, in the event of failure of the motor control or servo system there is no guarantee these software function(s) will continue to provide the desired level of control. As a result, when operator or machine safety is at stake, external elements must be used to supplement or override the software function within the AC motor control or servo system.

General

1. General

1.1 Product Description

In selecting the COMBIVERT F5 series inverter, you have chosen a frequency inverter with the highest quality and dynamic performance.

The F5 inverter has the following features:

- Small mounting footprint
- Large die IGBTs
- Power circuit gives low switching losses
- Low motor noise with high carrier frequency
- Extensive protection for over- current, voltage and temperature
- Voltage and current monitoring in static and dynamic operation
- Short circuit proof and ground-fault proof
- Noise immunity in accordance with IEC1000
- Hardware current regulation
- Integrated temperature controlled cooling fan
- PM motor control capable
- Synthesized-pre torque for roll back compensation
- CE compliant and cULus listed
- Extensive elevator functional capabilities
- DPC - Direct Position Control
- Stationary Pole Identification (SPI)
- Multi-lingual LCD display
- Structured parameter lists to simplify adjustment and handling
- OEM customization without special software
- Adjustment wizards for start up and operation
- Redundant elevator safety features

This manual describes the frequency inverter COMBIVERT F5.

- 7.5 hp...60 hp 270A peak / 230V class
- 7.5 hp...175 hp 450A peak / 480V class

CPU Software version 4.3 or greater
Application Software Version 3.21

It is exclusively designed for smooth speed regulation of a three-phase motor.

The operation of other electrical loads is forbidden and can lead to destruction of the unit.

1.2 Summary of Changes

1.2.1 Functions

The following functions are new. Each will be described in more detail on the following pages.

- NTSD mode expanded; see LI04 NTSD additional functional description.

1.2.2 Parameters

The following parameters are new to software version 3.21. Each will be described in more detail on the following pages.

- TS Terminal Slowdown Parameter Group, TS01 - 08.
- NTSD Diagnostics, DG63 - 68
- LL18 NTSD Tune Mode
- LO05, 10, 15, 20 = NTSD Output (14)

The following parameters have been removed from the parameter list. Their function is either no longer required or has been moved to another parameter.

- DG63 changed from CAN State Machine to NTSD Speed 1 Up.
- LX19 NTS2 Speed moved to TS Terminal Slowdown parameter group.
- LX20 NTS3 Speed moved to TS Terminal Slowdown parameter group.

Technical Information

2. Technical Information

2.1 Mounting Instruction

2.1.1 Classification



The elevator drive is classified as an “Open Type” inverter with an IP20 rating and is intended for “use in a pollution degree 2 environment.” The unit must be mounted inside of a control cabinet offering proper environmental protection.

2.1.1 Physical Mounting

Install the inverter in a stationary location offering a firm mounting point with low vibration.

Installation of the inverter on a moving system may require special earth ground connections to the inverter.

For best high frequency grounding, install the inverter on a bare metal sub-panel, i.e. zinc plated steel or galvanized steel.

Take into consideration the minimum clearance distances when positioning the inverter (see drawing below). The F5 series inverters are designed for vertical installation and can be aligned next to each other. Maintain a distance of at least 2 inches in front of the unit. Make sure cooling is sufficient.

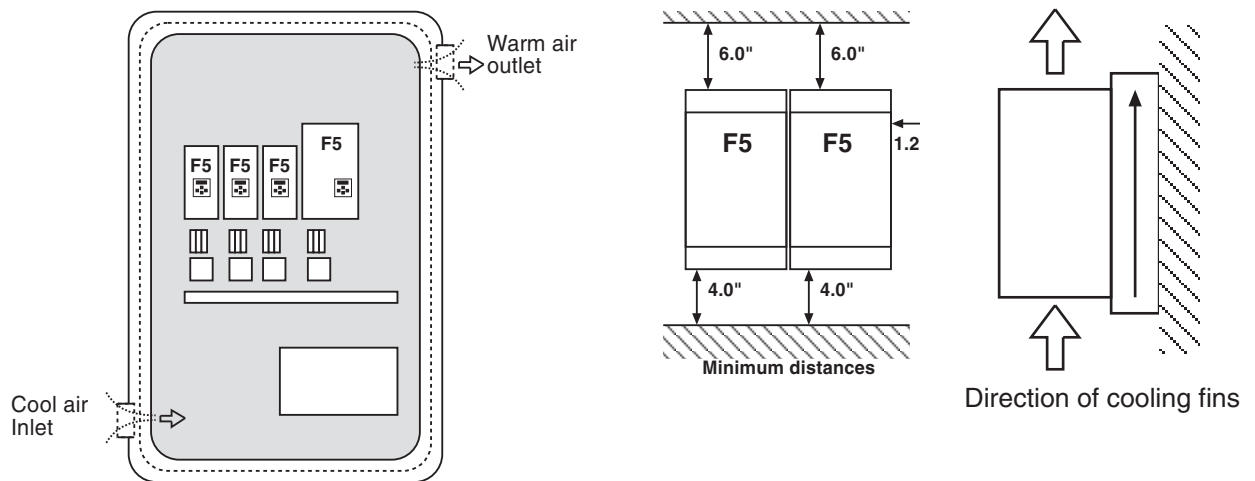

2.1.2 Harsh Environments

For extended life, prevent dust from getting into the inverter.

When installing the unit inside a sealed enclosure, make sure the enclosure is sized correctly for proper heat dissipation or that a cooling system has been installed in the panel.



Protect the inverter against conductive and corrosive gases and liquids. Water or mist should not be allowed into the inverter.

The F5 elevator drive must be installed in an explosion-proof enclosure when operating in an explosion-proof environment.

2.1.3 Ambient Conditions



Maximum Surrounding Air Temperature 45°C! The operating temperature range of the unit is -10°C to + 45°C (14°F to +113°F). Operation outside of this temperature range can lead to shut down of the inverter.

The unit can be stored (power off) in the temperature range -25°C to 70°C (-13°F to +158°F).

The power rating of the inverter must be derated for operation above 3,300 ft (1000 m). Reduce the rated power 1% for each additional 330 ft (100 m). The maximum elevation for operation is 6,560 ft (2000 m).

The relative humidity shall be limited to 95% without condensation.

Technical Information

2.2 Electrical Connections

2.2.1 Safety First



CAUTION - RISK OF ELECTRIC SHOCK! Always disconnect supply voltage before servicing the F5 Elevator Drive.

After disconnecting the supply voltage, always wait 5 minutes before attempting to change the wiring. The internal DC BUS capacitors must discharge.

2.2.2 Voltage Supply

Pay attention to the supply voltage and be sure the supply voltage matches that of the inverter. A 240V unit can be supplied with voltage in the range 180 to 260VAC +/-0%, for a 480V unit the range is 305 to 528VAC +/- 0%, 48Hz to 62 Hz.

All 240V models are suitable for use on a circuit capable of delivering not more than ___ kA rms symmetrical amperes, 240 volts maximum when protected by class ___ fuses rated ___ Amperes as specified in table 2.2.4.1 or when protected by a circuit breaker having an interrupt rating not less than ___ kA rms symmetrical amperes, 240V maximum, rated ___ amperes as specified in table 2.2.4.1.

All 480V models are suitable for use on a circuit capable of delivering not more than ___ kA rms symmetrical amperes, 480 volts maximum when protected by class ___ fuses rated ___ Amperes as specified in table 2.2.4.2 or when protected by a circuit breaker having an interrupt rating not less than ___ kA rms symmetrical amperes, 480V maximum, rated ___ amperes as specified in table 2.2.4.2.



Connection of the F5 series inverters to voltage systems configured as a corner grounded delta, center tap grounded delta, open delta, or ungrounded delta, may defeat the internal noise suppression of the inverter. Increased high frequency disturbance in the controller and on the line may be experienced. A balanced, neutral grounded wye connection is always recommended. The three phase voltage imbalance must be less than 2% phase-to-phase. Greater imbalance can lead to damage of the inverter's power circuit.

2.2.3 Disconnect Switch

A disconnect switch or contactor should be provided as a means of turning off the supply voltage when the unit is not in use or when it must be serviced.

Repetitive cycling on and off of the input supply voltage more than once every two minutes can lead to damage of the inverter.

2.2.4 Fusing



Integral solid state short circuit protection does not provide branch circuit protection. Branch circuit protection must be provided in accordance with the Manufacturer Instructions, National Electrical Code (NFPA70 or CSA22.1) and any additional local codes.

The minimum voltage rating for protection devices used with 240V inverters shall be 250VAC. The minimum voltage rating for protection devices used with 480V inverters shall be 600VAC.

Fuses shall not be installed between the drive and the motor.

In PM motor applications where the drive input current can be lower than the output current, it is allowed to use a protection device with a lower current rating thus being able to optimize line side wiring and ancillary components.



If the controller / elevator drive is supplied through an individual isolation transformer, the maximum fuse amperage rating shall not be greater than 125% of the secondary current rating of the transformer per NFPA70 and CSA 22.1. This value may be significantly lower than the values in the preceding tables.

Branch circuit protection for the F5 must be provided using the fuses as listed in the tables 2.2.4.1 and 2.2.4.2 below. **Fast Acting class J fuses are recommend** due to size and trip speed. Note the amperage value is the maximum value. Lower values may be used based on the relative sizing of the motor to the inverter. If there is an isolation transformer and a harmonic filter installed, a high speed class J fuse must be used (only Ferraz type HSJ is approved).

Table 2.2.4.1 - 230V Units

Unit Size / Housing	SCCR	UL 248	Semiconductor	UL 489
	[kA] rms	Class J Rating [A]	Fuse Number* / Rating [A]	MCCB [A] / Siemens Cat. No.
13 / E	10	40	50 140 06 80 / 80	
14 / G	10	50	50 140 06 100 / 100	
15 / G, H	10, 18	70	50 140 06 80 / 80	
16 / H	18	90	--	
17 / H	18	110	--	
18 / R	100	125	--	150A / DG-frame 3VL 150 UL
19 / R	100	150	--	150A / DG-frame 3VL 150 UL
20 / R	100	175	--	250A / FG-frame 3VL 250 UL
21 / R	100	200	--	250A / FG-frame 3VL 250 UL

* Semiconductor fuses are manufactured by Siba Fuse Inc. When using this type of fuse, this is the model number of the fuse that must be used.

Technical Information

Table 2.2.4.2 - 480V Units

Unit Size / Housing	SCCR	UL 248	Semiconductor	UL 489
	[kA] rms	Class J Rating [A]	Fuse Number* / Rating [A]	MCCB [A] / Siemens Cat. No.
13 / E	10	25	50 140 06 40 / 40	
14 / E	10	30	50 140 06 50 / 50	
14 / G	10	30	50 140 06 80 / 80	
15 / E	10	40	50 140 06 80 / 80	
15 / G, H	10, 18	40	50 140 06 40 / 40	
16 / G, H	10, 18	50	50 140 06 63 / 63	
17 / G, H	10, 18	60	50 140 06 80 / 80	
18 / H	18	70	50 140 06 80 / 80	
19 / H	18	90	50 140 06 100 / 100	
19 / R	100	90	--	150A / DG-frame 3VL 150 UL
20 / H	18	100	--	
20 / R	100	100	--	150A / DG-frame 3VL 150 UL
21 / R	100	150	--	150A / DG-frame 3VL 150 UL
22 / R	100	175	--	150A / DG-frame 3VL 150 UL
23 / R,U	100	200	--	250A / FG-frame 3VL 250 UL
24 / R,U	100	225	--	250A / FG-frame 3VL 250 UL
25 / U	100	275	--	400A / JG-frame 3VL 400 UL
26 / U	100	300	--	400A / JG-frame 3VL 400 UL
27 / U	100	350	--	400A / JG-frame 3VL 400 UL
28 / W	100	400	--	400A / JG-frame 3VL 400 UL

* Semiconductor fuses are manufactured by Siba Fuse Inc. When using this type of fuse, this is the model number of the fuse that must be used.

2.2.5 Line Chokes



A line choke with minimum 3% impedance is required for all 230 V inverters 50hp (size 20) and greater. A line choke with minimum 3% impedance is required for all 480V inverters 100hp (size 23) and greater.

Alternately, an isolation transformer installed between the main line and the elevator drive will satisfy the same requirement.

The line choke (or transformer) is used to prevent nuisance errors and protection caused by voltage spikes. Additionally, the use of a line choke will double the operational lifetime of the DC bus capacitors in the unit. At the same time the choke will reduce the harmonic distortion of the line current from very high values of 80-100% THiD to around 45% THiD.

If lower values of line current distortion are required, Contact KEB regarding an applicable harmonic filter. With such a device it is possible to reduce the harmonic distortion below 8% THiD.

2.2.6 Motor Thermal Protection

The F5 series elevator drive is UL approved as a solid state motor overload protection device. It is necessary to adjust the current trip level in parameter LM09 Electric Motor Protection Current (IM) or LM03 Motor Current (PM). The function assumes the use of a non-ventilated motor. The function meets the requirements set forth in VDE 0660 Part 104, UL508C section 42, NFPA 70 Article 430 part C. See the description for parameter LM08 Electric Motor Protection for the trip characteristics.

A motor winding sensor can also be used for additional safety and the highest level of protection. Either a normally closed contact (rating: 15V / 6mA) or a PTC (positive temperature coefficient) resistor can be connected to the T1, T2 terminals on the inverter. The thermal device should be connected as indicated in Sections 2.7 and 2.8.

The F5 Elevator drive can also accept a KTY type temperature sensor. This sensor will give an analog temperature reading which can be displayed directly in the diagnostic parameters. Additionally, a temperature level can be set to give a warning signal to the controller to indicate the motor is becoming too hot. This allows the controller to stop taking calls or adjust door open time in an effort to reduce motor temp. A KTY sensor is standard on drive sizes with R-housing and above or as an added option to drive sizes in housings H and below.

The KTY device is a solid state device. The approved model number is KTY-84 (1000Ω at 100° C).

Technical Information

2.2.7 Motor Cable Length

In some conventional installations and many MRL applications, the motor can be a considerable distance (greater than 40 feet) from the elevator drive. Under these circumstances the long cable length can cause high voltage peaks or high dV/dt (rate of voltage rise) on the motor windings. Depending on the design of the motor, the long runs can cause damage to the motor winding. Therefore, in these installations the use of a special dV/dt filter is highly recommended.

The standard approved solution is a special output choke. The choke is designed to be used with a maximum of 16kHz switching frequency and low inductance so it does not drastically influence the motor's equivalent circuit model.

There are three sizes available for motors rated up to 100A - All chokes are rated for use up to 550VAC. The part numbers and current ratings are listed below.

<u>Part Number</u>	<u>Rated Current</u>
15Z1F04-1005	22A
17Z1F04-1005	42A
21Z1F04-1005	100A

The use of a conventional line or motor choke on the output of the drive is not recommended since the inductance value is high enough that it would distort the values in the motor model and result in poor control of the motor. In addition, these chokes may not be designed to handle the heating incurred from 16kHz switching operation.

2.2.8 High Voltage Connections

Always note inverter voltage. Select appropriate over current protection devices, select disconnect device, and select proper wire size before beginning the wiring process. Wire the drive according to NFPA 70 Class 1 requirements.

The correct wire gauge for each size inverter can be selected from the charts in Sections 2.4-2.5. The wire gauge is based on the maximum fuse rating for the inverter. The terminal tightening torque can be found for each unit in the same charts.

Always use UL listed and CSA approved wire. Use 60/75°C copper conductors only for equipment rated 100 Amperes or less and use 75°C Copper Conductors only for equipment rated greater than 100 Amperes! Use minimum 300V rated wire with 230V systems and minimum 600V rated wire with 480V systems.

To prevent coupling high frequency noise, the following wires must be spatially separated from each other a minimum distance of 8 inches (20 cm) when they are laid parallel to each other.

- AC supply power and motor lines not connected to inverters
- Motor lines connected to inverters
- Control and data lines (low-voltage level < 48 V)

When using EMI filters, use only the wire provided with the filter to connect the filter to the inverter. Do not add additional wire between the filter and the inverter as this will have a negative effect on the operation of the filter.

Electrical Connection

2.2.9 Ground Connections

When working with high frequencies (> 1kHz) and power semiconductors it is recommended to make all ground connections with large exposed metal surfaces in order to minimize the ground resistance.

The metal sub-plate the inverter is mounted on is regarded as the central ground point for the machine or the equipment. For best results use an unpainted, galvanized or plated sub-panel.

An additional high frequency ground wire should be connected between the inverter and the sub-panel. Use a stranded wire equal in size to the main line conductor or a thick ground strap. This is in addition to the ground wire required by NFPA 70, UL 508, CSA 22.1.

All ground connections should be kept as short as possible and as close as possible to the ground system, sub-panels.

If other components in the system exhibit problems due to high frequency disturbances, connect an additional high frequency ground wire between them and the sub-panel.

The EMI filter should be mounted to the drive or as close as possible to the inverter and on the same sub-panel as the inverter. Good metallic surface contact to the sub-panel is required to provide adequate high frequency grounding of the filter.

2.2.10 High Frequency Shielding

Use of shielded cable is recommended when high frequency emissions or easily disturbed signals are present. Examples are as follows:

- Motor wires: Connect shield to ground at both the drive and motor. NOTE the shield should never be used as the protective ground conductor required by NFPA70 or CSA22.1. Always use a separate conductor for this.
- Digital control wires: Connect shield to ground at both ends.
- Analog control wires: Connect shield to ground only at the inverter.

The connection of meshed shields to the ground connection should **not** be done through a single strand or drain wire of the shield, but with metallic clamps to provide 360° contact around the surface of the shield to the ground point. Connection with a single wire from the braided shield reduces the effectiveness of the shield 70%. Metal conduit clamps work well for this. Be sure the fit is tight.

Ridged metal conduit can be used as the shield of the motor wires. Always observe the following points:

- Remove all paint from the control cabinet and motor housing where the conduit is fastened.
- Securely fasten all conduit fittings.
- Run only the motor wires through the conduit, all other wires, high voltage AC and low voltage signal, should be pulled through a separate conduit.
- Connect the control panel to the Sub-panel with a heavy ground strap.

Should EMI filters be filters used, they should be mounted to the inverter or as close as possible to the inverter and on the same sub-panel as the inverter. Good metallic surface contact to the sub-panel is required to provide adequate high frequency grounding of the filter. Always use the shielding plate provided with the filter when connecting the filter to the inverter.

Shielding of control wires:

- If digital signal wires are terminated on a terminal block in the control panel, the shields should be firmly connected to the sub-panel on both sides of the terminal block.
- The shields of digital signal wires originating outside the control cabinet which are not terminated on a terminal block, must be connected to the sub-panel at the point where the cable enters the control panel and at the inverter.
- If the shield is terminated to the sub-panel within 8 inches (20cm) of the inverter, then the shield no longer needs to be connected to the inverter.
- When using un-shielded signal wires, they should always be installed as a twisted pair (signal and common).
- Low voltage signal wires should cross high voltage wires at right angles

Storage

2.2.11 Storage of Unit

The DC bus of the KEB F5 is equipped with electrolytic capacitors. If the electrolytic capacitors are stored de-energized, the oxide film working as a dielectric fluid reacts with the acidic electrolyte and destroys itself slowly. This affects the dielectric strength and capacity of the unit. If the capacitors start running with rated voltage again, the oxide film tries to build up quickly. This causes heat and gas and leads to the destruction of the capacitors.

In order to avoid failures, the KEB F5 must be started up according to the following specification based on duration of storage period (powered off):

Storage Period: < 1 Year		
Start up normally, without and additional precautions		
Storage Period: 1 - 2 Years		
Power on frequency inverter for one hour without any modulation		
Storage Period: 2 - 3 Years		
Remove all cables from power circuit, including braking resistor connections		
Remove drive enable command		
Connect variable voltage supply to inverter input		
Increase voltage slowly to indicated input level and remain for specified time.		
Voltage Class	Input Voltage	Minimum Time
230V	0 - 160V	15 minutes
	160 - 220V	15 minutes
	220 - 260V	1 hour
460V	0 - 280V	15 minutes
	280 - 400V	15 minutes
	400 - 500V	1 hour
Storage Period: > 3 Years		
Input voltage same as above, however double the amount of time for each additional year. Eventually consider changing capacitors.		

2.3 Model Number Information

Part Number

17.F5.A1G-RLBA

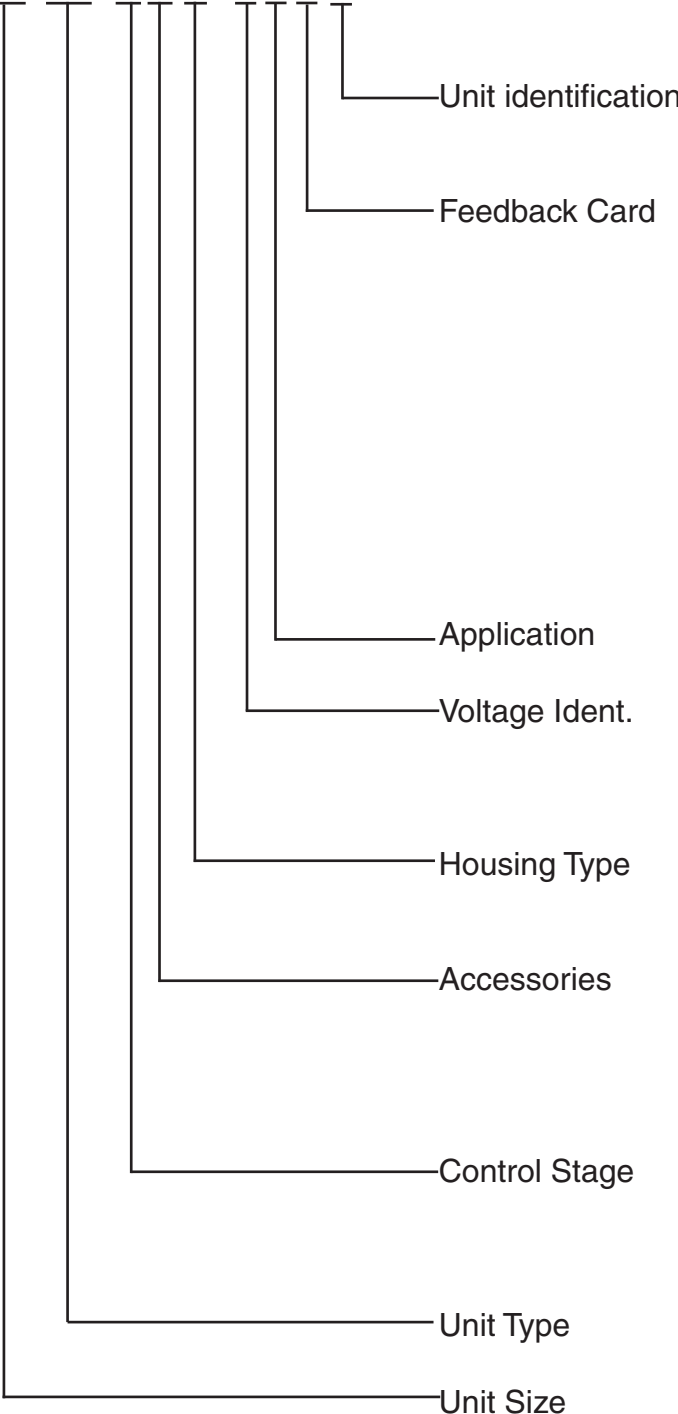

- A = LCD Oper. with SD card
- B = LCD Oper. with Serial/CAN
- C = LCD Oper. with SD card + boosted peak output
- D = LCD Oper. with Serial/CAN + boosted peak output

- 0 = None installed at the factory
- B = Incremental TTL (terminal)....TTL output
- D = Incremental TTL (SubD)TTL output
- F = HiperfaceTTL output
- M = Sin/CosTTL output
- P = EnDatTTL output
- V = SSiTTL output
- 9 = UVWTTL output

*Addition interfaces types and channel configurations available

L = KEB Elevator Drive

- R = 480V, 3-Phase
- P = 230V, 3-Phase

E, G, H, R, U,

- 1 = Braking transistor (standard)
- 3 = Braking transistor and EMI filter

- A = Standard Board - all motor types
- K = Safety Board - all motor types, STO

F5

- 10 = 3 hp 17 = 25 hp 23 = 100 hp
- 12 = 5 hp 18 = 30 hp 24 = 125 hp
- 13 = 7.5 hp 19 = 40 hp 26 = 175 hp
- 14 = 10 hp 20 = 50 hp
- 15 = 15 hp 21 = 60 hp
- 16 = 20 hp 22 = 75 hp

Technical Data

2.4 Technical data 230V (size 13 to 21)*

Inverter Size	13	14	15	16	17
Max Motor Power [hp]	7.5	10	15	20	25
Housing size	E	E	G	G	H
Unit Hardware	A,B	A,B	A,B	C,D	A,B
Input Ratings					
Supply voltage [V]	180...260 ±0 (230 V rated voltage)				
Supply voltage frequency [Hz]	50 / 60 +/- 2				
Input phases	3	3	3	3	3
Rated input current [A]	28	36	55	63	92
Recommended wire gauge ¹⁾ [awg]	10	8	8	6	4
Output Ratings					
Rated output power [kVA]	9.5	13	17	23	29
Rated motor power [kW]	5.5	7.5	11	15	18.5
Rated output current [A]	22	28	42	57	84
Peak current (30 seconds) ²⁾ [A]	36	49.5	72	86	118
Over current fault (E.OC) trip level [A]	43	59	86	104	142
Output voltage [V]	3 x 0...V input (3 x 0...255V ²⁾)				
Output frequency [Hz]	Generally 0 to 1600Hz (limited by control board and carrier frequency)				
Rated switching frequency ³⁾ [kHz]	8	4	8	4	16
Maximum switching frequency [kHz]	16	16	16	16	16
Power loss at rated operation ⁴⁾ [W]	290	350	420	420	550
Stall current at 4kHz [A]	24	33	36	60	73
Stall current at 8kHz [A]	24	24	31	53	73
Stall current at 16kHz [A]	16.8	16.8	26	43	73
Braking Circuit					
Min. braking resistance[Ohm]	16	16	8.0	5.6	5.6
Typ. braking resistance[Ohm]	27	20	13	13	10
Max. braking current [A]	25	25	50	70	70
Installation Information					
Max. shielded motor cable length ⁵⁾ [ft]	330	330	330	330	330
Tightening torque for power terminals [in lb]	11	11	11	35	35
Environmental					
Max. heat sink temperature TOH [°C]	90°C / 194°F				
Storage temperature [°C]	-25...70 °C / -13...158°F				
Operating temperature [°C]	-10...45 °C / 14...113°F				
Housing design / protection	Chassis / IP20 / Pollution Degree 2				
Relative humidity	max. 95% without condensation				
Approvals					
Tested in accordance with...	EN 61800-3 / UL508C				
Standards for emitted interference	EN 55011 Class B / EN 55022 Class A				
Standards for noise immunity	IEC 1000-4-2 / -3 / -4 / -5/ -6				
Climatic category	3K3 in accordance with EN 50178				

*Smaller sizes available



The recommended motor rating is for 4/6 pole standard motors. When using motors with different numbers of poles, the inverter must be dimensioned based on the motor rated current. Contact the manufacturer for special frequency motors.

The power rating of the inverter must be de-rated for operation above 3,300 ft (1000 m). Reduce the rated power 1% for each additional 330 ft (100 m). The maximum elevation for operation is 6,560 ft (2000 m).

Inverter Size	19	20	21
Max Motor Power [hp]	40	50	60
Housing size	R	R	R
Unit Hardware	A,B	A,B	A,B
Input Ratings			
Supply voltage [V]	180...260 ±0 (230 V rated voltage)		
Supply voltage frequency [Hz]	50 / 60 +/- 2		
Input phases	3	3	3
Rated input current [A]	130	143	170
Recommended wire gauge ¹⁾ [awg]	1	2/O	3/O
Output Ratings			
Rated output power [kVA]	42	52	62
Rated motor power [kW]	30	37	45
Rated output current [A]	104	130	154
Peak current (30 seconds) ²⁾ [A]	230	217	270
Over current fault (E.OC) trip level [A]	276	270	315
Output voltage [V]	3 x 0...V input (3 x 0...255V ²⁾)		
Output frequency [Hz]	Generally 0 to 1600Hz (limited by control board and carrier frequency)		
Rated switching frequency [kHz]	8	8	8
Maximum switching frequency ³⁾ [kHz]	16	16	16
Power loss at rated operation ⁴⁾ [W]	1200	1400	1700
Stall current at 4kHz [A]	123	160	198
Stall current at 8kHz [A]	115	145	180
Stall current at 16kHz [A]	70	101	101
Braking Circuit			
Min. braking resistance[Ohm]	3.9	2.0	2.0
Typ. braking resistance[Ohm]	4.7	3.9	3.0
Max. braking current [A]	102	160	160
Installation Information			
Max. shielded motor cable length ⁵⁾ [ft]	165		
Tightening torque for power terminals [in lb]	53		
Environmental			
Max. heat sink temperature TOH [°C]	90°C / 194°F		
Storage temperature [°C]	-25...70 °C / -13...158°F		
Operating temperature [°C]	-10...45 °C / 14...113°F		
Housing design / protection	Chassis / IP20 / Pollution Degree 2		
Relative humidity	max. 95% without condensation		
Approvals			
Tested in accordance with...	EN 61800-3 /UL508C		
Standards for emitted interference	EN 55011 Class B / EN 55022 Class A		
Standards for noise immunity	IEC 1000-4-2 / -3 / -4 / -5/ -6		
Climatic category	3K3 in accordance with EN 50178		

1) The wire gauge is based on the maximum fuse rating, copper wire with a 75°C insulation rating, THHW or equivalent. If circuit protection is selected based on the actual input current, the wire size could be reduced.

2) This is the peak output current limited by hardware regulation. The software current control reserves 5% for closed loop regulation.

3) This is the maximum carrier frequency the power stage can support. The actual operating carrier frequency is adjusted and limited by the control card.

4) This is the power dissipation at the rated carrier frequency, rated voltage and rated load. Operation at reduced carrier frequencies or reduced load will decrease this value.

5) Max motor cable length when using shielded cable, KEB EMI filter, and the installation must conform to EN55011 / EN55022.

Technical Data

2.5 Technical data 480V (size 13 to 26)*

Inverter Size	13	14	15	16	17	18	19
Max Motor Power [hp]	7.5	10	15	20	25	30	40
Housing size	E	E	E	G	G	H	H
Unit Hardware	A,B	A,B	A,B	A,B	A,B	A,B	A,B
Input Ratings							
Supply voltage [V]	305...528 ±0 (480 V Nominal voltage)						
Supply voltage frequency [Hz]	50 / 60 +/- 2						
Input phases	3	3	3	3	3	3	3
Rated input current [A]	15.4	19.6	27.3	35	44	52	57
Recommended wire gauge ¹⁾ [awg]	12	10	10	8	6	6	4
Output Ratings							
Rated output power [kVA]	8.3	11	17	23	29	35	42
Rated motor power [kW]	5.5	7.5	11	15	18.5	22	30
Rated output current [A]	11	14	21	27	34	40	52
Peak current (30 seconds) ²⁾ [A]	21.6	29.7	36	49.5	63	75	90
Over current fault (E.OC) trip level [A]	25.9	35.6	43.2	59.4	75.6	90	108
Output voltage [V]	3 x 0...Vsupply						
Output frequency [Hz]	Generally 0 to 1600Hz (limited by carrier frequency)						
Rated switching frequency ³⁾ [kHz]	8	8	4	8	4	8	8
Maximum switching frequency [kHz]	16	16	16	16	16	16	16
Power loss at rated operation ⁴⁾ [W]	250	320	350	310	360	610	540
Stall current at 4kHz [A]	12	16.5	24	33	42	60	60
Stall current at 8kHz [A]	12	16.5	16	21.5	21.5	50	54
Stall current at 16kHz [A]	12	10	10	9.5	-	30	36
Braking Circuit							
Min. braking resistance [Ohm]	39	39	39	25	25	13	13
Typ. braking resistance [Ohm]	100	85	56	39	28	22	16
Max. braking current [A]	21	21	21	30	30	63	63
Installation Information							
Max. shielded motor cable length ⁵⁾ [ft]	300		330	330	330	330	330
Tightening torque for power terminals [in lb]	4.5	4.5	11	11	11	35	35
Environmental							
Max. heat sink temperature TOH [°C]	90°C / 194°F						
Storage temperature [°C]	-25...70 °C / -13...158°F						
Operating temperature [°C]	-10...45 °C / 14...113°F						
Housing design / protection	Chassis/IP20 / Pollution Degree 2						
Relative humidity	max. 95% without condensation						
Approvals							
Tested in accordance with...	EN 61800-3 /UL508C						
Standards for emitted interference	EN 55011 Class B/EN 55022 Class A						
Standards for noise immunity	IEC 1000-4-2 / -3 / -4 / -5/ -6						
Climatic category	3K3 in accordance with EN 50178						

*Additional sizes available



The recommended motor rating is for 4/6 pole standard motors. When using motors with different numbers of poles, the inverter must be dimensioned based on the motor rated current. Contact the manufacturer for special frequency motors.

The power rating of the inverter must be de-rated for operation above 3,300 ft (1000 m). Reduce the rated power 1% for each additional 330 ft (100 m). The maximum elevation for operation is 6,560 ft (2000 m)

Inverter Size	20	22	24	26		
Max Motor Power [hp]	50	75	125	175		
Housing size	H	R	U	U		
Unit Hardware	A,B	A,B	C,D	A,B	A,B	C,D
Input Ratings						
Supply voltage [V]	305...528 ±0 (480 V Nominal voltage)					
Supply voltage frequency [Hz]	50 / 60 +/- 2					
Input phases	3	3	3	3		
Rated input current [A]	72	105	189	254		
Recommended wire gauge ¹⁾ [awg]	4	1	3/0	350 kcmil		
Output Ratings						
Rated output power [kVA]	52	80	125	173		
Rated motor power [kW]	37	55	90	132		
Rated output current [A]	65	96	172	231		
Peak current (30 seconds) ²⁾ [A]	135	172	230	270	375	450
Over current fault (E.O.C) trip level [A]	162	207	276	324	450	540
Output voltage [V]	3 x 0...Vsupply					
Output frequency [Hz]	Generally 0 to 1600Hz (limited by control board and carrier frequency)					
Rated switching frequency ³⁾ [kHz]	4	8	8	8	4	4
Maximum switching frequency [kHz]	16	16	16	8	8	12
Power loss at rated operation ⁴⁾ [W]	900	1500	1500	2400	2800	2800
Stall current at 4kHz [A]	83	115	173	198	330	330
Stall current at 8kHz [A]	83	115	150	180	180	225
Stall current at 16kHz [A]	45	63	98	–	–	125 ⁶⁾
Braking Circuit						
Min. braking resistance [Ohm]	9	9	4	4.0		
Typ. braking resistance [Ohm]	13	9	6	4.3		
Max. braking current [A]	88	88	200	200		
Installation Information						
Max. shielded motor cable length ⁵⁾ [ft]	165			165		
Tightening torque for power terminals [in lb]	35	53	133	220		
Environmental						
Max. heat sink temperature TOH [°C]	90°C / 194°F	°C	90°C	60°C		
Storage temperature [°C]	-25...70 °C / -13...158°F					
Operating temperature [°C]	-10...45 °C / 14...113°F					
Housing design / protection	Chassis / IP20 / Pollution Degree 2					
Relative humidity	max. 95% without condensation					
Approvals						
Tested in accordance with...	EN 61800-3 / UL508C					
Standards for emitted interference	EN 55011 Class B / EN 55022 Class A					
Standards for noise immunity	IEC 1000-4-2 / -3 / -4 / -5/ -6					
Climatic category	3K3 in accordance with EN 50178					

1) The wire gauge is based on the maximum fuse rating, copper wire with a 75°C insulation rating, THHW or equivalent. If circuit protection is selected based on the actual input current, the wire size could be reduced.

2) This is the peak output current limited by hardware regulation. The software current control reserves 5% for closed loop regulation.

3) This is the maximum carrier frequency the power stage can support. The actual operating carrier frequency is adjusted and limited by the control card.

4) This is the power dissipation at the rated carrier frequency, rated voltage and rated load. Operation at reduced carrier frequencies or reduced load will decrease this value.

5) Max motor cable length when using shielded cable, KEB EMI filter, and the installation must conform to EN55011 / EN55022.

6) 12kHz

Dimensions and Weight

2.6 Dimensions and weight

E Housing

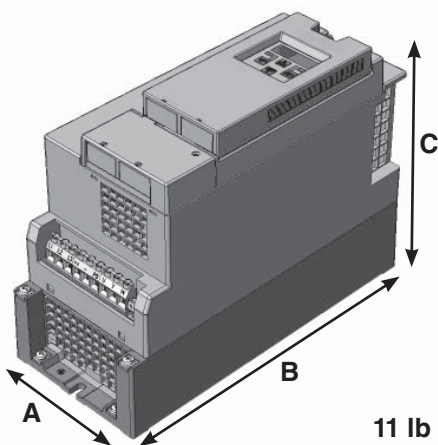

G Housing

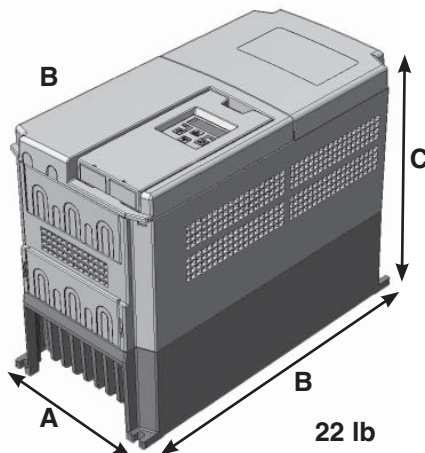

H Housing

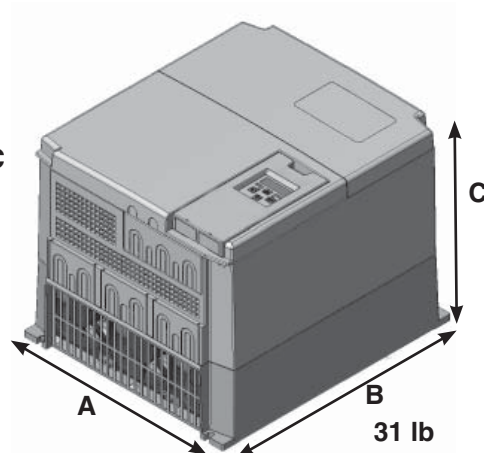

R Housing

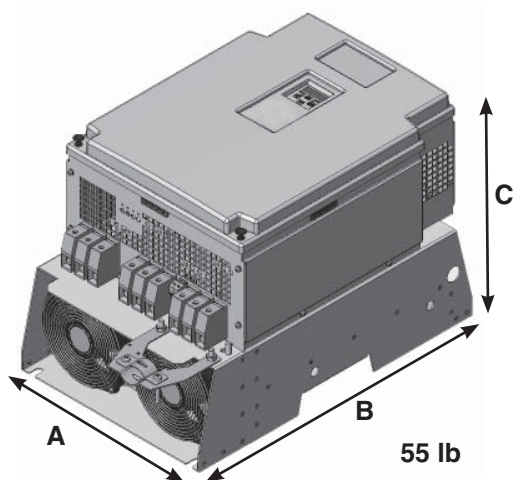

U Housing

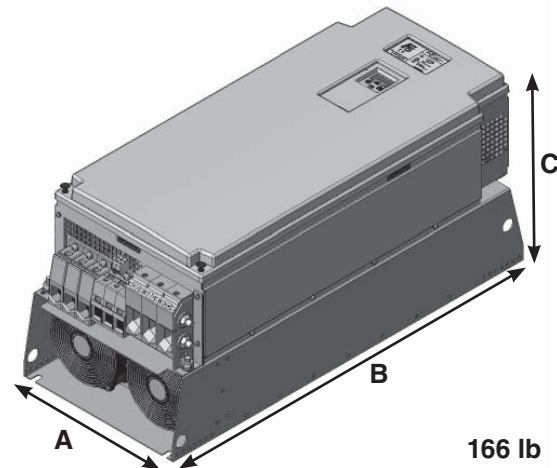

Dimensions in inches

Housing	A	B	C	F	G	H
E	5.12	11.4	8.75	0.28	-	10.8
G	6.7	13.4	10.0	0.28	5.9	13.0
H	11.7	13.4	10.0	0.28	9.8	13.0
R	13.5	20.5	14.0	0.394	11.8	19.5
U	13.5	31.5	14.0	0.394	11.8	30.5

Mounting Holes

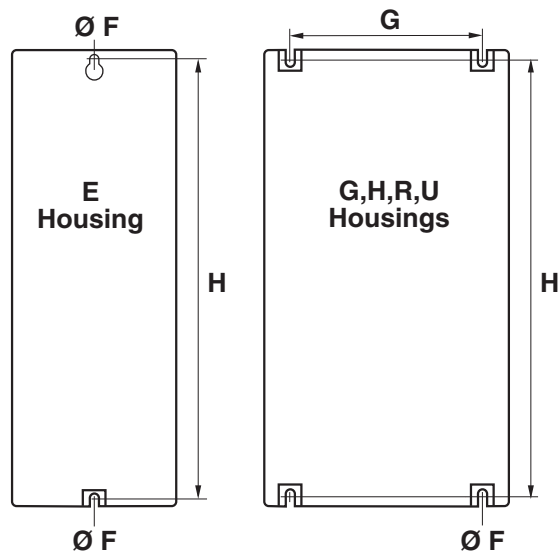

2.7 Summary of the power circuit terminals

Housing size E ⚠️ Verify input voltage with name plate for proper connection 230V or 460V

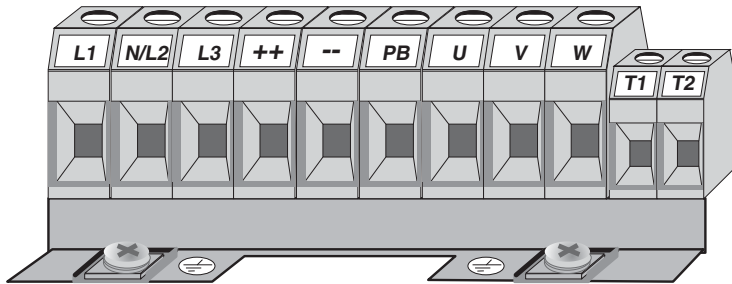

- L1, L2, L3** 3 phase supply voltage
- ++, --** Connection for DC supply
- ++, PB** Connection for braking resistor
- U, V, W** Motor connection
- T1, T2** Connection for temperature sensor
- Connection for earth ground

Terminal Tightening Torque: 4.5 inlbs (0.5Nm)

Housing size G ⚠️ Verify input voltage with name plate for proper connection 230V or 460V

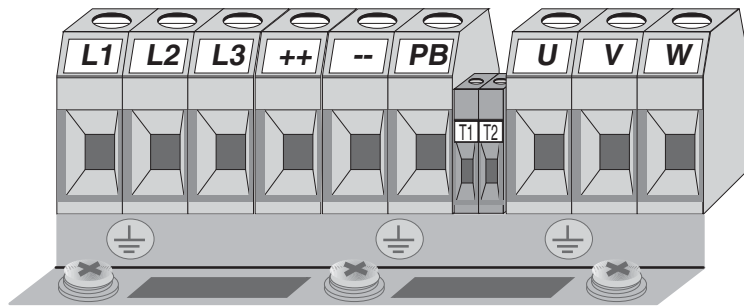

- L1, L2, L3** 3 phase supply voltage
- ++, --** Connection for DC supply
- ++, PB** Connection for braking resistor
- T1, T2** Connection for temperature sensor
- U, V, W** Motor connection
- Connection for earth ground

Terminal Tightening Torque: 11 inlbs (1.2Nm)

Housing size H ⚠️ Verify input voltage with name plate for proper connection 230V or 460V

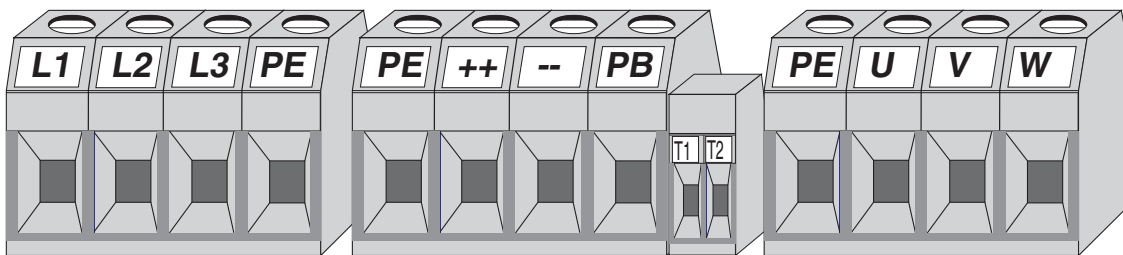

- L1, L2, L3** 3 phase supply voltage
- ++, --** DC supply connection
- ++, PB** Connection for braking resistor
- T1, T2** Connection for temperature sensor
- U, V, W** Motor connection
- PE** Connection for earth ground

Terminal Tightening Torque: 35 inlbs (4Nm)

Power Connections

Housing size R and U  **Verify input voltage with name plate for proper connection 230V or 460V**

Note always verify input voltage with name plate for proper connection

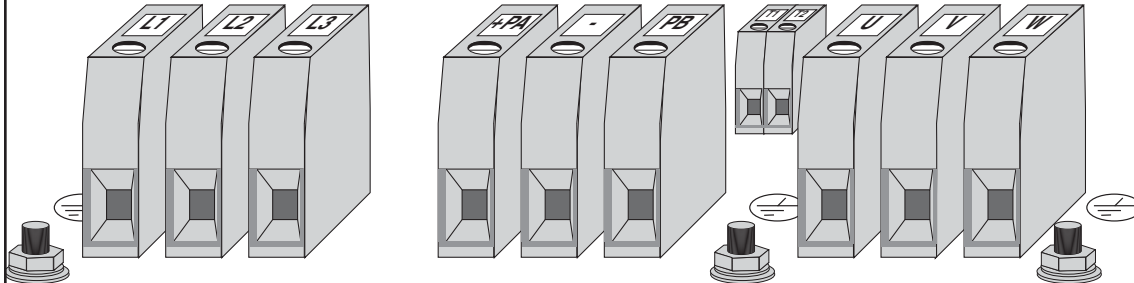

L1, L2, L3
 ++, --
 ++, PB

3 phase supply voltage
 DC supply connection
 Connection for braking resistor

T1, T2
U, V, W

Connection for temperature sensor
 Motor connection
 Connection for earth ground M8 stud.

Note: Ground Stud and Nut shall be connected with UL Listed Ring Connectors (ZMVV), rated suitable.

Terminal Tightening Torque: R housings size <= 22: 53 inlb (6Nm)
 R & U housings size 23/24: 133inlbs (15Nm)
 U housings sizes > 24: 221inlbs (25Nm)
 Ground nut on R & U housings: 89inlbs (10Nm)

2.8 Connection of the power circuit

See technical data in Sections 2.4-2.5 to match the wiring diagram to inverter size and housing type.



If the supply voltage is connected to the motor terminals, the unit will be destroyed!



Pay attention to the supply voltage 230/460V and the correct polarity of the motor!

Wiring diagram 1

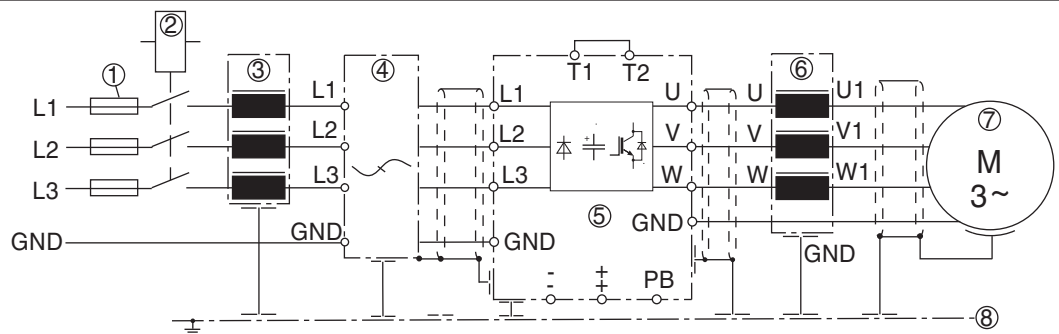

Wiring diagram 2

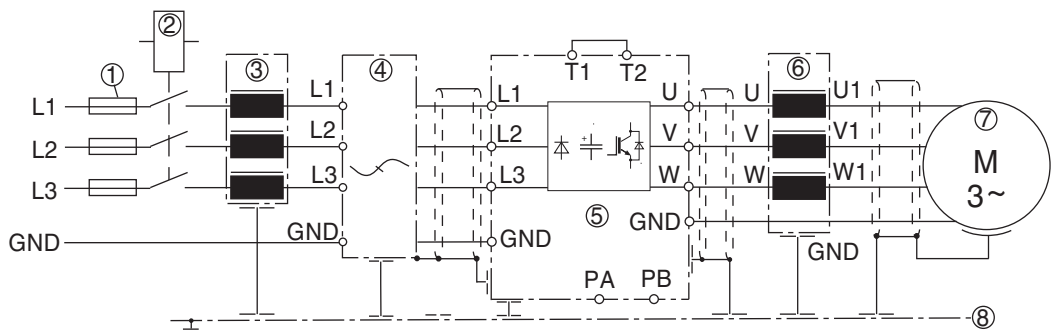

Wiring diagram 3

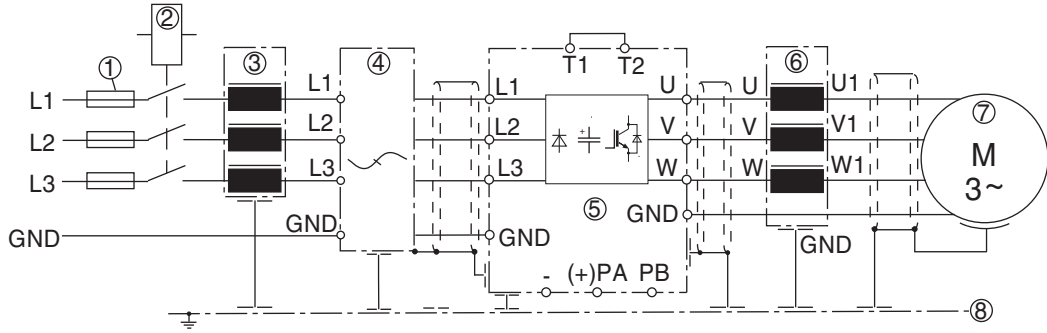

- | | |
|------------------------------------------|---------------------------------------|
| ① Supply fuse | ⑤ COMBIVERT F5 |
| ② Disconnect switch or contactor | ⑥ Motor choke or output filter |
| ③ Line choke | ⑦ Motor |
| ④ Interference suppression filter | ⑧ Sub panel in control cabinet |

External motor temperature sensor (for all units)

Don't install sensor wires with control wires!

Must use double shield when running these wires with motor wires!

It is necessary to activate this function via software parameter! See LX10

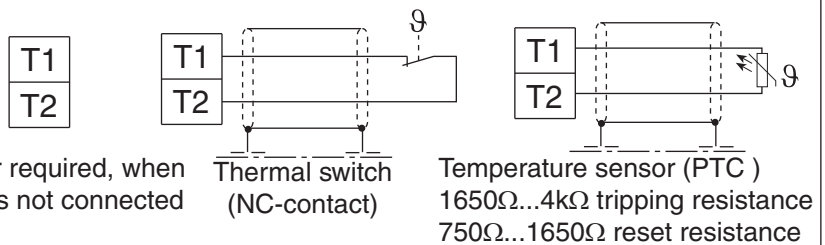

Connection of braking resistor (Braking circuit installed as standard in housing sizes E,G,H, R and U.)

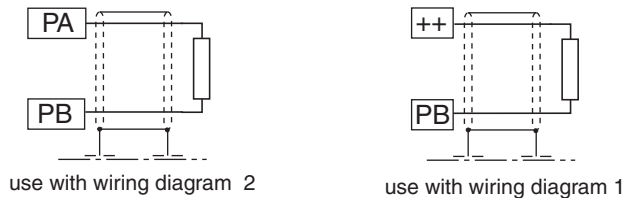

Braking resistor with lineside overtemperature cutoff



This is the only way to turn off voltage to the resistor in the event of failure of the internal braking transistor of the inverter.

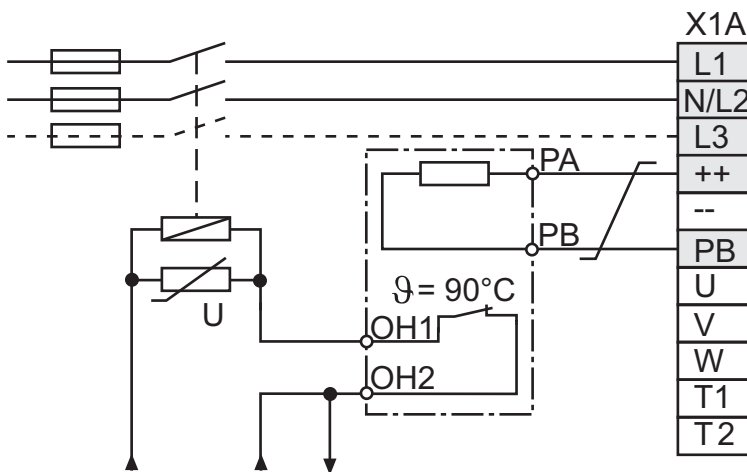

24VDC or 120VAC contactor control voltage
Note: a NC thermal switch not PTC device on the resistor is required.

Power Connections

2.8.1 Ferrite Ring Installation

All PWM type frequency inverters generate high frequencies as a result of fast switching of the IGBT output transistors. As these high frequencies travel along the motor wires they can easily be coupled to other wires in proximity to the motor leads. This is especially true for low voltage encoders. The included ferrite rings can be used to limit the high frequency noise which is transmitted on the motor wires by inserting a small amount of inductance on each motor lead. These rings can also be useful when shielded cables are used, since they will limit the available high frequencies even before the shield on the cable.

The number of ferrites is determined by the housing size of the inverter. Refer to the following table for quantity and part numbers.

Housing Size	Quantity Per Phase (Part Number)	Quantity All Phases (Part Number)
'E'	-	1 (00.90.390-5241)
'G'	-	1 (00.90.390-5241)
'H'	-	1 (00.90.390-5241)
'R'	2 (00.90.396-2010)	2 (00.90.396-3620)
'U'	4 (00.90.396-2010)	4 (00.90.396-3620)

Part Number	Overall Dimensions in mm (inches)
00.90.390-5241	56 x 32 x 18 (2.2 x 1.3 x 0.7)
00.90.396-2010	36 x 23 x 15 (1.4 x 0.9 x 0.6)
00.90.396-3620	58 x 40 x 18 (2.3 x 1.6 x 0.7)

Installation

Ferrites are to be installed over all three motor phase wires and depending on drive size on each of the individual phase wires as well.

The ferrite rings are to be installed on the motor wires as close to the inverter as possible.

Take the first ferrite(s) and pass all three motor phases through the center. Use a wire tie to secure the ferrite(s) to the wire. Note: **Do not pass the earth ground wire through the ferrite(s)**. If ferrites on each of the output phases is specified, continue by passing each phase wire through the center of the ferrite(s) until there are ferrites on each phase. Connect the motor wires to the U,V, W terminals on the inverter using the specified terminal tightening torque. When using shielded motor cable, the ferrites are to be installed on an unshielded section of the cable before the shielding begins. Terminate the shield of the cable either to the inverter or directly to the bare metal sub panel in the control cabinet.

Power Connections

Use with regen units

Ferrite rings are required to limit common mode noise and minimize electrical disturbances on the DC bus connections between the inverter and regen unit(s). Ferrite rings are to be installed over both the ++ and -- DC bus connectors and should be installed as close to the inverter as possible. **Do not pass ground conductors through the ferrite rings.** When multiple regen units in parallel are used with a single inverter, the number of ferrite rings on the DC bus to be installed should be the same as the number of regen units.

Each KEB R6 regen unit is provided with a ferrite ring with the following part number and dimension:

Part Number	Overall Dimensions in mm (inches)
00.90.390-5241	56 x 32 x 18 (2.2 x 1.3 x 0.7)

2.9 Time dependent overload curve

If the load current exceeds the rated current but is below the overcurrent level, an overload timer begins counting. The rate at which the timer increments is a function of load current. The higher the current the faster the increments. When the counter reaches the limit the Error Overload (E.OL) fault is triggered and the output to the motor is shut off. At this point, the inverter begins a cool down period where the inverter is allowed to cool before the fault can be reset. When the drive displays a No Error Overload (E.nOL) message, the inverter has reached an acceptable temperature level and can be restarted.

① Less than size 24

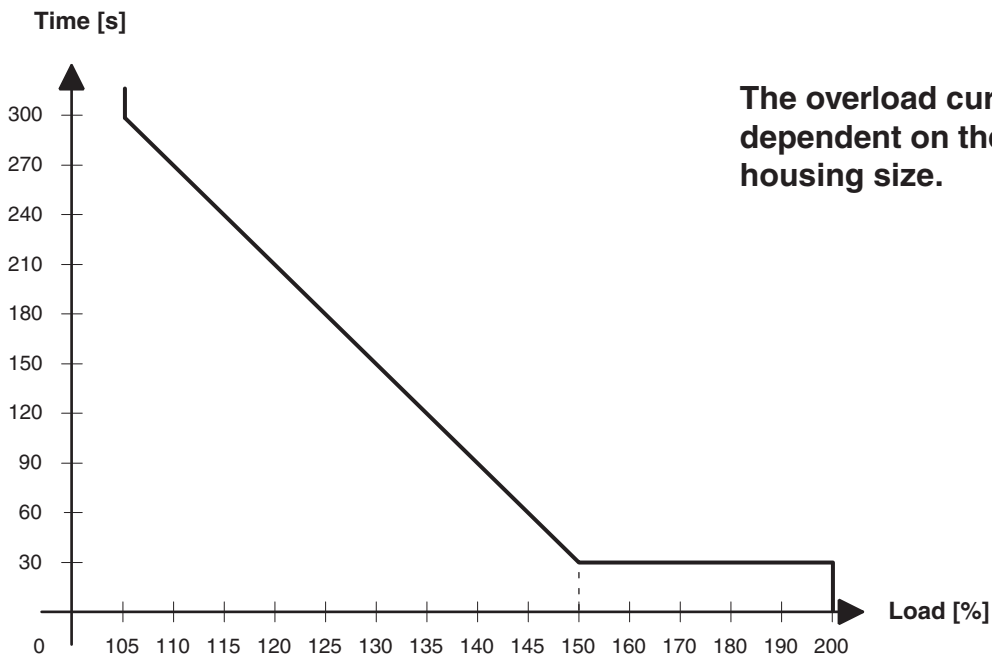

② Size 24 and greater

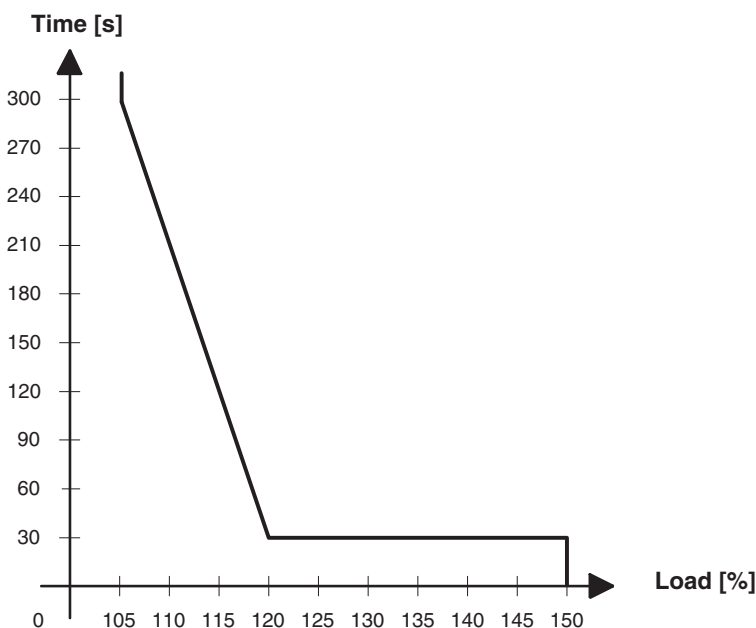

Overload Curves

2.10 Low Speed Overload

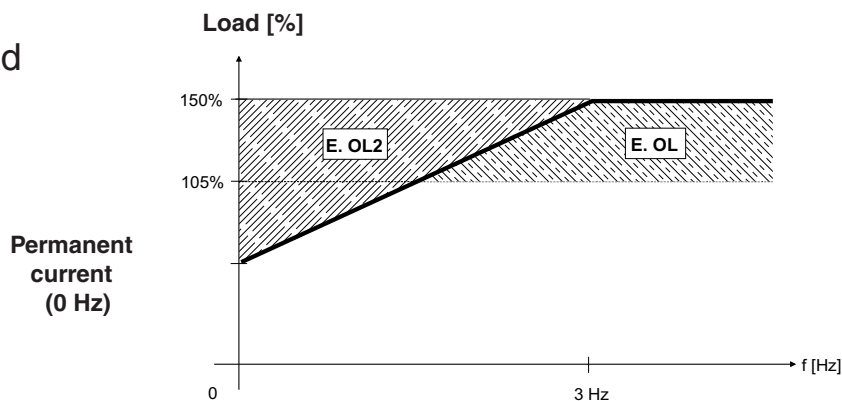

At low speeds (below 3 Hz G-U housings, below 6Hz D-E housings) the rms current flowing through the power transistors is higher, reaching 1.4 times the rated 60Hz rms value. This is caused by the low frequency sine wave created by the PWM. As a result, the continuous output current must be limited at low speeds to prevent the power transistors from overheating. The COMBIVERT F5 will drop the carrier frequency to 4kHz if necessary to be able to continue to provide current to the motor. Once the output frequency rises above low frequency or the current drops below the levels listed below, the carrier frequency will be returned to the higher value.

230V Maximum stall current (amps at 0Hz)

Inverter Housing	Carrier Frequency	Inverter Size										
		13	14	15	15+	16	17	17+	19	20	21	23
E	8 kHz	24	24									
	16 kHz	16.8	16.8									
G	8 kHz		33	31	53							
	16 kHz		33	26	43							
H	8 kHz					73	109	97				
	16 kHz					73	92	59				
R	8 kHz								115	145	180	
	16 kHz								70	102	102	
U	4 kHz											319
	8 kHz											203
	16 kHz											-

460V Maximum stall current (amps at 0Hz)

Inverter Housing	Carrier Frequency	Inverter Size												
		13	14	15	16	17	18	19	20	22	22+	24	26	26+
E	8 kHz	12	16.5	16										
	16 kHz	12	10	10										
G	8 kHz			19	22.0	21.5								
	16 kHz			8.4	9.5	-								
H	8 kHz					42	50	54	83					
	16 kHz					25	30	36	45					
R	8 kHz									115	150			
	16 kHz									63	98			
U	4 kHz											198	330	330
	8 kHz											180	180	225
	16 kHz											-	-	-

3. Control Connections

X2A

3.1 Control Circuit

3.1.1 Terminal Strip Connections F5-A



Terminal tightening torque = 0.5 Nm

PIN	Function	Name	Description	
1	Analog Input 1 +	AN1+	Pattern speed input	Resolution: 12 bit
2	Analog Input 1 -	AN1-		
3	Analog Input 2 +	AN2+	Pre-torque input	Scan time: 1 ms
4	Analog Input 2 -	AN2-		
5	Analog Output 1	ANOUT1	Analog output of the motor speed closed loop, calculated open loop	Voltage range: 0...±10V
6	Analog Output 2	ANOUT2	Analog output of the motor torque 0...10VDC (0...2xT _{Rated (motor)})	
7	+10V Output	CRF	Analog supply voltage for speed ref.	+10VDC +5%, max. 4mA
8	Analog Common	COM	Common for analog in- and outputs	
9	Analog Common	COM		
10	Prog. Input LI04	I1	When I1...I6, I8 are assigned as speed selection, I1>I2>...I8	Ri = 2.1 kOhm, scan time: 1msec,
11	Prog. Input LI05	I2		
12	Prog. Input LI06	I3	Inputs not used for speed selection can be assigned special functions.	LI02 digital filter reduces false trigger due to relay chatter, filter time: 5-50msec (adjustable)
13	Prog. Input LI07	I4		
14	Prog. Input LI08	I5	When I1...I8 are assigned as direction inputs, both directions cannot be signaled together	
15	Prog. Input LI09	I6		
16	Drive Enable	I7	Enable/Disable; response time < 1 msec; Enable instantly turns off motor current	
17	Prog. Input LI11	I8	Same as I1...I6	
18	Digital Out 1	O1	Programmable output LO05 - Default = At Speed	
19	Digital Out 2	O2	Programmable output LO10 - Default = Deceleration Active	
20	24V-Output	V _{out}	Approx. 24V output (max. 100 mA load)	
21	20...30V-Input	V _{in}	Voltage input when an external 24VDC supply is used	
22	Digital Common	0V	Common for digital in-/outputs	
23	Digital Common	0V	Common for digital in-/outputs	
24	Relay 1	NO	Programmable output LO15 - Default "Off"	max. 30VDC, 1A
25		NC		
26		COM		
27	Relay 2	NO	Programmable output LO20 - Default - "Brake Control"	
28		NC		
29		COM		

Control Connections

3.1.2 Connection of the control signals

In order to prevent a malfunction caused by interference voltages on the control inputs, the following steps should be observed:



- Establish a true earth ground for all ground connections!
- Do not connect drive signal commons to earth ground!
- Use shielded cable with twisted pair wires!
- Terminate shield wires to earth ground, only at inverter!
- Separate control and power wires by 8" or more!
- Control and power wires should cross at a right angle!

3.1.3 Digital Input

Use of **internal** voltage supply

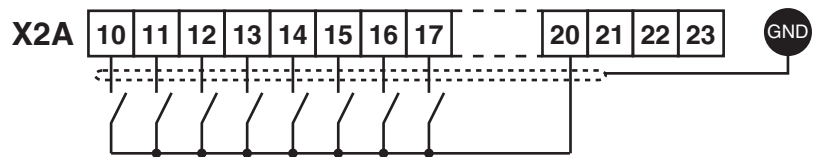

Use of **external** voltage supply

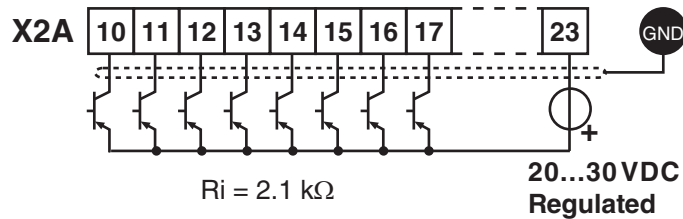

3.1.4 Analog Inputs

Speed Pattern, Torque Command

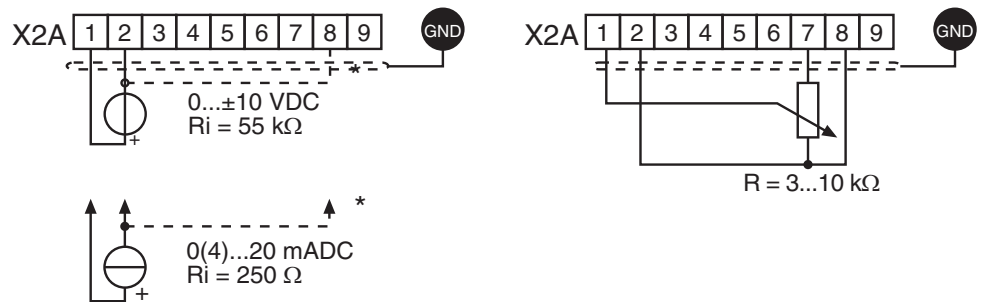

Connect unused analog inputs to common to eliminate noise signals!

3.1.5 Voltage Input / External Power Supply

The supply to the control circuit through an external voltage source keeps the control in operational condition even if the power stage is switched off. To prevent undefined conditions (false triggering), first switch on the power supply then the inverter.

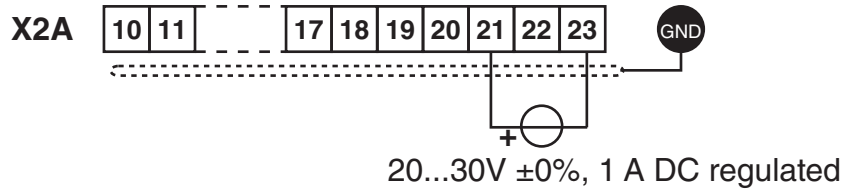

3.1.6 Digital Outputs

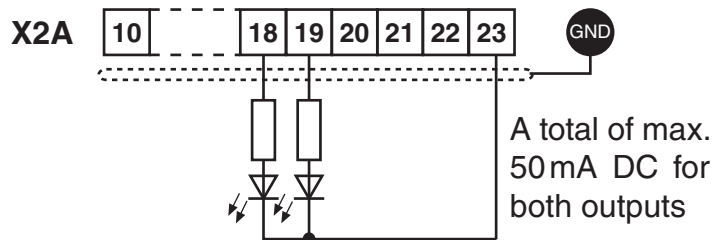

3.1.7 Relay Outputs

In case of inductive loads on the relay outputs, protective wiring must be provided (e.g. RC or diode arc suppression)!

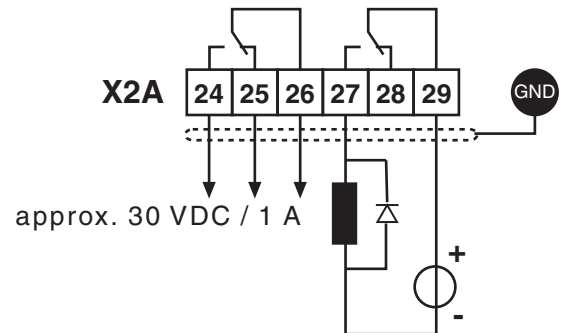

3.1.8 Analog Outputs

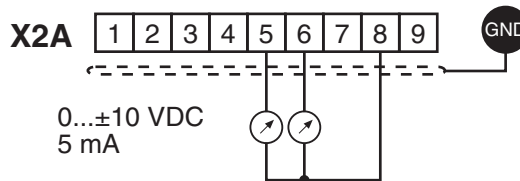

3.1.9 Voltage Output

The voltage output serves for triggering the digital inputs as well as for supplying external control devices. Do not exceed the maximum output current of 100 mA. This output is short circuit protected.

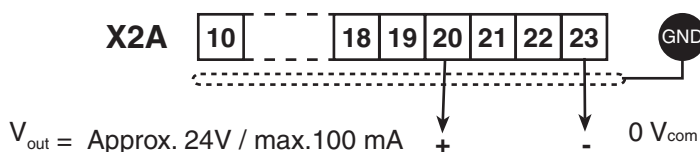

Control Connections (Safety)

3.2 Control Circuit - STO

An optional Safe Torque Off (STO) control card can be used with the F5 drive. The safety control card provides Safe Torque Off functionality in accordance to IEC 61800-5-2.

These inverter units with a safety control card can be identified by the KEB part number and will have a “K” in the 5th placeholder (e.g. xx.F5.**K**xx-xxxx)

The KEB STO card meets performance levels e (ISO13849-1) and SIL 3 (IEC 61508 and IEC62061).

For more information on the control card, see KEB document (00F5NES-K000).

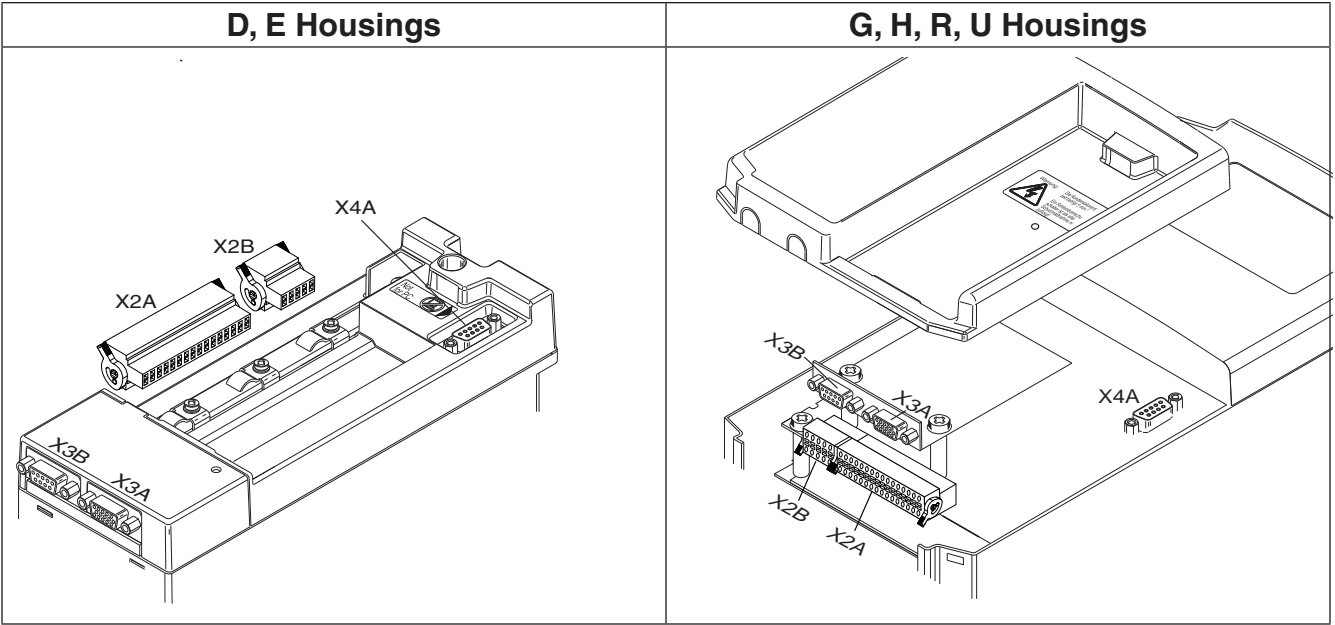

Terminal	Description
X2A	Control terminal strip
X2B	STO terminal block
X3A	Encoder Interface channel 1
X3B	Encoder Interface channel 2
X4A	HSP5 interface

3.2.1 Assembly of the wires (F5-K)

The STO control card uses a spring-loaded terminal strip. Use the following instructions when wiring the control terminals

	Required Tools: Screw Driver SD 0.4 x 2.5 (DIN 5264)	
1	Strip the line about 7mm	
2	Plug screw driver into the middle square slot	
3	Plug stranded wire into the round slot; be sure no wire is seen from the outside	
4	Remove screw driver and check if the wire is fixed. Make sure that the stranded wire and not the insulation is clamped	

Control Connections (Safety)

3.2.2 Terminal Strip Connections (F5-K)

X2A - Control

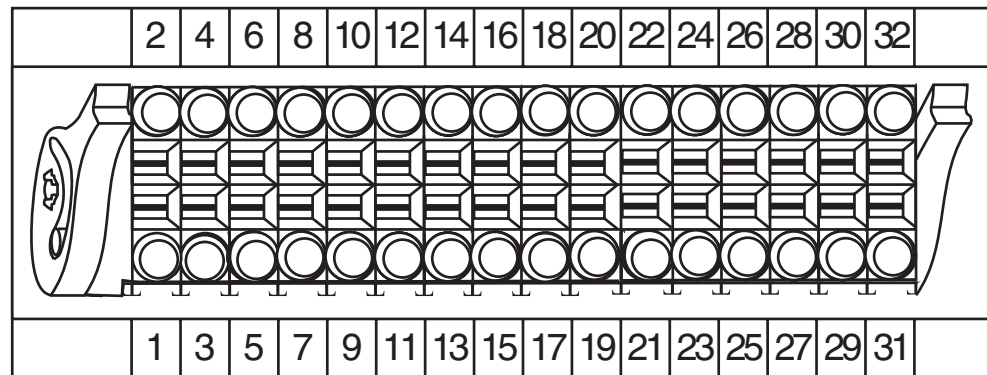

Pin	Function	Name	Description
1	Digital Common	0V	Reference potential for digital inputs/outputs
2	20 ...24V Input	V_{in}	Voltage input when an external 24VDC supply is used $V = 24VDC +20\%/-15\%$ $I_{MAX} = 1A$
3	Digital Common	0V	Reference potential for digital inputs/outputs
4	24V-Output	V_{out}	Approx. 24V output (max. 100 mA load) $V = 24VDC \pm 25\%$ $I_{MAX} (Pin 4 +32) = 100 mA$
5	Prog. Input LI11	I8	See Pins 8-12
6	Drive Enable	I7	Enable/Disable; response time < 1ms; Enable instantly turns off motor current
7	Prog. Input LI09	I6	When I1...I6, I8 are assigned as speed selection, I1>I2>...I8
8	Prog. Input LI08	I5	When I1...I8 are assigned as direction inputs, both cannot be signaled together
9	Prog. Input LI05	I2	
10	Prog. Input LI04	I1	
11	Prog. Input LI07	I4	
12	Prog. Input LI06	I3	Inputs not used for speed selection can be assigned special functions.
13	Digital Out 2	O2	Programmable Output Lo10 Default = Deceleration Active
14	Digital Out 1	O1	Programmable Output Lo05 Default = At Speed
15	Digital Common	0V	Reference potential for digital inputs/outputs
16	+10V Output	CRF	Analog Supply Voltage for speed ref. $+10VDC, +5\%, \text{max. } 4 mA$
17	Analog Input 1-	AN1-	Pattern Speed Input $0... \pm 10VDC (R_i = 55k\Omega)$
18	Analog Input 1+	AN1+	
19	Analog Input 2-	AN2-	Pre-torque Input Resolution: 11Bit + sign Scan time: 1 ms
20	Analog Input 2+	AN2+	
21	Analog Common	COM	Common for analog in- and outputs
22	Analog Output 1	ANOUT1	Analog output of the motor speed closed loop, (open loop = calculated) $V = 0... \pm 10VDC (\text{max. } 11.5VDC)$ $I_{MAX} = 10mA; R_i = 100\Omega$
23	Analog Common	COM	Common for analog in- and outputs Resolution: 11Bit + sign
24	Analog Output 2	ANOUT2	Analog output of the motor torque $0 ... 10VDC (0 ... 2xT_{Rated(motor)})$

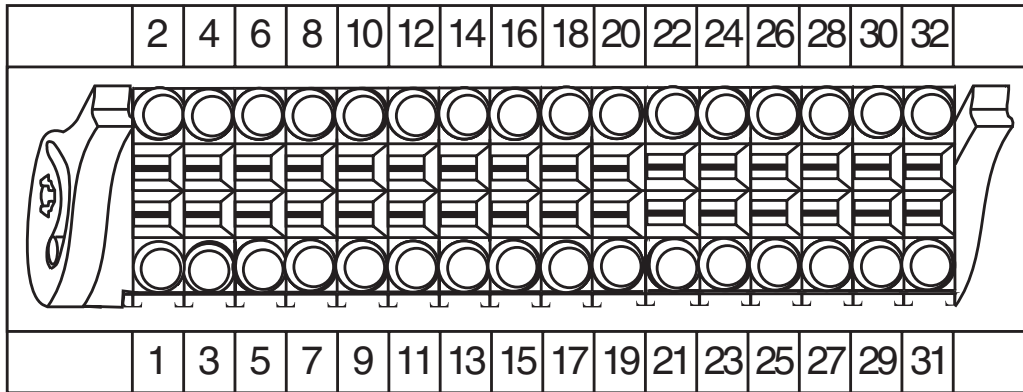

Pin	Function	Name	Description	
25	Relay 2 Common	COM	See pin 29	$V_{MAX} = 30VDC$ $I = 0.01...1A$
26	Relay 1 Common	COM	See pin 30	
27	Relay 2 NC Contact	NC	See pin 29	
28	Relay 1 NC Contact	NC	See pin 30	
29	Relay 2 NO Contact	NO	Programmable Output LO20 Default = Brake Control	
30	Relay 1 NO Contact	NO	Programmable Output LO15 Default = Off	
31	Digital Common	0V	Reference potential for digital inputs/outputs	
32	24V Output	V_{out}	Approx. 24VDC output (max. 100mA load)	

Control Connections (Safety)

3.2.3 Digital Inputs (F5-K)

Use of **internal** voltage supply

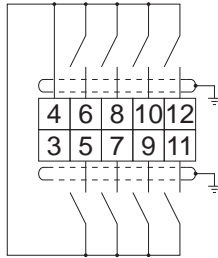

Use of **external** voltage supply

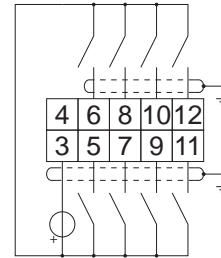

3.2.4 Analog Inputs (F5-K)

Current

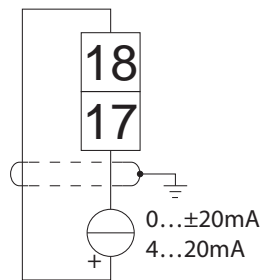

Voltage

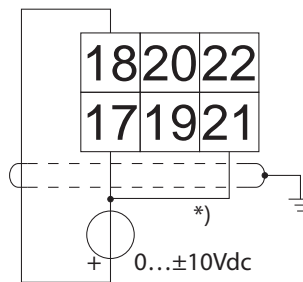

Potentiometer

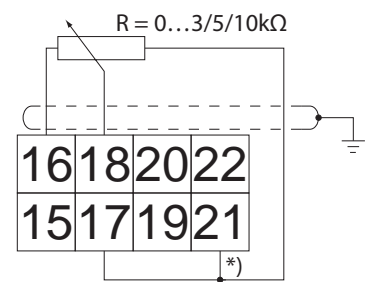

3.2.5 Digital Outputs (F5-K)

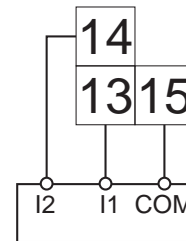
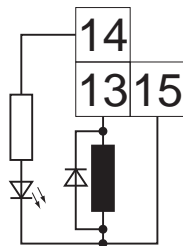

3.2.6 Relay Outputs (F5-K)

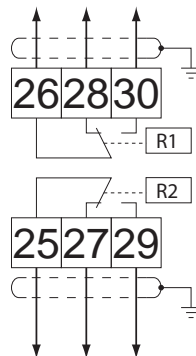

In case of inductive loads on the relay outputs, protective wiring must be provided (e.g. RC or diode arc suppression)

Specifications:

Voltage = max. 30VDC

I = 0.01 ... 1A

3.2.7 Analog outputs (F5-K)

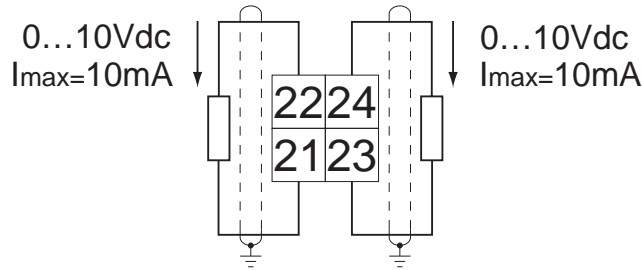

3.2.8 STO Connections (F5-K)

X2B - Safety Control

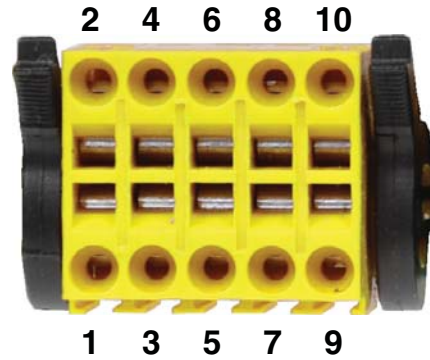

Pin	Name	Description
1	STO1+	Input STO Channel 1
2	STO1+	
3	STO1-	
4	STO1-	
5	STO2+	Input STO Channel 2
6	STO2+	
7	STO2-	
8	STO2-	
9	STO-OUT	Output STO
10	STO-OUT	

The individual channels are designed potential-free, so 24V and 0V can be connected. The inputs are designed by way that safety switchgear units with test pulses (OSSD signals) can be connected. The signals are not evaluated, they are only filtered. The OSSD test interval is limited to 10 ms.

Control Connections (Safety)

3.2.9 STO Inputs (F5-K)

3.2.10 STO Output (F5-K)

The short-circuit proof, digital output is specified in accordance with IEC 61131-2. The output current is 100 mA at 24VDC.

The output is 24VDC if modulation is possible. Inputs STO1, STO2 and ST must be set for it.

3.3 Encoder Feedback Interfaces

The encoder feedback interface is a modular board installed on the control card of the drive depending on encoder type. If the encoder interface is pre-installed by the factory, it will be denoted in the 10th digit of the drive material number (eg. 20F5A1H-RLBA). The encoder feedback interface board will have two ports, X3A and X3B. Various options are available for each port with each combination having a unique indicator in the part number digit.

The primary channel X3A will be the input connection from the motor encoder. The following encoder interface types are available:

- Incremental, TTL (screw terminal strip or subD)
- Incremental, HTL (screw terminal strip or subD)
- EnDat
- Sin/Cos
- SSi
- Hiperface
- UVW
- Resolver
- BiSS / EnDat 2.2

The secondary channel X3B can be either an emulated output of the encoder input or a secondary input (eg. hoistway position, governor encoder, etc.). The following input and output types are available:

- Incremental, TTL output (screw terminal strip or subD)
- Incremental, TTL input (screw terminal strip or subD)
- SSi input



ONLY when the inverter is switched off and the voltage supply is disconnected may the feedback connectors be removed or connected!



For information on interfaces without details listed in this manual, contact KEB.

Encoder Connections

Depending on the type of encoder interface used, below are the general specifications of the incremental channel signals

TTL incremental input/output signal channels

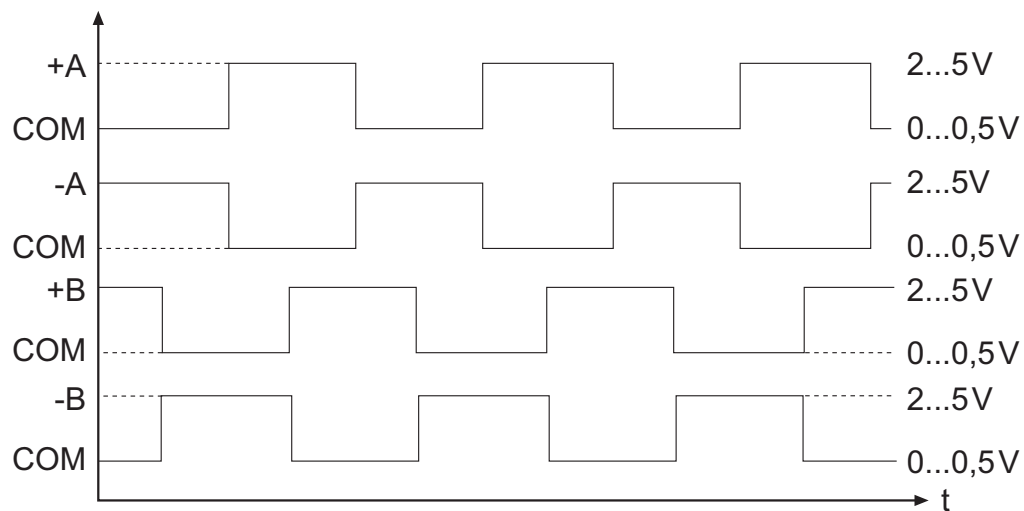

Signal format of EnDat, Sin/Cos, SSi, Hiperface encoder input channels A and B (SIN and COS)

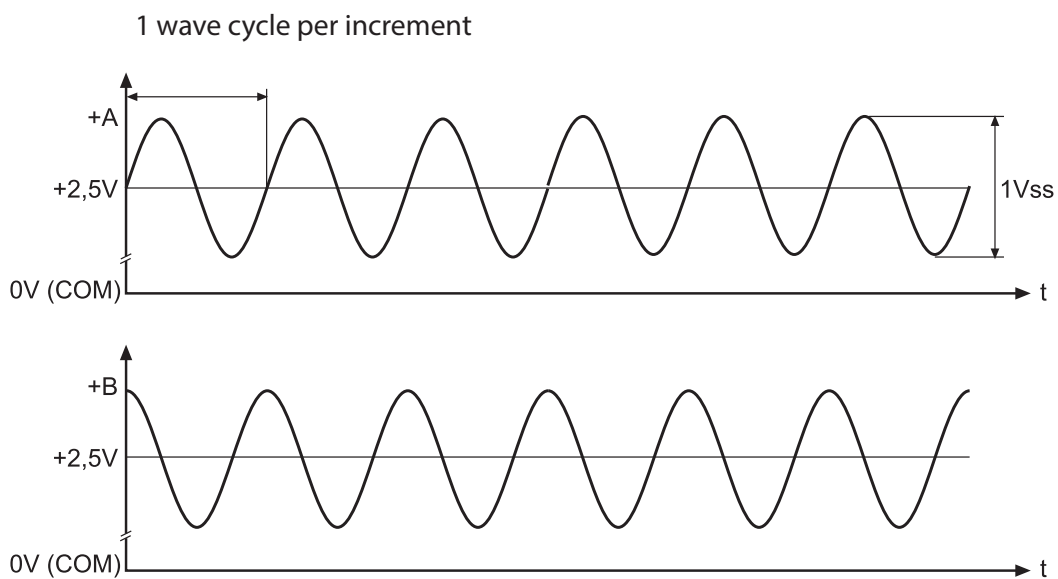

3.3.1 Incremental TTL Encoder Interface X3A Screw Terminals

Connect the incremental encoder mounted on the motor to the 8 position terminal connector at X3A. This connection provides speed feedback and is imperative to the proper operation of the F5.

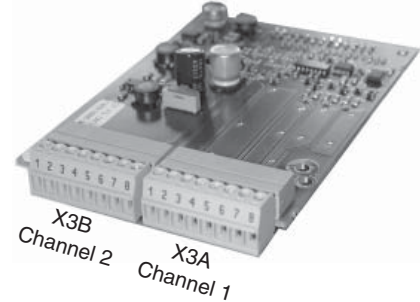
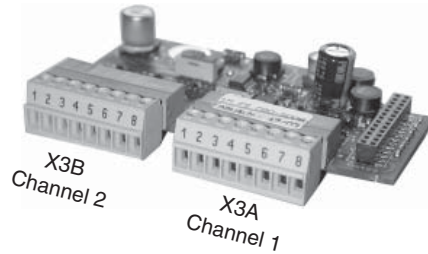

ONLY when the inverter is switched off and the voltage supply is disconnected may the feedback connectors be removed or connected!

Plug in screw terminal X3A



Pin No.	Signal	Description
1	A+	TTL incremental encoder track A
2	A-	Differential signal to A+
3	B+	TTL incremental encoder track B
4	B-	Differential signal to B+
5*	N+	TTL Zero track
6*	N-	Difference signal to N+
7**	15/24 V	Voltage output 15/20...30V, power supply for the encoder, switchable with dip switch S100
8	COM	0V reference for voltage supply
-	GND	Connect the outer cable shield to an earth ground connection on the elevator drive



***If the encoder has no zero channel, connect N+ (X3A.5) to 5V (X3B.7) and N- (X3A.6) to 0V common (X3B.8) to avoid 'Error Encoder1' faults.**

****For 5V supply TTL encoders, a 5V supply is available on the second interface channel, X3B.7.**

TTL Incremental Terminal Strip - Encoder Connections

The following specifications apply to encoder interface X3A, channel 1

- Max. operating frequency: 300 kHz.
- Internal terminating resistance: $R_t = 120 \Omega$
- RS422 or TTL level square wave voltage level: 2...5 Vdc

Input equivalent circuit

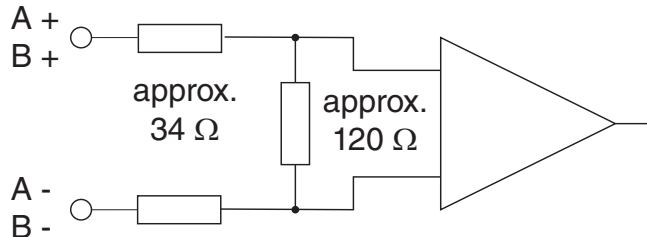

Selection of the supply voltage

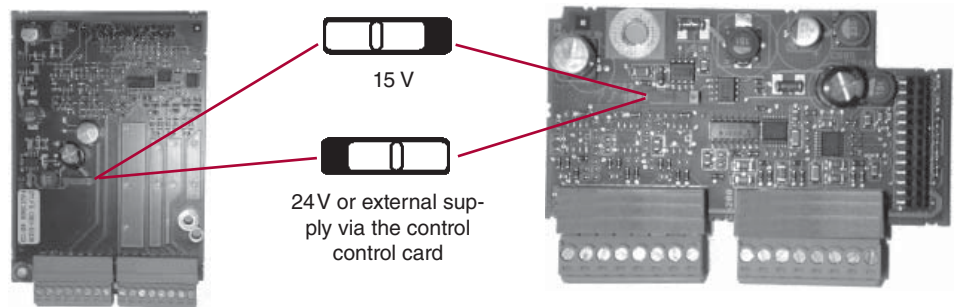

The maximum load capacity is dependant on the selected voltage supply.

- Max. load capacity with 15V internal supply: 300 mA
- Max. load capacity with 24V internal supply: 170 mA
- Max. load capacity with an external 24V supply 1A (dependent on the external voltage source)

The specified currents are reduced by any current drawn on the second interface X3B (see Section 3.3.9).

For maximum noise immunity, the encoder cable shall consist of individually shielded twisted pairs with one overall shield. The individual shields should be connected to 0V (com) pin 8 on the X3A terminal strip and be kept electrically isolated from the outer shield. The outer shield should be connected to earth ground on the elevator drive.



The cable shall be kept a minimum of 8 inches (20 cm) away from all wires having greater than 24VDC on them. For best results run the encoder cable in a separate conduit from the controller to the motor.

3.3.2 EnDat Encoder Interface X3A

The EnDat encoder provides two differential analog channels for incremental position and one serial data channel with clock for communication with the encoder. This serial data channel can provide the drive with the absolute position of the motor as well as other operating data. The EnDat encoder must be version 2.1 or greater for compatibility reasons; EnDat 2.2 and only digital EnDat 2.1 utilize the EnDat 2.2 / BiSS interface, Section 3.3.5.

The analog cosine and sine wave signals of tracks A and B have a voltage of 1 Vpp with an Offset of 2.5 V. This analog voltage is measured and a high resolution position value is determined as a result. This high resolution position value is very important for good speed control of a gearless motor.



Therefore it is absolutely necessary to ensure these signals are well shielded! Noise on the analog signals resulting from breaks in the shield or improper shield termination will result in vibration in the motor and poor ride quality.

The internal stored ppr value is compared to the adjusted value in LE02. If the two are not the same the drive will trigger the 'Error Encoder Interface' fault. Refer to parameter LE12 for more information.

During start-up and then every 30 ms a request is transmitted to the encoder and the absolute position is read out via serial communication. This initial readout of the absolute position provides the drive with the commutation angle for permanent magnet motors. On the very first operation of a permanent magnet motor it is necessary to synchronize the encoder position to one of the pole pairs of the motor. See parameter LE06 for more information and section 5.10.

During normal operation, the difference between the internal absolute position of the encoder and the measured position value in the drive is compared. If the two deviate by more than 2.8 degrees, the drive will trigger the 'Error Encoder Interface' fault. Refer to parameter LE12 for more information.

The clock signal serves as synchronization for the serial data channel.

If there is an excess length of cable (10 feet or less), it is OK to coil it into a loop in the controller. Maintain a minimum diameter of 1 foot and keep the cable at least 8 inches away from all high voltage power wires.

EnDat - Encoder Connections

ENDAT Drive connection X3A Female SUBD 15 HD

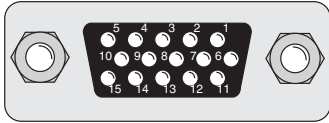

Pin No.	Signal	Description
3	A-	Signal input A- (difference signal to COS+)
4	B-	Signal input B- (difference signal to SIN+)
6	CLOCK +	Synch. signal for serial data
7	CLOCK -	Synch. signal for serial data
8	A+	SIN+ signal input A (absolute track for counter and direction detection)
9	B+	COS+ signal input B (absolute track for counter and direction detection)
12	+ 5V	Supply voltage for encoder
13	COM	Reference potential for supply voltage
14	DATA -	Data channel RS485
15	DATA +	Data channel RS485



ONLY when the inverter is switched off and the voltage supply is disconnected may the feedback connectors be removed or connected!

- Max. Load capacity depending on Voltage Supply
- Max. Load capacity at +5.0V; 300 mA. The specified current is reduced by the current taken from the second encoder interface X3B interface (see Section 3.3.9).

EnDat Cable

Pre-manufactured EnDat cables offer the best solution against noise and disturbance while at the same time saving installation time. The cables come in standard lengths of 5m, 10m, 15m, 20m, 25m and 30m. Specially designed cables are available for applications 40m, 50, 75 and 85m. **The maximum length of KEB cable offered is 85m.**

Cable Part Number

00.F5.0C1-40xx xx = length in meters, 10 = 10 meters

For lengths above 30 m a different cable is used.

00.F5.0C1-L0xx xx = length in meters, 40 = 40 meters

Mating Connector

00.90.912-004U for encoder (solder type)

Running in Conduit

When this cable must be pulled through metallic conduit, it is necessary to over size the conduit!

Use of a 1 1/2 inch trade size conduit will allow the connectors to pass without removal of the connectors. Cutting the cable, or removal of the connectors or their housings voids the warranty and will result in problems with electrical noise after the fact.

Circular connector on EnDat encoder.

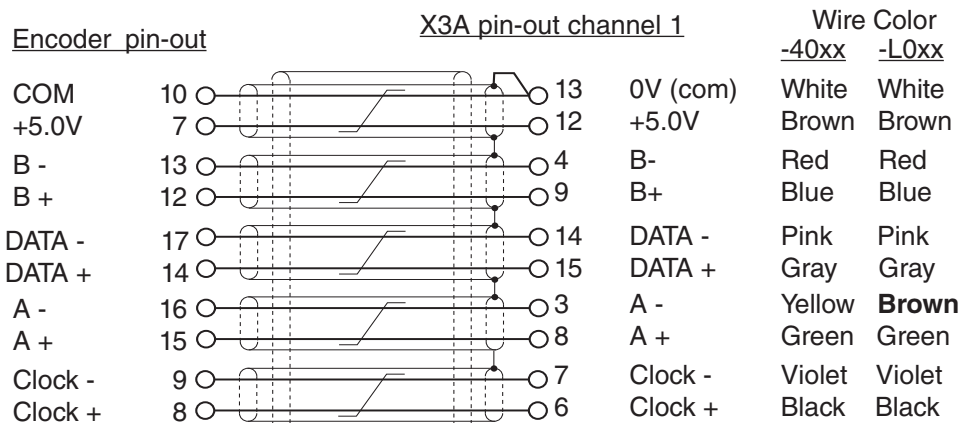
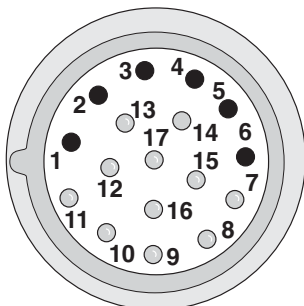

Shield wire tied to housing

Shield wires tied to housing which is earth ground.

Note: Inner pair shields are tied to 0V (com), pin 13, not earth ground!

Technical Data

- Input resistance: 120 Ohm
- Process data channel: 1Vpp
- Parameter channel: EIA RS485 half duplex
- Clock signal output: EIA RS485
- Maximum input frequency: 200 kHz
- Encoder line number: 1...2048 inc
- Maximum cable length: 100 m *(based on signal levels, otherwise see below)*

Cable length based on cable resistance

The maximum cable length is calculated as follows:

$$\text{Length} = \frac{V - V_{\min}}{I_{\max} * R} = \frac{5.25V - 4.75V}{0.2A * 0.03 \Omega/m} = 83.3 \text{ m}$$

where

I_{\max} = supply current of encoder [amps]

V = voltage supply of the drive = 5.25V

V_{\min} = minimum supply voltage of the encoder

R = cable resistance (0.07 Ω/m) for Standard KEB cables
(0.03 Ω/m) for type "L" KEB cables

The following ENDAT encoders have been tested for use:

- **Heidenhain ECN 1313, 413, 113 single turn**

However, this does not restrict the use of rotary encoder with same specifications of other manufacturers

The recognition of encoder loss or exchange is a software function and dependent on the encoder type. If the drive senses that the serial communication to the encoder has stopped, it will trigger the 'Error Encoder Interface' fault.



If the encoder is replaced or disconnected, the drive will trigger an error or warning that the encoder was changed. The drive will display the error message 'Error Encoder Interface'.

If the encoder was exchanged the drive will auto reset the 'Error Encoder Interface' fault. The user will need to learn the new encoder position before operation can continue. See section 5.10.

If there is an encoder triggered fault or problems with the encoder cable the 'Error Encoder Interface' fault will not clear and the problems must be diagnosed through parameter LE12. To clear the 'Error Encoder Interface' fault, it is necessary to go to parameter LE01, press "Enter" and then press "Enter" again to confirm.

Sin/Cos - Encoder Connections

3.3.3 Sin/Cos Encoder Interface X3A

The Sin/Cos encoder provides two differential analog channels for incremental position and two differential analog channels for the absolute position of the motor

The analog cosine and sine wave signals of tracks A and B have a voltage of 1 Vpp with an Offset of 2.5 V. This analog voltage is measured and a high resolution position value is determined as a result. This high resolution position value is very important for good speed control of a gearless motor. Tracks C and D give an absolute signal to the control unit. The period is correspond exactly to one mechanical revolution of the encoder.



Therefore it is absolutely necessary to ensure these signals are well shielded! Noise on the analog signals resulting from breaks in the shield or improper shield termination will result in vibration in the motor and poor ride quality.

During start-up and then every 30 ms a position value is read from the absolute tracks. This initial readout of the absolute position provides the drive with the commutation angle for permanent magnet motors.

If no absolute and/or zero track is recognized during power-on, these functions are deactivate. Operation with exclusively utilization of the high resolution tracks A and B is possible.

On the very first operation of a permanent magnet motor it is necessary to synchronize the encoder position to one of the pole pairs of the motor. See parameter LE06 for more information and section 5.10.

During normal operation, the difference between the internal absolute position of the encoder and the measured position value in the drive is compared. If the two deviate by more than 2.8 degrees, the drive will trigger the 'Error Encoder Interface' fault. Refer to parameter LE12 for more information.

If there is an excess length of cable (10 feet or less), it is OK to coil it into a loop in the controller. Maintain a minimum diameter of 1 foot and keep the cable at least 8 inches away from all high voltage power wires.

Sin/Cos
Drive connection X3A
Female SUBD 15 HD

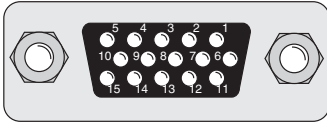

Pin No.	Signal	Description
1	C-	Differential signal to C+
2	D-	Differential signal to D+
3	A-	Differential signal to A+
4	B-	Differential signal to B+
6	C+	SIN+ Absolute track for initial position and angular calculation
7	D+	COS+ Absolute track for initial position and angular calculation
8	A+	COS+ Incremental signals A for counter and direction detection
9	B+	SIN+ Incremental signals B for counter and direction detection
12	+5.25V	Power supply for encoder
13	COM	Reference potential for supply voltage
14	R-	Differential signal to zero track R+
15	R+	Zero track

! ONLY when the inverter is switched off and the voltage supply is disconnected may the feedback connectors be removed or connected!

- Max. Load capacity depending on Voltage Supply
- Max. Load capacity at +5.0V; 300 mA. The specified current is reduced by the current taken from the second encoder interface X3B interface (see Section 3.3.9).

Pre-manufactured Sin/Cos cables offer the best solution against noise and disturbance while at the same time saving installation time. The cables come in standard lengths of 5m, 10m, 15m, 20m, 25m and 30m. Specially designed cables are available for applications 40m and up. The maximum length of KEB cable offered is 50m.

Cable Part Number

00.S4.209-00xx xx = length in meters, 10 = 10 meters

Mating Connector

00.90.912-004U for encoder (solder type)

Running in Conduit

When this cable must be pulled through metallic conduit, it is necessary to over size the conduit!

Use of a 1 1/2 inch trade size conduit will allow the connectors to pass without removal of the connectors. Cutting the cable, or removal of the connectors or their housings voids the warranty and will result in problems with electrical noise after the fact.

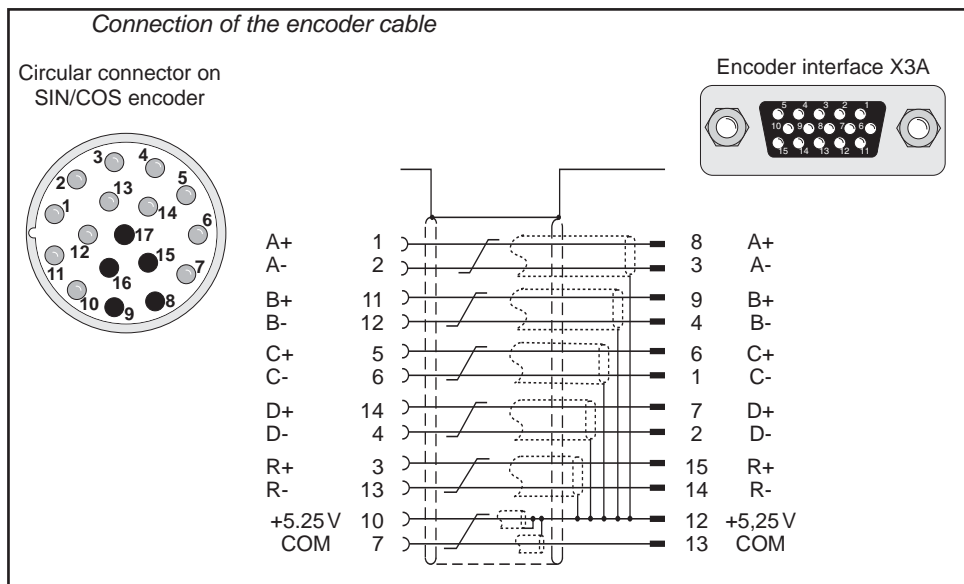

Sin/Cos - Encoder Connections

Technical Data

- Input resistance: 120 Ohm
- Process data channel: 1Vpp
- Maximum input frequency: 200 kHz
- Encoder line number: 1...2048 inc
- Maximum cable length: 100 m (*based on signal levels, otherwise see below*)
- Cable length based on cable resistance

The maximum cable length is calculated as follows:

$$\text{Length} = \frac{V - V_{\text{min}}}{I_{\text{max}} * R} = \frac{5.25\text{V} - 4.75\text{V}}{0.2\text{A} * 0.03 \Omega/\text{m}} = 83.3 \text{ m}$$

where

I_{max} = supply current of encoder [amps]

V = voltage supply of the drive = 5.25V

V_{min} = minimum supply voltage of the encoder

R = cable resistance (0.07 Ω/m) for Standard KEB cables
(0.03 Ω/m) for type "L" KEB cables

The following Sin/Cos encoders have been tested for use:

- Heidenhain ERN 1387, 487

However, this does not restrict the use of rotary encoder with same specifications of other manufacturers

The recognition of encoder loss or exchange is a software function and dependent on the encoder type. If the drive senses that the serial communication to the encoder has stopped, it will trigger the 'Error Encoder Interface' fault.



If there is an encoder triggered fault or problems with the encoder cable the 'Error Encoder Interface' fault will not clear and the problems must be diagnosed through parameter LE12. To clear the 'Error Encoder Interface' fault, it is necessary to go to parameter LE01, press "Enter" and then press "Enter" again to confirm.

3.3.4 SSi Encoder Interface X3A

The SSi encoder provides two differential analog channels for incremental position and one serial data channel with clock for communication with the encoder. This serial data channel can provide the drive with the absolute position of the motor.

The analog cosine and sine wave signals of tracks A and B have a voltage of 1 Vpp with an Offset of 2.5 V. This analog voltage is measured and a high resolution position value is determined as a result. This high resolution position value is very important for good speed control of a gearless motor.



Therefore it is absolutely necessary to ensure these signals are well shielded! Noise on the analog signals resulting from breaks in the shield or improper shield termination will result in vibration in the motor and poor ride quality.



The inputs for A and B tracks are designed for sinusoidal waveforms, as shown in Section 3.3. TTL waveforms are possible with adapter ADF5080-V009.

During start-up and then every 30 ms a request is transmitted to the encoder and the absolute position is read out via serial communication. This initial readout of the absolute position provides the drive with the commutation angle for permanent magnet motors. On the very first operation of a permanent magnet motor it is necessary to synchronize the encoder position to one of the pole pairs of the motor. See parameter LE06 for more information and section 5.10.

During normal operation, the difference between the internal absolute position of the encoder and the measured position value in the drive is compared. If the two deviate by more than 2.8 degrees, the drive will trigger the 'Error Encoder Interface' fault. Refer to parameter LE12 for more information.

The clock signal serves as synchronisation for the serial data channel.

If there is an excess length of cable (10 feet or less), it is OK to coil it into a loop in the controller. Maintain a minimum diameter of 1 foot and keep the cable at least 8 inches away from all high voltage power wires.

SSi - Encoder Connections

SSi Drive connection X3A Female SUBD 15 HD

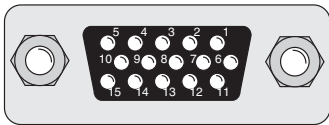

Pin No.	Signal	Description
3	A-	signal input A- (difference signal to COS+)
4	B-	signal input B- (difference signal to SIN+)
6	CLOCK +	synch. signal for serial data
7	CLOCK -	synch. signal for serial data
8	A+	COS+ signal input A (absolute track for counter and direction detection)
9	B+	SIN+ signal input B (absolute track for counter and direction detection)
12	+ 5V	Supply voltage for encoder
13	COM	reference potential for supply voltage
14	DATA -	Data channel RS485
15	DATA +	Data channel RS485



ONLY when the inverter is switched off and the voltage supply is disconnected may the feedback connectors be removed or connected!

- Max. Load capacity depending on Voltage Supply
- Max. Load capacity at +5.0V; 300 mA. The specified current is reduced by the current taken from the second encoder interface X3B interface (see Section 3.3.9).

SSi Cable

Pre-manufactured SSi cables offer the best solution against noise and disturbance while at the same time saving installation time. The cables come in standard lengths of 5m, 10m, 15m, 20m, 25m and 30m.

Cable Part Number

00.F5.0C1-40xx xx = length in meters, 10 = 10 meters

Mating Connector

00.90.912-004U for encoder (solder type)

Running in Conduit

When this cable must be pulled through metallic conduit, it is necessary to over size the conduit! Use of a 1 1/2 inch trade size conduit will allow the connectors to pass without removal of the connectors. Cutting the cable, or removal of the connectors or their housings voids the warranty and will result in problems with electrical noise after the fact.

Circular connector on SSi encoder.

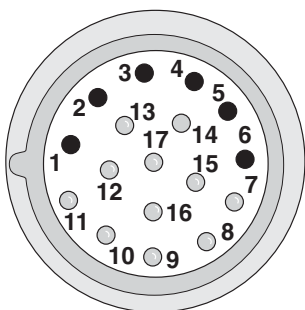

Encoder pin-out

X3A pin-out channel 1

Wire color

COM	10	13	0V (com)	white
+5.0V	7	12	+5.0V	brown
B -	13	4	B-	red
B +	12	9	B+	blue
DATA -	17	14	DATA -	pink
DATA +	14	15	DATA +	gray
A -	16	3	A-	yellow
A +	15	8	A +	green
Clock -	9	7	Clock -	violet
Clock +	8	6	Clock +	black

Shield wire tied to housing

Shield wire tied to housing which is earth ground.

Note: Inner pair shields are tied to 0V (com), pin 13, not earth ground!

Technical Data

- Input resistance: 120 Ohm
- Process data channel: 1Vpp
- Parameter channel: EIA RS485 half duplex
- Clock signal output: EIA RS485
- Maximum input frequency: 200 kHz
- Encoder line number: 1...2048 inc
- Maximum cable length: 100 m (*based on signal levels, otherwise see below*)

Cable length based on cable resistance

The maximum cable length is calculated as follows:

$$\text{Length} = \frac{V - V_{\min}}{I_{\max} * R} = \frac{5.25V - 4.75V}{0.2A * 0.03 \Omega/m} = 83.3 \text{ m}$$

where

I_{\max} = supply current of encoder [amps]

V = voltage supply of the drive = 5.25V

V_{\min} = minimum supply voltage of the encoder

R = cable resistance (0.07 Ω/m) for Standard KEB cables
(0.03 Ω/m) for type "L" KEB cables

The following SSi encoders have been tested for use:

- Hengstler AD-36

However, this does not restrict the use of rotary encoder with same specifications of other manufacturers



The inputs for A and B tracks are designed for sinusoidal waveforms, as shown in Section 3.3. TTL waveforms are possible with adapter ADF5080-V009.

The recognition of encoder loss or exchange is a software function and dependent on the encoder type. If the drive senses that the serial communication to the encoder has stopped, it will trigger the error E.ENCC.



If the encoder is replaced or disconnected, the drive will trigger an error or warning that the encoder was changed. The drive will display the 'Error Encoder Interface' fault

If the encoder was exchanged the drive will auto reset the 'Error Encoder Interface' fault. The user will need to learn the new encoder position before operation can continue. See section 5.10.

If there is an encoder triggered fault or problems with the encoder cable the 'Error Encoder Interface' fault will not clear and the problems must be diagnosed through parameter LE12. To clear the 'Error Encoder Interface' fault, it is necessary to go to parameter LE01, press "Enter" and then press "Enter" again to confirm.

BiSS / EnDat 2.2 - Encoder Connections

3.3.5 BiSS / EnDat 2.2 Encoder Interface X3A

The BiSS/EnDat 2.2 encoder supports encoders with bidirectional serial communication for incremental and absolute position with high transfer rates.

The encoder provides one serial data channel with clock for communication with the encoder. The clock signal serves as synchronization for the serial data channel. This serial data channel can provide the drive with the absolute position of the motor as well as other operating data.

The encoder protocol must be adjusted with parameter LE14.

Setting:	NUM
EnDat 2.2	0
BiSS Hengstler Acuro	1
BiSS C-Mode	2

During start-up and run, a request is transmitted to the encoder and the absolute position is read out via serial communication. This initial readout of the absolute position provides the drive with the commutation angle for permanent magnet motors. On the very first operation of a permanent magnet motor it is necessary to synchronize the encoder position to one of the pole pairs of the motor. See parameter LE06 for more information and section 5.10.



Due to the high clock frequencies, it is absolutely necessary to ensure these signals are well shielded!

BiSS / EnDat 2.2 Drive connection X3A Screw Terminal Strip

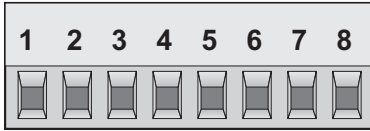

Pin No.	Signal	Description
1	DATA +	Data Channel +
2	DATA -	Data Channel -
3	CLOCK +	Clock Channel +
4	CLOCK -	Clock Channel -
5	-	
6	5V	5.25V voltage output for encoder supply
7	24V	24V voltage output for encoder supply
8	COM	Reference potential for voltage supply
-	GND	Function earth is not available at the terminal block and must be connected at appropriate place at the unit.

! ONLY when the inverter is switched off and the voltage supply is disconnected may the feedback connectors be removed or connected!

- Max. Load capacity depending on Voltage Supply
- Max. Load capacity at +5.25V = 300 mA; 24V = 1A. The specified current is reduced by the current taken from the second encoder interface X3B interface (see Section 3.3.9).

BiSS/EnDat 2.2

Pre-manufactured BiSS/EnDat 2.2 cables offer the best solution due to high clock frequencies and protection against noise and disturbance while at the same time saving installation time. **The maximum length is 50m.**

Cable Part Number

00.F5.0C1-B0xx xx = length in meters, 10 = 10 meters

Mating Connector

00.90.912-004U for encoder (solder type)

Running in Conduit

When this cable must be pulled through metallic conduit, it is necessary to over size the conduit! Use of a 1 1/2 inch trade size conduit will allow the connectors to pass without removal of the connectors. Cutting the cable, or removal of the connectors or their housings voids the warranty and will result in problems with electrical noise after the fact.

Circular connector on EnDat 2.2/BiSS encoder.

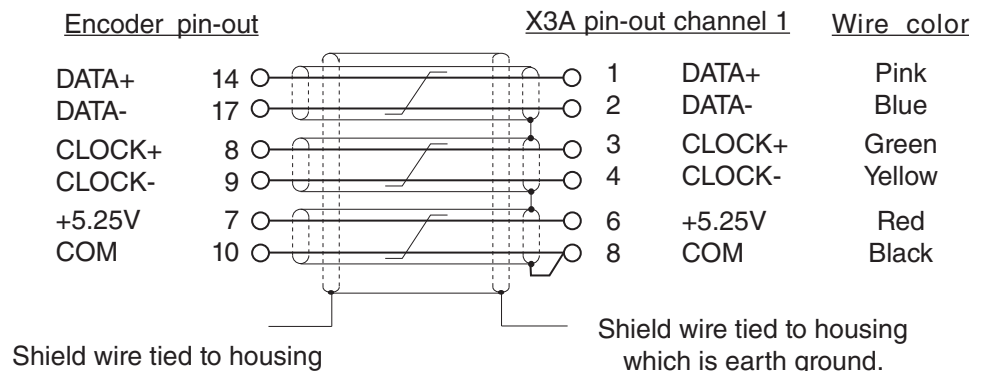
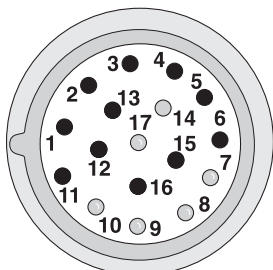

Note: Inner pair shields are tied to 0V (com), not earth ground!

BiSS / EnDat 2.2 - Encoder Connections

Technical Data

Interface Type	EnDat 2.2 / BiSS		
Input Signals	5V TTL, Data and Clock according to RS-422/485		
Inputs / Tracks	EnDat		BiSS
	Data channel SSI bi-directional, half duplex		Data channel. SSI uni-directional
	Clock Frequency	EnDat 2.1 = 1 MHz EnDat 2.2 = 4.16 MHz	3.125 MHz
Resolution (Singleturn)	Depending on the encoder, max. 24-bit. If the resolution of the encoder is higher, the least significant, additional bits are deleted.		
Resolution (Multiturn)	Max. 15-bit		
Input Resistance	150 Ohm		
Max. Line Length	50m, the value is additionally limited by the signal frequency, cable capacity and supply voltage		

The following encoders have been tested for use:

EnDat: Heidenhain ECN 425, 1325, 125, ROQ437, ECI1317, EQN1125
BiSS: Hengstler Acuro AD58, AD36, AD34; Lika HSC 5918

However, this does not restrict the use of rotary encoder with same specifications of other manufacturers

The recognition of encoder loss or exchange is a software function and dependent on the encoder type. If the drive senses that the serial communication to the encoder has stopped, it will trigger the error E.ENCC.



If the encoder is replaced or disconnected, the drive will trigger an error or warning that the encoder was changed. The drive will display the 'Error Encoder Interface' fault

If the encoder was exchanged the drive will auto reset the 'Error Encoder Interface' fault. The user will need to learn the new encoder position before operation can continue. See section 5.10.

If there is an encoder triggered fault or problems with the encoder cable the 'Error Encoder Interface' fault will not clear and the problems must be diagnosed through parameter LE12. To clear the 'Error Encoder Interface' fault, it is necessary to go to parameter LE01, press "Enter" and then press "Enter" again to confirm.

3.3.6 Hiperface Encoder Interface X3A

The Hiperface encoder provides two differential analog channels for incremental position and one serial data channel for communication with the encoder. This serial data channel can provide the drive with the absolute position of the motor as well as other operating data.

The analog cosine and sine wave signals of tracks A and B have a voltage of 1 Vpp with an Offset of 2.5 V. This analog voltage is measured and a high resolution position value is determined as a result. This high resolution position value is very important for good speed control of a gearless motor.



Therefore it is absolutely necessary to ensure these signals are well shielded! Noise on the analog signals resulting from breaks in the shield or improper shield termination will result in vibration in the motor and poor ride quality.

The internal stored ppr value is compared to the adjusted value in LE02. If the two are not the same the drive will trigger the 'Error Encoder Interface' fault. Refer to parameter LE12 for more information.

During start-up and then every 100 ms a request is transmitted to the encoder and the absolute position is read out via serial communication. This initial readout of the absolute position provides the drive with the commutation angle for permanent magnet motors. On the very first operation of a permanent magnet motor it is necessary to synchronize the encoder position to one of the pole pairs of the motor. See parameter LE06 for more information and section 5.10.

During normal operation, the difference between the internal absolute position of the encoder and the measured position value in the drive is compared. If the two deviate by more than 2.8 degrees, the drive will trigger the 'Error Encoder Interface' fault. Refer to parameter LE12 for more information.

If there is an excess length of cable (10 feet or less), it is OK to coil it into a loop in the controller. Maintain a minimum diameter of 1 foot and keep the cable at least 8 inches away from all high voltage power wires.

Hiperface - Encoder Connections

HIPERFACE Drive connection X3A Female SUBD 15 HD

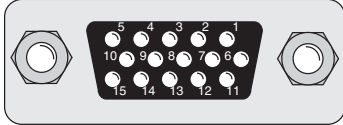

Pin No.	Signal	Description
3	A-	signal input A- (difference signal to COS+)
4	B-	signal input B- (difference signal to SIN+)
8	A+	COS+ signal input A (absolute track for counter and direction detection)
9	B+	SIN+ signal input B (absolute track for counter and direction detection)
10	+7.5V	Supply voltage for encoder
13	COM	reference potential for supply voltage
14	DATA -	Data channel RS485
15	DATA +	Data channel RS485



ONLY when the inverter is switched off and the voltage supply is disconnected may the feedback connectors be removed or connected!

- Max. Load capacity depending on Voltage Supply
- Max. Load capacity at +7.5 V = 300 mA. The specified current is reduced by the load current taken from the second encoder interface X3B interface (see Section 3.3.9).

HIPERFACE Cable

Pre-manufactured Hiperface cables offer the best solution against noise and disturbance while at the same time saving installation time. The cables come in standard lengths of 5m, 10m, 15m, 20m, 25m, and 30m.

Cable Part Number

00.S4.809-00xx xx = length in meters, 10 = 10 meters

Mating Connector

00.90.912-003U for encoder (solder type)

Running in Conduit

When this cable must be pulled through metallic conduit, it is necessary to over size the conduit! Use of a 1 1/2 inch trade size conduit will allow the connectors to pass without removal of the connectors. Cutting the cable, or removal of the connectors or their housings voids the warranty and will result in problems with electrical noise after the fact.

Circular connector on Hiperface encoder.

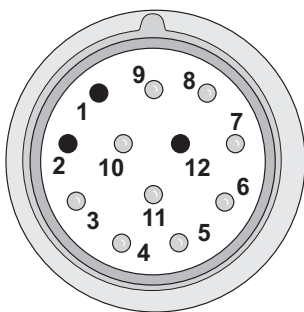

Encoder pin-out

X3A pin-out channel 1

Wire color

GND	11	13	0V (com)	White
+7.5V	10	10	+7.5V	Brown
B -	4	4	B -	Red
B +	8	9	B +	Blue
DATA -	7	14	DATA -	Pink
DATA +	6	15	DATA +	Gray
A -	5	3	A -	Yellow
A +	9	8	A +	Green

Shield wire tied to housing

Shield wire tied to housing

Note: Inner pair shields are tied to 0V (com), pin 13, not earth ground!

which is earth ground.

Technical Data

- Input resistance: 120 Ohm
- Process data channel: 1Vpp
- Parameter channel: EIA RS485 half duplex
- Maximum input frequency: 200 kHz
- Encoder line number: 1024 inc
- Maximum cable length: <100 m *(based on signal levels, otherwise see below)*

Cable length based on cable resistance

The maximum cable length is calculated as follows:

$$\text{Length} = \frac{V - V_{\min}}{I_{\max} * R} = \frac{7.5V - 7.0}{0.2A * 0.07 \Omega/m} = 35.7 \text{ m}$$

where

I_{\max} = supply current of encoder [amps]

V = voltage supply of the drive = 7.5V

V_{\min} = minimum supply voltage of the encoder

R = cable resistance (0.07 Ω/m) for KEB cables

The following Hiperface®-encoders have been tested for use:

- Stegmann SRS 50/60 Singleturn; SCS 60/70 Singleturn
- Stegmann SRM 50/60 Multiturn; SCM 60/70 Multiturn

However, this does not restrict the use of rotary encoder with same specifications of other manufacturers

Recognition of encoder loss or exchange

The recognition of encoder loss or exchange is a software function and dependent on the encoder type. If the drive senses that the serial communication to the encoder has stopped, it will trigger the 'Error Encoder Interface' fault.



If the encoder is replaced or disconnected, the drive will trigger an error or warning that the encoder was changed. The drive will display the error message 'Error Encoder Interface'.

If the encoder was exchanged the drive will auto reset the 'Error Encoder Interface' fault. The user will need to learn the new encoder position before operation can continue. See section 5.10.

If there is an encoder triggered fault or problems with the encoder cables, the 'Error Encoder Interface' fault will not clear and the problems must be diagnosed through parameter LE12. To clear the 'Error Encoder Interface' fault, it is necessary to go to parameter LE01, press "Enter" and then press "Enter" again to confirm.

UVW - Encoder Connections

3.3.7 UVW Encoder Interface X3A

The UVW encoder provides two differential analog channels for incremental position and three analog channels for the absolute position of the motor.

Tracks A and B are incremental TTL signals with a maximum of 5,000 increments per revolution.

The zero track N track is not evaluated.

Tracks U, V, and W are absolute block commutation TTL signals.



The pole-pair number of the motor and encoder (the periods of the UVW tracks) must be equal. If not, it may be possible to adjust the number of UVW encoder commutation poles in LE13.

The order of the rising edge of the block commutation tracks must be U, W, V with the reference being clockwise rotation as viewed from the motor facing the encoder. If the encoder channels are specified to have a different progression, then the corresponding channels must be exchanged (eg. if U,V,W = 1,2,3, then V+, V- and W+, W- channels must be swapped).

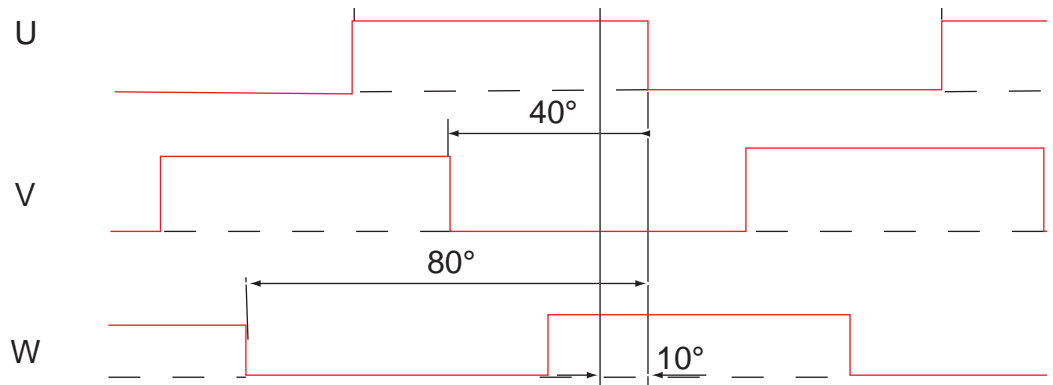

The levels of the U, V, W signals are measured after switching on and thus the absolute position of the encoder is determined within an electrical revolution of the motor (eg. revolution of the absolute tracks UVW). This position can maximally vary with 30° of the electrical revolution. The current position is first set to this start position. If the motor starts to turn and the first rising edge at the U, V or W track is overdriven, the exact absolute position is determined and the current position is corrected to this value. Only the rising edge of the W track is evaluated for the position correction during normal operation.

UVW
Drive connection X3A
Female SUBD 15 HD

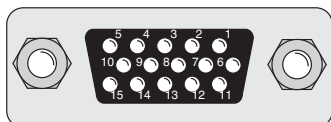

Pin No.	Signal	Description
1	A+	Incremental encoder input track A
2	A-	Differential signal to A+
3	B+	Incremental encoder input track
4	B-	Differential signal to B+
5	N+	Input zero track (not evaluated)
6	N-	Differential signal to N+ (not evaluated)
7	U+	Block commutation track U
8	U-	Differential signal to U+
9	V+	Block commutation track
10	V-	Differential signal to V+
11	W+	Block commutation track
12	W-	Differential signal to W+
13	5V	Voltage output 5V
14	COM	Reference potential for voltage supply
15	-	-

ONLY when the inverter is switched off and the voltage supply is disconnected may the feedback connectors be removed or connected!

- Max. Load capacity depending on Voltage Supply
- Max. Load capacity at +5.2V = 400 mA. The specified current is reduced by the current taken from the second encoder interface X3B interface (see Section 3.3.9).

Technical Data

- Input resistance: 120 Ohm
- Maximum input frequency: 200 kHz
- Encoder line number: 1...5000 inc

The following Sin/Cos encoders have been tested for use:

- Heidenhain ERN 423, 426
- Quantum Devices Q-Phase

However, this does not restrict the use of rotary encoder with same specifications of other manufacturers.

TTL Incremental SubD - Encoder Connections

3.3.8 Incremental TTL Encoder Interface X3A SubD

Connect the incremental encoder mounted on the motor to the 15-pin Sub-D connector at X3A. This connection provides speed feedback and is imperative to the proper operation of the F5.

 **ONLY when the inverter is switched off and the voltage supply is disconnected may the feedback connectors be removed or connected!**

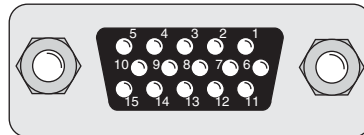

Pin No.	Signal
3	A-
4	B-
8	A+
9	B+
11	V _{var} 24...30 V
12	+5.2 V
13	0V (com)
14	N-
15	N+
Shield	Housing

The internal voltage of "V_{var}" 24...30 V ⁽¹⁾ is an unregulated supply and will allow up to 170mA max. current draw, for X3A and X3B total. If higher voltages / currents are required, then an external power supply must be provided.

The +5.2 V is a regulated voltage supply generated from V_{var} and will allow up to 500mA max. current draw, for X3A and X3B total. If additional current is required from the +5.2 V output, the current from V_{var} decreases in accordance with following formula:

$$I_{var} = 170 \text{ mA} - \frac{5.2 \text{ V} \times I_{+5V}}{V_{var}}$$

The following specifications apply to encoder interface X3A and X3B, channel 1 and 2, respectively:

- Max. operating frequency: 300 kHz.
- Internal terminating resistance: R_t = 120 Ω
- RS422 or TTL level square wave voltage level: 2...5 Vdc

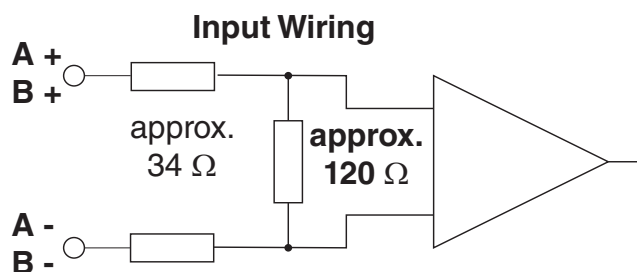

1. Maximum Encoder voltage: +5.2 V

2. Encoder line number: 1...16383 ppr
 2500 ppr is recommended and gives best speed resolution and regulation performance for applications with a maximum motor speed of up to 4500 rpm.

F5 Interface cutoff frequency: 300 kHz
 Observe cutoff frequency of the encoder:

$$f_{\text{limit}} > \frac{g \cdot n_{\text{max}}}{60}$$

g = Encoder increments (ppr)
 n = Encoder speed (rpm)
 f = Encoder operating frequency (Hz)

3. Signal specifications:

Four signals consisting of two square-wave pulses that are electrically 90° out of phase and their inverse signals (TTL-push-pull signals / RS422-conformity). Minimum "on" voltage level is 2.0V and maximum "off" voltage level is 0.5V. The encoder must be electrically isolated from the motor shaft. Otherwise noise from the motor may corrupt the encoder signals.

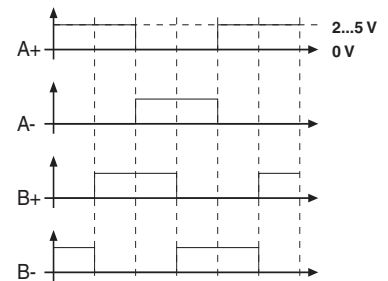

4. Cable specifications:

The encoder cable shall not be too long such that the voltage drop of supply voltage on the encoder cable results in a voltage less than the minimum encoder supply voltage. Typically encoder lines should not be longer than 160 ft (50 m). The following must be valid for trouble free operation.

$$[(I_{\text{Encoder}} \cdot R_{\text{Line}}) + V_{\text{Encoder (min)}}] < +5.2 \text{ V}$$

R_{Line} is the sum of the resistance of the supply wires both +V and com.

For maximum noise immunity, the encoder cable shall consist of individually shielded twisted pairs with one overall shield. The individual shields should be connected to 0V (com) pin 13 on the Sub D connector and be kept separate from the outer shield. The outer shield should be connected to earth ground, the housing of the Sub D connector.



The cable shall be kept a minimum of 8 inches (20 cm) away from all wires having greater than 24VDC on them. For best results run the encoder cable in a separate conduit from the controller to the motor.

Output - Encoder Connections

3.3.9 X3B Output TTL Incremental



ONLY when the inverter is switched off and the voltage supply is disconnected may the feedback connectors be removed or connected!

The second incremental encoder connection serves as a buffered output of the motor encoder. This can be used by other control systems for speed or position control. The output signals are according to the RS422 line driver signal standard.

Plug in screw terminal



9 Pin Sub D - Female

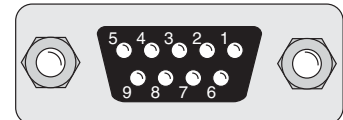

Pin No. (Terminal)	Signal	Pin No. (SubD)
1	A+	1
3	B+	2
5	N+	3
7	+5.0V	4
-	24 ... 30V	5
2	A-	6
4	B-	7
6	N-	8
8	0V Com	9
Inverter Housing	Earth GND	Sub-D Housing

The internal 24VDC power supply has a maximum load capacity of 170mA . The 5V supply has a maximum load capacity of 500mA. Both of these values assume no loading on the supplies of connection X3A. If connections or loads are placed on both terminals, the total load between the two must not exceed these values.

The following specifications apply to encoder interface X3B, channel 2

- Max. operating frequency: 200 kHz.
- External terminating resistance: $R_t = 120 \text{ Ohm}$
- RS422 level square wave voltage level: 2...4 Vdc



For proper noise immunity, the RS422 standard requires a termination resistor be placed at the device which is receiving the simulated encoder signal. The resistors shall be connected from A+ to A-, B+ to B-, N+ to N- (only when used).

4. Operation of the unit

4.1 LCD Operator

The KEB Elevator drive uses a special operator keypad which provides a user interface and functionality specific to elevator applications. The operator must be plugged into the drive in order for the drive to function properly.



Unplugging the operator while the drive is in operation will result in an immediate shutdown of the drive and will cause the ready relay to drop and the fault output to activate.

If it is necessary to remove the operator, do so while the elevator is standing still!

The KEB Elevator LCD Operator comes in 2 different hardware versions:

1. SD Card (v3.00 only) (KEB Part#: 00F5060-KL00)
2. Serial - CAN/RS485 (KEB Part#: 00F5060-KL10)

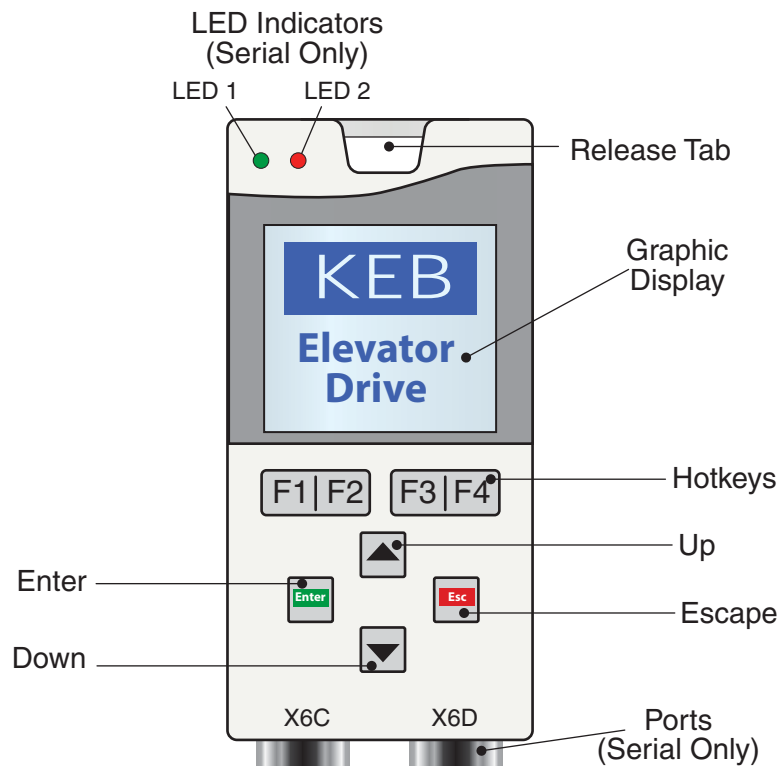

4.1.1 Keypad Buttons

Button	Name	Function
	Up/Down	Increment/Decrement through menu or values
	Enter	Selects a parameter or group, Enters <i>Edit Mode</i> , Save parameter setting
	Escape	Backs out of parameter group or exits <i>Edit Mode</i>
	Hotkeys	Keys correspond to display LCD text above Allows a user to quickly jump menus

LCD Keypad

4.2 Serial/CAN Hardware Version

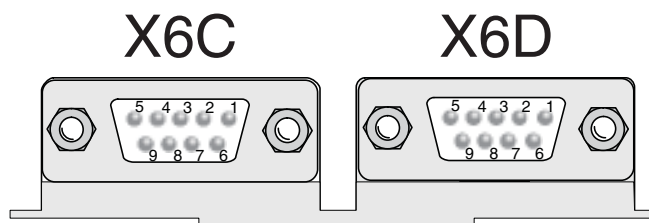

	X6C	X6D
Hardware	CAN RS 485	RS 232/485
Use	Bus Communications	Diagnostics
Pin	Signal	Signal
1	CAN V+	
2	CAN L	TxD, RS232
3	CAN H	RxD, RS232
4	RxD B +, RS485	RxD B +, RS485
5	RxD A -, RS485	RxD A -, RS485
6	CAN GND)	VP +5V (10mA)
7	Bus Ground	Bus Ground
8	TxD B +, RS485	TxD B +, RS485
9	TxD A -, RS485	TxD A -, RS485

4.2.1 LED Indicators

The LED indicators are available only on the Serial LCD Operator. The LEDs are used to indicate operational status. They can be used for troubleshooting and diagnostics. In addition, the function of the LED can be changed with parameters CH10 - 15.

	LED 1	LED 2
Off	No operation (noP) Drive not enabled	
● (Green)	Inverter running the motor	Run mode Drive is able to run
● (Orange)	-	Stop mode: Drive is being programmed or making calculations; FTP file transfer mode.
● (Red - Blinking)	A limit has been reached: Torque, Current, or Voltage (not yet implemented)	-
● (Red - Solid)		Drive is faulted

4.3 SD Card Hardware Version

The SD LCD operator accepts commercially available Secure Digital (SD) memory cards with FAT formatting.

The SD LCD operator is only available as v3.00.



- **FAT 16 formatting supports up to 2GB SD Card.**
- **FAT 32 formatting supports up to 8GB SD Card.**

Because the SD operator does not have a diagnostic port, it is not possible to connect to KEB Combivis software.



LCD Operator
Bottom View



Secure Digital (SD)
Memory Card

LCD Keypad

4.4 Backward Compatibility

Only the SD card operator will support KEB F5 control card V 4.2. v4.3 control card will be supported by the SD and Serial/CAN hardware versions. The F5 control card software version can be found in Diagnostics Screen #9.

v3.21 is not designed to be backward compatible with previous versions. If upgrading firmware versions, it would be necessary to reprogram the drive.

4.5 Menus and Navigation Overview

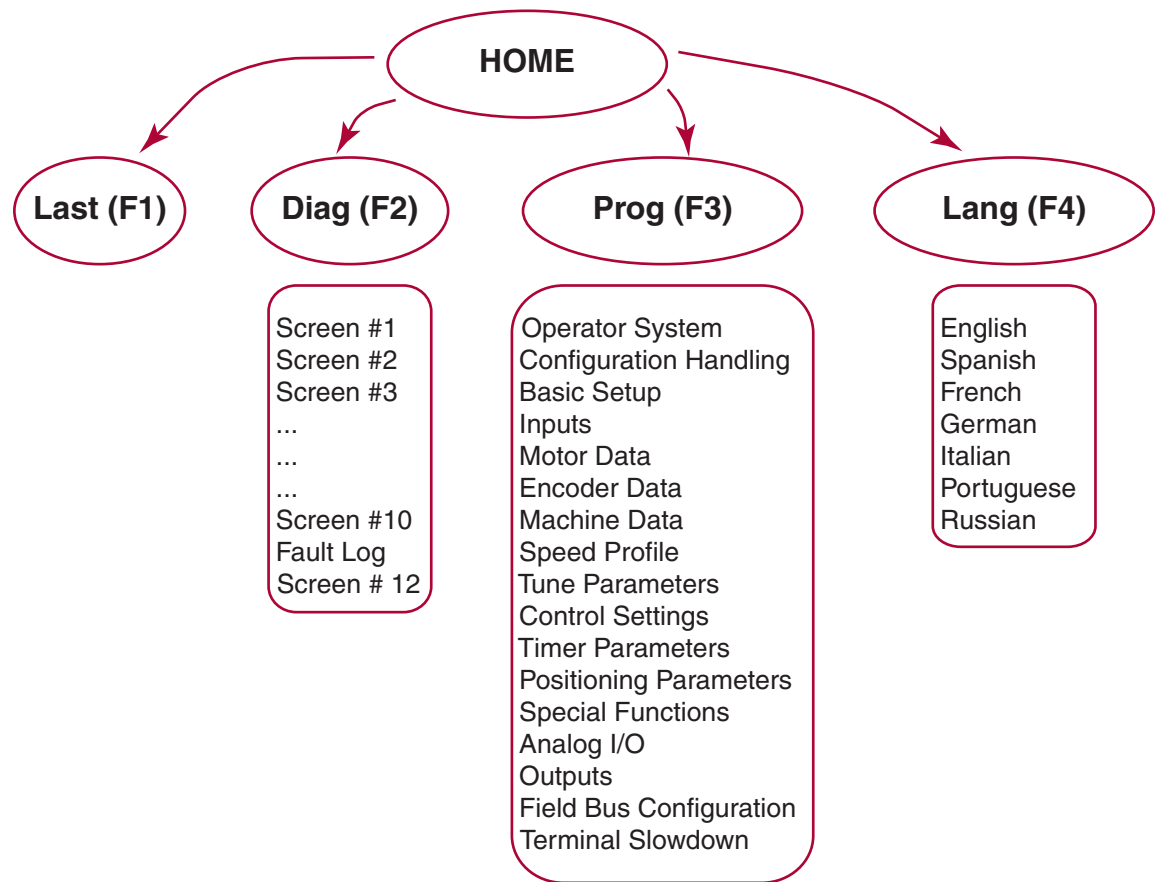

4.6 Home Screen

The home screen provides a split menu with basic diagnostics. The F2 hotkey accesses the diagnostic menus. The F3 hotkey accesses the programming menu. The F4 hotkey accesses the language settings.

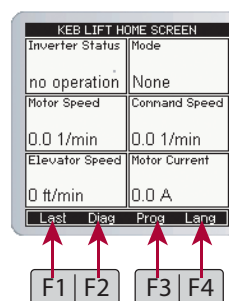

4.7 Languages

The LCD Keypad supports 7 different languages:

- English
- Spanish
- French
- Portuguese
- Italian
- German
- Russian

The language can be adjusted in several ways:

- During boot-up, if the operator & keypad are not synchronized, the user can access the language menu via the (F4) Hotkey

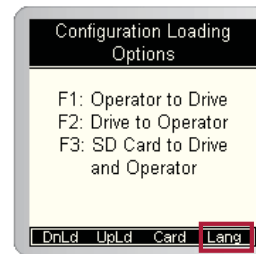

- At the Home screen, selecting the (F4) hotkey will take you directly to the language settings.
- Or the language settings can be accessed at *Home > Prog > Setup (F3) > Language*

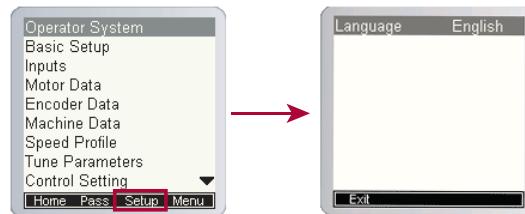

LCD Keypad

4.8 Programming Menu

The programming menu is where all manual parameter adjustment are made and can be accessed at *Home > Prog (F3)*.



The Parameter menu contains the following groups:

- Operator System (OS)
- Basic Setup (US)
- Inputs (LI)
- Motor Data (LM)
- Encoder Data (LE)
- Machine Data (LN)
- Speed Profile (LS)
- Tune Parameters (LL)
- Control Setting (LC)
- Timer Parameters (LT)
- Positioning Parameters (LP)
- Special Functions (LX)
- Configuration Handling (CH)
- Analog I/O (LA)
- Outputs (LO)
- Diagnostic Parameters (Dg)
- Field Bus Configuration (Fb)
- Terminal Slowdown (TS)

Complete parameter descriptions are listed in Section 6.



Not all parameter may be viewable and changeable, depending on the password accessibility. Refer to Section 4.8.2 for additional information on password access.

4.8.1 Parameter Adjustment

When adjusting a parameter, press “ENTER” to access *Edit Mode*. Parameters values can only be changed in *Edit Mode*.

- Up/Down - Can be used to increment or decrement the number. Press the ENTER key to save the change.

- F4 Hotkey (NUM) - Pressing the F4 key in *Edit Mode* allows a user to adjust each placeholder value. The other Hotkeys change the placeholder or add a decimal point. Press “ENTER” to save the changes.

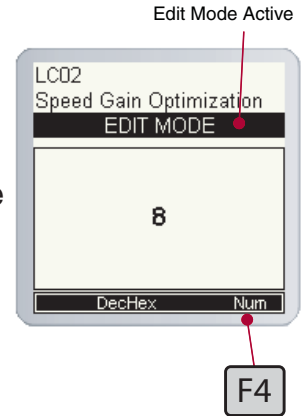

- >> : Used to move placeholder for adjustment.
- . : Inserts decimal point.
- <- : Used as a backspace to move placeholder for adjustment
- + - : Used to change the sign of the value.

An example of using the NUM function to change a parameter is shown below:

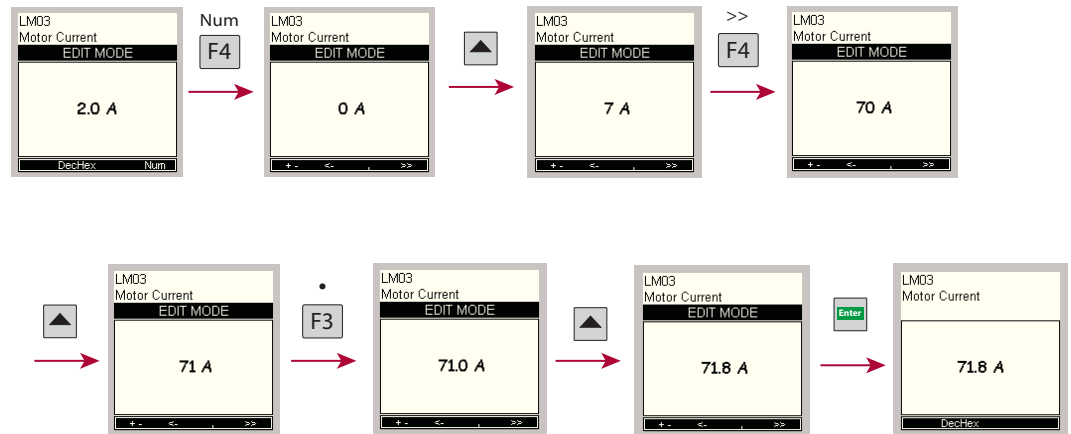

The NUM function can be useful for selecting parameter options from a list using its assigned value as opposed to scrolling through the text descriptions. Most parameters with a large list option will have a corresponding NUM column listed in the parameter description of the manual for quick and easy adjustment.

The NUM function can also be very quick and useful for adjusting large numbers as opposed to scrolling.

With parameters that allow multiple items to be selected together, the NUM value would correspond to the sum of the individual selections.

LCD Keypad

4.8.2 Setting the Password

The LCD keypad has different access levels that are password protected. Different levels provide access to more parameters and give the read and write privileges.

If you expect to see more parameters or need higher access to change parameters, please contact the control manufacturer.

A user can change the password by:

- Parameter OS01 at *Home > Prog > Operator System > OS01*
- *Home > Prog (F3) > Pass (F2)*

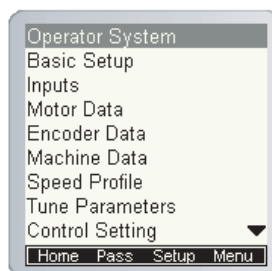

The following passwords are used to gain access levels:

User	Access Level	Password	Typical Access*
KEB	R/W		All background parameters
OEM	R/W	479	Control Type Motor Type Input/Output Functions
Adjuster	R/W	119	Advanced motor, speed, & control parameters
User	R/W	27	Basic Level with Write privileges
Basic	Read only	11	Diagnostics, Fault Logs



The password must be entered with the NUM method of adjustment described in Section 4.8.1.

From the OEM level, parameters can be hidden in the Adjust, User, and Basic access levels (ie. unused or OEM specific settings). Refer to Section 4.11 for additional information.

Temporary OEM Password Access

A unique, temporary password can be generated to provide OEM level access for a period of one day for troubleshooting purposes.

Using the program **Elevator Password Generator.exe**, enter the date set in the keypad operator. This can be changed at: Home > Prog > Setup > Date. The program will generate a unique password based on the date set in the keypad operator which will provide temporary OEM password access which is valid until the date in the keypad operator changes.

LCD Keypad

4.8.3 Units

The KEB LCD operator supports both imperial and metric units. Toggling between unit settings only scales the parameters and does not change any internal values.

The units can be changed at *Home > Prog > Basic Setup > US02*



The ability to change units is dictated by the user access level.

4.9 Diagnostics Screen

The LCD operator has split-view diagnostic screens. The diagnostics are grouped together which makes it easier to view several related parameters. The screens can be accessed at *Home > Diag*

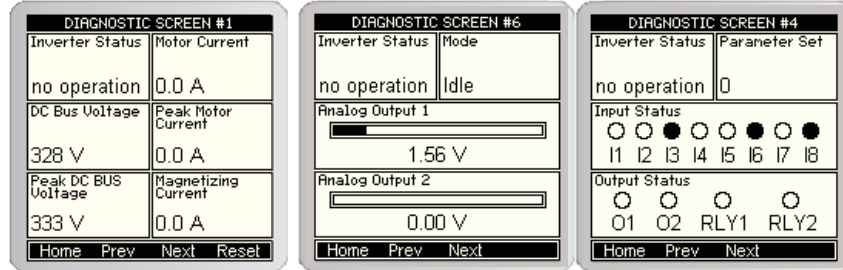

4.9.1 Error Messages & Fault Log

If a malfunction occurs during operation, the drive shuts down operation and the keypad will display an error. Error messages can be reset by pressing “RESET” F4 hotkey.



The LCD operator incorporates a real-time clock. This enables faults and special events to be recorded with a time-stamp in the Diagnostics Screen Log. To set the date and time, refer to Section 4.10. With the SD Card keypad operator hardware version, the clock stops when the keypad is not powered on. With Serial/CAN keypad operator hardware version, the clock continues even when not powered on.

The Diagnostics Screen Log can be accessed in the Diagnostics menu and is the last screen. To access: Home > Diag > Prev.

The Diagnostics Screen Log includes drive faults (Error Overcurrent, Overvoltage, Overload, Encoder, etc.), operation faults (eg. Drive Enable Dropped, Unintended Movement, Speed Following Error) Speed/Direction Selection Error, Analog Signal/Serial Speed Command Failure, Main Contact/ Brake Switch Failure, etc.), special operation modes (Emergency Slowdown, UPS Mode, etc.).

The EEPROM will automatically create and store a new .txt file in flash memory every 50 events.

For more information on inverter status/error messages see Section 7 - Diagnostics & Troubleshooting.

4.9.2 Fault Data Logging

The fault data logging function can be used to capture a scope trace of up to four parameters in high resolution before and after a drive fault is triggered. The scope file is then saved to flash memory on the keypad operator and the file can be transferred from the keypad operator via FTP and be imported within Combivis 6 to evaluate the scope trace.

The function is available under Prog > File > Fault Logging Menu.

Parameter Selection

Up to four parameters from the Diagnostics Parameters and/or Field Bus Configuration parameters can be selected for the scope trace. For each scope channel, select the channel number 1 - 4, then select either Diagnostics Parameters or Field Bus Configuration, then scroll through the corresponding parameter list to select the parameter for the corresponding channel.

Function Enabled/Disabled

Select whether the logging function is active.

Base Block Checking

The Base Block status indicates the output transistors have been safely shut off and are being blocked from further operation. It is not an error, but will appear before an error. Another typical occurrence would be if the drive enable is dropped while current is being output.

When Base Block Checking is off the scope is triggered only by a drive fault. When active, the scope trace will be triggered additionally by the base block status.

Sample Time

Select the sample time of the scope trace in 5ms resolution.

Trigger Value

Percentage of the scope trace that is recorded before the trigger occurs with the remaining after the trigger.

Last Fault Code

Indicates the last fault code. Refer to Section 6.16 Diagnostics Parameters DG02 for text description of numerical fault code.

4.10 Date & Time

The LCD keypad has a real-time clock and stores the date. This allows the operator to keep time stamps of faults and track total run hours.



The SD card operator only increments the time counter when the control card is powered. In the event of a power loss, the SD operator will store the last time/date stamp and continue counting when power is restored.

The Serial/CAN operator does keep track of the time/date and will do so for several weeks without power.

4.10.1 Setting the date

The date can be initialized by going at *Home > Setup > Date*. Press enter to enter to edit the parameter and enter to save the changes.

The date format is mm/dd/yyyy.

4.10.2 Setting the time

The time can be initialized at *Home > Setup > Time*. Press enter to enter to edit the parameter and enter to save the changes.

The time format is 24-hour.

LCD Keypad

4.11 Customizing Parameter Lists

Custom parameter lists can be made to mask off parameters from view, depending on user access password level.

The OEM password level provides read and write access to all applicable keypad operator parameter. A custom parameter list applies to all lower password levels, although whether a parameter is viewable or has write access also depends on each password level which has precedence over the custom parameter list. Minimum password access levels for parameters are listed in Section 8.1.

To create a custom parameter list, the syntax of the list to be created in a text files is:

XXXX Y

XXXX = Hex Address of keypad operator parameter

Y = 1 -> ON (viewable),

0 -> OFF

Keypad operator parameter hex addresses are listed in Section 8.1.

Only parameter addresses listed as ON will be made available from the custom parameter list.

A parameter address not listed is set as OFF.

Any information listed past Y is ignored.

Example:

LS01 Leveling Speed
Hex Address = 0881h
Password Level = Basic

LS02 High Speed
Hex Address = 0882h
Password Level = Basic

LC41 System Inertia
Hex Address = 0BA9h
Password Level = Adjuster

The list to be created:

0881 1
0882 0
0BA9 1

LC41 will be accessible regardless in the OEM password level.

LC41 will be accessible in the Adjust password level.

LC41 will not be accessible in the User or Basic password Levels

LS02 will be accessible in the OEM password level only.

LS01 will be accessible in all password levels: OEM, Adjuster, User, Basic.
LS01 will read-only in the Basic password level

Once the text file for a custom parameter list has been created, it must be saved as the following: **para_dis.txt**.

The para_dis.txt file must then be saved to the keypad operator flash memory. This can be done with either keypad hardware version, SD or Serial/CAN.

For the SD keypad operator, the text file must be saved to the SD card.
For the Serial/CAN keypad operator, the text file must be transferred via FTP.

To save the custom parameter list text file to flash, OEM password level is required. From the Programming Menu, the 'File' option (F4) will then be listed. Under the 'File' list, select 'File Operations.' Under 'File Operations' select either the 'Card' or 'FTP' option (F2), depending on whether the keypad operator hardware type is SD Card or Serial/CAN. When the text file has been transferred to the keypad operator flash memory, select 'Menu' (F1), then 'Prog' (F1) to return to the Programming Menu.

LCD Keypad

4.12 Customizing Defaults

A pre-saved parameter file can be used to create custom defaults settings.

The pre-saved parameter file can either be created using the Combivis computer program or taken as an upload from a drive already programmed. The file type needs to be **.dw5**.

The .dw5 file must then be saved to the keypad operator flash memory. This can be done with either keypad hardware version, SD or Serial/CAN.

For the SD keypad operator, the text file must be saved to the SD card. For the Serial/CAN keypad operator, the text file must be transferred via FTP.

To save the custom parameter list text file to flash, OEM password level is required. From the Programming Menu, the 'File' option (F4) will then be listed. Under the 'File' list, select 'File Operations'. Under 'File Operations' select either the 'Card' or 'FTP' option (F2), depending on whether the keypad operator hardware type is SD Card or Serial/CAN. When the .dw5 file has been transferred to the keypad operator flash memory, select 'Menu' (F1), then 'Prog' (F1) to return to the Programming Menu.

To load the .dw5 parameter file to the keypad operator, set CH03 Restore Parameters = Load Motor Data.

To save the current settings as the new defaults, set US05 = Create OEM Default.

To revert to the custom .defaults, set CH03 = Factory Reset or US05 = Restore OEM Defaults

5. Initial Start Up

5.1 Connecting the drive and operator

The drive and operator must be “synched” before being able to operate. When the operator/drive are initially booted up, the parameters of each are compared and it is determined if the units are synched. If not, the user will be prompted which parameters should be used.



A drive/operator will not be synched under the following conditions:

- **A default drive and/or operator is being installed**
- **The operator was used to program another drive**

5.1.1 Default Operator and Drive

If the drive and operator are default the user will be prompted to either copy preconfigured motor data to the drive and keypad operator or begin by manually programming:

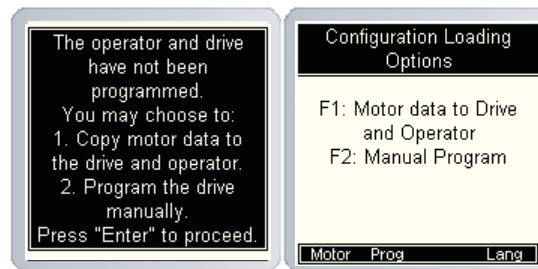

5.1.2 Previously programmed Operator or Drive

If either the drive or operator have been previously programmed, the user will be given the option to download from the keypad operator to the drive, upload from the drive to keypad operator or copy motor data to the drive and operator:

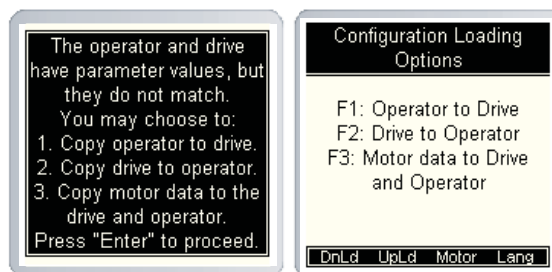

5.1.3 Copying Motor Data to Drive and Operator

If copying motor data to drive and operator, the user will be directed to CH05 Motor Type to select a particular model motor. Additional instructions are listed in Section 6.12.

Initial Startup

5.2 Manual Programming

This section serves as a quick guide to manually program a KEB Elevator drive from default. Please note that advanced functionality or settings might not be listed in this section.

For more information on specific parameters see section 6.0 - Parameter Descriptions

5.2.1 Getting Started

The KEB drive can be manually programmed in the programming menu at *Home > Prog (F3)*.



In order to manually program the LCD keypad, a user should begin at the top of the programming menu with “Basic Setup” and work their way downwards, filling in the required information. The OEM Password level must be set in order to make changes:

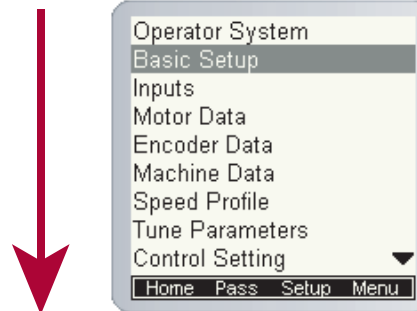

5.3 Basic Setup

The Basic Setup is where the initial programming must begin. Here, the application fundamentals are established prior to configuration.



Note: In most cases the elevator control manufacturer will make the adjustments in Basic Set-up but it is good to verify the correct settings.

The Basic Setup menu can be accessed by: *Home > Prog (F3) > Basic Setup*. All these parameters must be adjusted:

- US02 - System Units (Imperial/Metric)
- US03 - Motor Type (i.e. Induction geared or PM synch gearless)
- US04 - Control Type (i.e. Binary, Serial, Analog)

Next, the configuration must be loaded using US05. This step serves to load the KEB drive with the correct limits and internal settings according to the application:

- US05 - Load Configuration (**Write config. to drive**)

If loaded successfully, US05 should change from *Not configured* to *Configuration OK*, indicating the drive and operator are synched.



If the US04 Control Type or US02 System Units settings are changed after a configuration has been loaded, a new configuration must be written to the drive. Writing the new configuration will NOT default all previous settings.

If the US03 Motor Type must be changed after a configuration has been loaded, a new configuration must be written to the drive and writing the new configuration WILL default all previous settings.

Then, enter the contract speed of the application, this will set the speed safety limits internal to the drive:

- US06 - Contract Speed

SETUP OF THE BASIC INFO IS NOW COMPLETE!

5.4 Inputs

Next, the inputs must be configured (*Home > Prog > Inputs*) and assigned functionality depending on the controller requirements.

- LI01 - Type of Input (PNP or NPN logic)
- LI04-11 - Input Function

SETUP OF THE INPUTS IS NOW COMPLETE!

Initial Startup

5.5 Motor Data

Next, the basic motor parameters must be entered before doing an automatic motor learn (*Home > Prog > Motor Data*).

The KEB F5 inverter is capable of driving either AC induction motors or AC permanent magnet motors. From here on, induction motors will be referred to as “IM” and permanent magnet motors will be referred to as “PM”.

5.5.1 Induction Motors

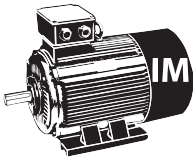

For induction motors, enter the following parameters from the nameplate:

- LM01 - Motor Power (note correct units)
- LM02 - Motor Speed (RPM - Make sure it is rated “slip speed”)
- LM03 - Motor Current
- LM04 - Motor Frequency
- LM05 - Motor Voltage
- LM06 - Motor Power Factor

5.5.2 Permanent Magnet Motors

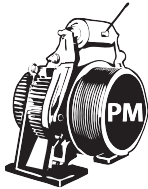

Further induction motor data parameters will be determined during the Motor Tune process, described later.

For PM motors, enter the following parameters from the nameplate:

- LM02 - Motor Speed (RPM)
- LM03 - Motor Current
- LM04 - Motor Frequency
- LM05 - Motor Voltage (EMF rms @ rated speed)
- LM07 - Motor Torque (note units)

For synchronous motors it is important that the relationship between the motor speed and rated frequency correlate to the number of poles. The # of poles should always be an even number. It is important to verify the following relationships!:

$$\text{Motor Speed (RPM)} = \frac{\text{Rated Motor Frequency (Hz)} * 120}{\text{\# of Motor Poles}}$$

$$\text{LM02} = \frac{\text{LM04} * 120}{\text{\# of Motor Poles}}$$

$$\text{LM04} = \frac{\text{LM02} * \text{\# of Motor Poles}}{120}$$

$$\text{\# of Motor Poles} = \frac{\text{Rated Motor Frequency (Hz)} * 120}{\text{Motor Speed (RPM)}}$$

Torque units will change depending on which units are set in US02. For reference, here are the equations to convert between Imperial and Metric units provided different nameplate information:

$$\text{lb-ft} = \frac{\text{Nm}}{1.355} = \frac{\text{HP} * 5252}{\text{Rated Motor Speed}} = \frac{\text{kW} * 7051}{\text{Rated Motor Speed}}$$

Further PM motor data parameters will be determined during the Motor Tune process, described later.

SETUP OF THE MOTOR DATA IS NOW COMPLETE!

5.6 Encoder Data

Next, the basic encoder parameters must be entered:

- LE02 - Encoder Pulse Number (ppr)

For absolute encoders, additional parameters may need to be adjusted.

SETUP OF THE ENCODER DATA IS NOW COMPLETE!

5.7 Machine Data

Next, the basic machine data must be entered. The machine data determines a scalar internal to the drive which translates a familiar linear speed (e.g. fpm) to a rotary speed (e.g. rpm) which the drive uses:



Note: Incorrect Machine Data would cause the elevator to run too fast or too slow.

The following data would need to be entered:

- LN01 - Sheave Diameter (note the units)
- LN02 - Gear Ratio (x:1)
- LN03 - Roping Ratio (x:1)

If the sheave diameter is not known, it can be measured with a tape measure. Some sheave manufactures will show “Minimum Groove Diameter” on a plate attached to the sheave. This is the diameter to the bottom of the groove, which is normally about one inch smaller than the actual diameter at which the rope lies. Therefore, when this dimension is provided, add one inch to it and enter that value in LN01.

For a gearless job, the Gear Ratio would be 1. If the gear ratio is unknown for a geared machine, LN05 will calculate an Estimated Gear Ratio from the motor rated speed, contract speed, roping ratio and sheave diameter. This value could then be entered as the gear ratio in LN02.

SETUP OF THE MACHINE DATA IS NOW COMPLETE!

5.8 Speed Profile

Next, the speed control parameters can be set for digital, binary, and positioning control.



The speed commands in Analog and Serial speed control are dictated by the controller, so these speed parameters will have no affect to the actual run speed, although a LS02 High Speed must be entered for Analog speed control to dictate the speed to which 10V corresponds.

Enter the following speed settings if applicable:

- LS01 Leveling Speed
- LS02 High Speed
- LS03 Inspection Speed
- LS04 Correction Speed
- LS05 Intermediate Speed 1
- LS06 Intermediate Speed 2
- LS07 Intermediate Speed 3



Note: The nomenclature of the speeds above are defined (as default) by KEB. Although, the controller manufacturer may assign speeds differently (e.g. the controller manufacture may use Intermediate Speed 1 for High Speed), it is suggested, however, that inspection and leveling speeds are assigned accordingly based on functionaiity and/or speed limits assigned to these speeds.

If the elevator does not move at the correct speed, verify which speed is selected and it's corresponding setting, as well as verify whether the command speed and encoder speed match.

5.8.1 Profile Adjustment

For digital, binary, and positioning control, the available profile adjustments are shown below (for analog and serial speed control the controller will dictate the profile and these settings can only be used to limit the rates).

The KEB LCD operator can approximate all relevant profile parameters depending on the aggressiveness of the application. A user can select either a soft, medium, or hard profile. The adjustments can be made with:

- LS15 - High Speed Profile
- LS16 - One Floor Profile (Intermediate Speeds 1, 2)
- LS17 - Emergency Profile (Intermediate Speed 3)

Alternatively, if a user wants to customize the profile, they can adjust the different speed profiles based on the selected speed:

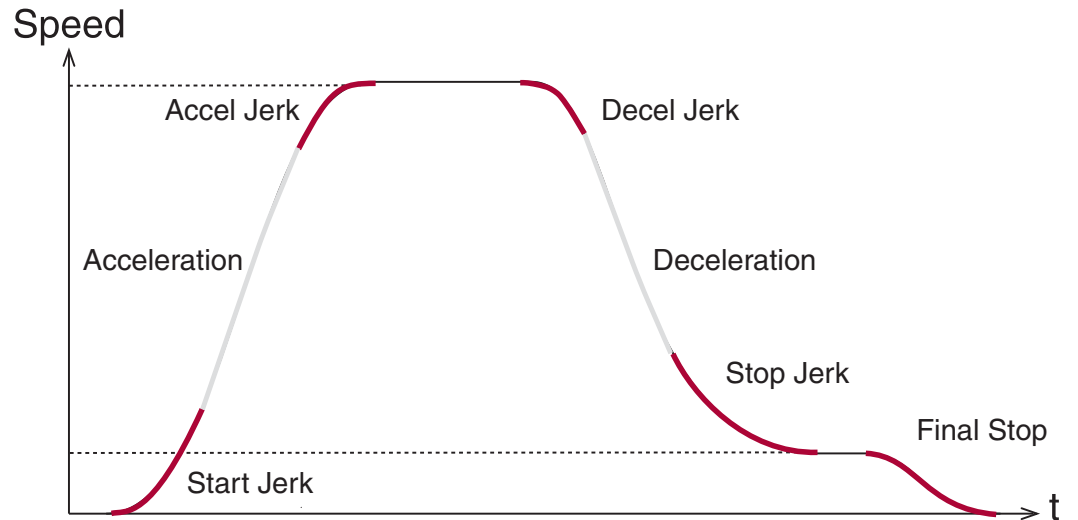

	High Speed	One Floor (Short Runs - Intermediate Speeds 1,2)	Inspection	Emergency (Intermediate Speed 3)
Acceleration	LS20	LS30	LS50	LS40
Start Jerk	LS21	LS31	LS51	LS41
Accel Jerk	LS22	LS32	LS52	LS42
Deceleration	LS23	LS33	LS53	LS43
Decel Jerk	LS24	LS34	LS54	LS44
Stop Jerk	LS25	LS35	LS55	LS45
Final Stop	LS43-45	LS43-45	LS43-45	LS43-45

SETUP OF THE SPEED PROFILES IS NOW COMPLETE!

Initial Startup

5.9 Motor Learn

Next, the complete motor data must be learned with the automated learn function.

The motor characteristics, including the motor's inductance and resistance, can be learned with the drive's tuning function. The Motor Learn function can be found under the Tune Parameters group from the Programming menu (*Home > Prog > Tune Parameters > LL01*). Begin the procedure by setting:

- Motor Tuning LL01 = Start



Note: It may be necessary to program the drive outputs accordingly for proper operation with the controller. Refer to Section 6.13 for setting the output functions.

Follow the instructions on the LCD screen. The user is instructed to:

1. Disable the brake
2. If the speed is generated by the controller (Analog or Serial), then set external speed command to zero
3. Press and hold inspection (speed + direction + enable inputs) until completed

The process should take 2-5 minutes and will emit a high pitched noise while the drive measures various motor parameters.



Re-establish proper brake operation wire and return the inspection speed if changed on the controller.

SETUP OF THE MOTOR LEARN IS NOW COMPLETE!

5.10 Encoder Learn

Next, the encoder needs to be initialized and configured.

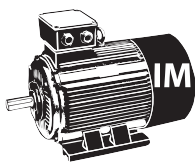

In applications with Induction Motors, the Encoder Synchronization function can be used to determine the correct A/B phasing of the encoder channels and whether the direction needs to be inverted for the correct direction of travel.

For IM motors, the Encoder Synchronization can be adjusted at parameter:

- Encoder Synchronization LL07 = Start

Proceed to section 5.10.3 (IM only)



When using PM motors, the encoder position/pole must also be learned. This step is unique to PM applications and does not need to be done with IM machines. Knowing the motor pole position relative to the encoder allows the KEB drive to apply the proper stator magnetic field commutation angle for maximum torque.



For absolute encoders on PM motors, if at any time the physical relation between the motor shaft and encoder changes (i.e. encoder replaced, encoder slippage, etc.) the encoder position must be relearned.

There are 2 functions available to determine the encoder pole position with PM machines:

1. Stationary Pole Identification (SPI) - The SPI process can learn the encoder position without movement (i.e. ropes on and brake set), but does not determine whether the A/B encoder channels must be swapped - this would be determined iteratively and is described later.
2. Encoder Pole Learn - This function will determine the encoder position but requires sheave movement with a relatively frictionless load (i.e. balanced car or unroped sheave). The benefit of this method is that proper A/B phasing can be determined automatically.

Initial Startup

5.10.1 SPI Encoder Learn

SPI can be done with the ropes on and the brake set. To start the SPI functionality go to LL05 and follow the instructions on the LCD:

- LL05 - SPI (“START”)

The user will be prompted to:

1. Disable the brake
2. If the speed is generated by the controller (Analog or Serial), then set external speed command to zero
3. Press and hold inspection (speed + direction + enable inputs) until finished

During the SPI process, the motor will make a series of chirps and the LCD display will show the encoder position samples. The encoder pole position found by SPI will be written to parameter LE06.

After the process has completed, the user will be prompted to complete the Encoder Synchronization procedure to establish the correct A/B encoder channel phasing and direction of rotation. Proceed to Section 5.10.3 for further details. If the Encoder Synchronization process has previously been completed, the user may Abort the Encoder Synchronization step without losing the learned Encoder Pole Position.



Re-establish proper brake operation wire and return the inspection speed if changed on the controller.

5.10.2 Encoder Pole Position Learn

As an alternative to using the SPI function, a user can use the Encoder Pole Position Learn. The advantage of the Encoder Pole Position Learn is that it learns the correct A/B channel phasing in addition to the pole position. However, the procedure does require frictionless movement (unroped sheave or balanced car).

To begin the process, set Encoder Position Pole Learn to “Start”:

- LL06 - Encoder Pole Position Learn = Start

The user will be prompted to:

1. Press and hold the inspection (speed + direction + enable inputs) until finished

During the process, the sheave will align to a motor pole and move back and forth a few degrees. During this time the encoder position will be shown on the keypad.

If the A/B phasing is incorrect the process will stop and notify the user. Then it will resume and automatically make the change and prompt the user to hold the inspection again.

When the process is complete, the keypad will prompt the user to release the inspection. The encoder position and A/B phasing information will be automatically written to parameters LL06 and LL03, respectively.

After the process has completed, the user will be prompted to complete the portion of the Encoder Synchronization procedure to establish the correct direction of rotation. Proceed to Section 5.10.3 for further details. If the Encoder Synchronization process has previously been completed, the user may Abort the Encoder Synchronization step without losing the learned Encoder Pole Position.

5.10.3 Encoder Synchronization

The Encoder Synchronization process will determine the correct A/B encoder channel phasing and direction of rotation for both IM and PM motors. For PM motors, the Encoder Synchronization process immediately follows either method of learning the encoder pole position. Begin the process by setting:

- LL07 - Encoder Synchronization to “Start”

Then follow the directions on the keypad. The drive will iteratively run the elevator and swap the phasing and direction of the A/B channels as needed.

SETUP OF THE ENCODER LEARN IS NOW COMPLETE!

Initial Startup

5.11 Running the Motor

At this point, the drive should be set up far enough to run reasonably well on inspection speed. At this point, the user should run the elevator in both the up/down directions, verifying that the current in both directions is reasonable. The current can be viewed from the Home or Diagnostics screens. For a balanced car, the current should be reasonably low. For an empty car, the running current should be less than motor rated current in both directions.

If operation on inspection speed in both directions shows no issues, the next step is to run the elevator up to high speed.

Before this is done, there may be a few parameters which need adjustment:

- LC30 - Maximum Torque (Default is 150%; Typically, normal values are 200-250%)



Note: Anytime any of the motor data parameters are adjusted, the LC30 Maximum Torque will automatically re-calculate to 150%.

5.11.1 Running at High Speed

Now, the elevator should be able to run at high speed with no major issues. At this point, if the user is satisfied, no further adjustments may be needed to increase ride quality since the default settings for the speed control provide a very good starting point in most cases.

5.12 Advanced Ride Adjustments

5.12.1 Inertia Learn

For optimum control of the elevator, it is recommended to learn the system inertia and activate the feed forward torque controller (FFTC).

FFTC reduces the dependence on the speed feedback from the motor by predicting what the system will do and providing the required torque command based on that prediction.

The first step in learning the system inertia is to get the car running at contract speed over multiple floors.

The next step is to balance the car and run on inspection in the middle of the hoist way and monitor the torque (Diag. screen #3). The motor torque in the up and down directions should be equal but in opposite direction. If this is not the case, adjust the counter weights before proceeding.

For buildings with 12 floors or less, run the car from bottom to top and top to bottom. For taller buildings, run between at least 10 floors in the middle of the hoist way (5 above and 5 below). This function will also take into account rope compensation or lack there of. So it is necessary to make this measurement in the middle of the hoist way.

When ready, run the car between floors at high speed. High speed must be reached! If it can't, then lower the speed such that the car reaches a stable speed for at least two seconds.

Begin the process by setting:

- LL10 - Inertia Learn to "Start"

Then follow the directions on the keypad. After each run, the user will have the option to calculate the inertia for that run. After four runs, the drive will automatically calculate the inertia based on the averages.



Note: During the Inertia Learn process, the drive reduces the acceleration to a fixed rate (1.5 ft/sec²). It may be necessary to adjust any speed following or tach error settings in the controller to prevent shutdowns.

5.12.2 Pretorque

The drive's internal pre-torque is a feature of the drive which can be used to minimize, if not totally eliminate, the rollback which may occur at brake pick, without the need for external load weighing devices. Pretorque is available when the LC01 Control Mode is set for Closed Loop FOC or Closed Loop Synthetic Pretorque.



Adjust the brake spring tension, brake voltage, and brake timing first. Note that it is often advantageous to use a lower spring tension and lower brake pick voltage to provide a softer lifting of the brake. This allows for a smoother transition from brake to motor. It should be noted that any subsequent changes to the brake could require readjustment of the pre-torque.

The pre-torque is active at the beginning of a run, according to the timer parameters LT02-03. When a run command has been given by the controller, the drive will first perform a brief phase current check of the motor before attempting to run. Upon successful completion it is safe to pick the brake and the LT02 Control Hold Off timer begins. During the LT02 Control Hold Off period, the speed gains are held low to prevent any disturbances under brake. After the LT02 Control Hold Off timer expires, the pre-torque period becomes active and the LT03 Speed Start Delay timer becomes active. The LT02 Control Hold Off timer should be set such that it expires briefly before the brake is picked so the pretorque period before the speed profile begins, LT03 Speed Start Delay, is active when rollback would occur.

During the pre-torque period, the corresponding speed gains for pretorque, LC05 KP Speed Pretorque and LC10 KI Speed Pretorque, are active; These can be adjusted as needed to reduce the amount of rollback. After the LT03 Speed Start Delay timer has expired, the pretorque period expires, the acceleration begins and the corresponding speed gains for acceleration and high speed are now active. For control modes which dictate the speed profile and when it begins (i.e. analog or serial) the pretorque period will expire as the acceleration begins.

Pre-torque Timing Chart

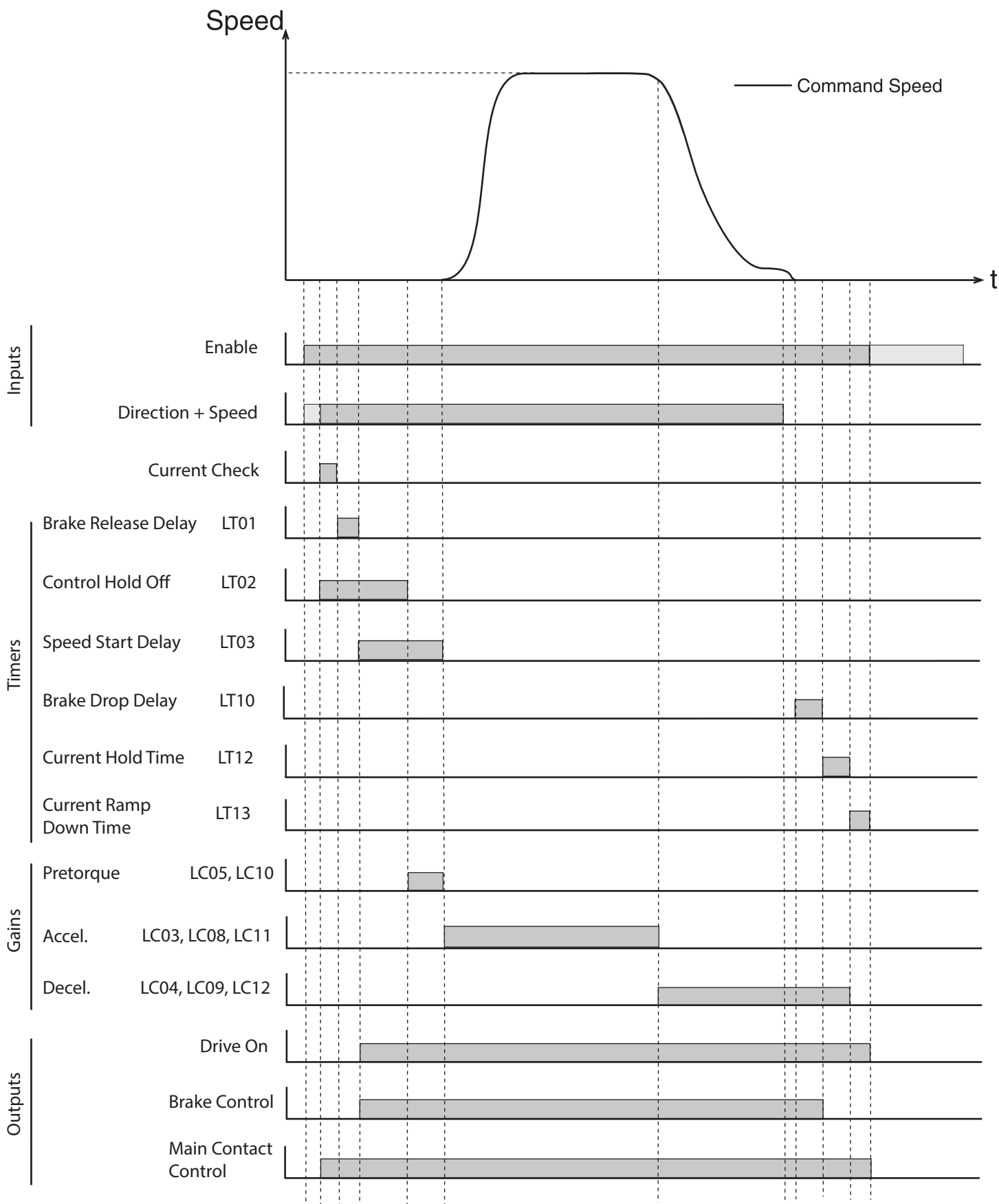

6.Parameter Description

The programming menu is where all manual parameter adjustment are made and can be accessed at *Home > Prog (F3)*.

The Parameter menu contains the following groups:

Operator System: OS00...OS25

These parameters provide general information about the operator and drive hardware and software. Additionally, the operator password level is set here which allows for different access levels.

Configuration Handling: CH01...CH15

These settings allow a user to save parameters and default to OEM settings.

Basic Setup: US02...US06

These parameters provide the very basic information needed to configure the drive, including: motor type, control type, and contract speed.

Inputs: LI01...LI20

These parameters define the logic of the inputs and assign control functionality to the digital inputs.

Motor Data: LM01...LM33

These parameters define and display all relevant motor values and motor protection settings.

Encoder Data: LE01...LE36

These parameters define the settings and scalings of the drive encoders

Machine Data: LN01...LN05

These parameters define the machine data, including: sheave diameter, roping ratio, and rated load values.

Speed Profile: LS01...LS55

These parameters adjust the speed, acceleration, and jerk values across the elevator run profile.

Tune Parameters: LL01...LL18

These parameters contain the automatic tuning parameters. Here you can the system inertia, motor data, and motor pole positions.

Control Setting: LC01...LC44

These parameters contain advanced adjustment parameters which affect the motor gains, system inertia gains, pre-torque, etc.

Timer Parameters: LT01...LT13

These parameters adjust brake and drive signaling timers.

Positioning Parameters: LP01...LP23

These parameters contain the adjustments needed for the drive positioning control.

Special Functions: LX01...LX20

These parameters allow advanced adjustment of the drive and facilitate function tests of drive components.

Analog I/O: LA01...LA40

These parameters define and adjust the analog inputs and outputs.

Outputs: LO01...LO32

These parameters define the functionality of the relay and solid-state drive outputs.

Diagnostic Parameters: Dg01...Dg62 (Combivis only)

These parameters define the functionality of the relay and solid-state drive outputs and are only viewable in Combivis, although most should be available in the Diagnostics Screens.

Field Bus Configuration: FB01...FB55

These parameters define the settings for control with serial communication data.

Terminal Slowdown: TS01...TS08

These parameters define the settings for NTSD inputs and speed thresholds.



Not all parameter may be viewable and changeable, depending on the password accessibility. Refer to Section 4.8.2 for additional information on password access.

US - Basic Setup Parameters

6.1 US - Basic Setup Parameters

US02

System Units

This parameter chooses to display the speed, accel, and torque units in either Imperial or Metric format.

Settings:	NUM
m / sec	0
ft / min	1
Default = ft / min	

US03

Motor Type

This parameter chooses the motor type and gearing configuration of the system.

Settings:	NUM
Induction Geared	0
Induction Gearless	1
PM synchronous Geared	2
PM synchronous Gearless	3
Default = Induction Geared	



Changing to a new configuration will return the parameter values to default! If a new configuration is loaded, a user will need to go through all start-up steps before running the motor.

US04

Control Type

This parameter selects the type of speed selection and rotation setting. Further details for each are provided on the following pages.

Setting:	Description:	NUM
Digital Speed Selection	Four digital inputs select up to five different speeds.	0
Binary Speed Selection	Three digital, binary-coded inputs select up to seven different speeds.	1
Absolute Analog Speed	0...10V = 0...Contract Speed Direction by digital inputs	2
Bi-polar Analog Speed	0...±10V = 0...±Contract Speed Direction by polarity, digital input for start	3
Serial Speed DIN66019, Service 49	Service 49 = 4x16-bit serial communication. Speed profile and control inputs via serial communication. Hardware enable required.	4
Serial Speed DIN66019, Service 50	Service 50=2x16-bit+1x32-bit+1x32-bit AUX R/W Speed profile and control via inputs serial communication. Hardware enable required.	5
Serial Binary Speed, DIN66019 Service 50	Service 50=2x16-bit+1x32-bit+1x32-bit AUX R/W Three software inputs select up to seven speeds. Hardware enable required.	6
Default = Binary Speed Selection (1)		



Digital inputs for speed and direction can be programmed to I1...I6, I8 with LI04-11, where I1>I2>...I8 for speed inputs

Digital inputs for direction can be programmed to I1...I6, I8 with LI04-11.

Logic tables for input-selected speed control are determined by LI03.

LI15 determines whether digital inputs and/or Control Word are used as direction signal for serial speed control modes.

See section 3.1 and 3.2 for the appropriate control terminal layout.

See Control Sequence part of this section for signal sequencing.

US - Basic Setup Parameters

Digital Speed Selection

Digital Speed Selection utilizes four digital inputs assigned in LI04-11 as Speed Selection (27) to select up to five speeds. Input priority will be I1>I2>...I8. The input logic table can be defined in LI03 Speed Input Decoding as to which corresponding speed in the LS parameter group is selected.

The speed profile between selected speeds will be internally generated by the drive according to the programmed acceleration, deceleration and jerk rates in the LS parameters group.

The direction is determined by digital inputs assigned in LI04-11 as Up (25) and Down (26). Both direction signals cannot be signaled simultaneously at the beginning of a run, otherwise 'Direction Selection Failure' will occur.

Binary Speed Selection

Binary Speed Selection utilizes three digital inputs assigned in LI04-11 as Speed Selection (27) to select up to seven speeds. Input priority will be I1>I2>...I8. The input logic table can be defined in LI03 Speed Input Decoding as to which corresponding speed in the LS parameter group is selected.

The speed profile between selected speeds will be internally generated by the drive according to the programmed acceleration, deceleration and jerk rates in the LS parameters group.

The direction is determined by digital inputs assigned in LI04-11 as Up (25) and Down (26). Both direction signals cannot be signaled simultaneously at the beginning of a run, otherwise 'Direction Selection Failure' will occur.

Absolute Analog Speed

A uni-polar 0...+10VDC analog signal connected to terminals AN1+ and AN1- controls the speed from 0...High Speed. The High Speed must be set in LS02. For controllers which do not output 10V corresponding to High Speed, the analog input can be scaled by LA05 AnIn1 Gain.

The speed profile acceleration, deceleration and jerk rates are externally generated by the controller. It is possible to limit external profile rates by setting LS15 = Internal Profile (4) and adjusting the according LS20-25 High Speed profile rates.

The direction is determined by digital inputs assigned in LI04-11 as Up (25) and Down (26). Both direction signals cannot be signaled simultaneously at the beginning of a run, otherwise 'Direction Selection Failure' will occur.

Bi-polar Analog Speed

A bi-polar, 0... ±10V analog signal connected to the terminals AN1+ and AN1- controls the speed from 0...±High Speed. The High Speed must be set in LS02. For controllers which do not output 10V corresponding to High Speed, the analog input can be scaled by LA05 AnIn1 Gain.

The speed profile acceleration, deceleration and jerk rates are externally generated by the controller. It is possible to limit external profile rates by setting LS15 = Internal Profile (4) and adjusting the according LS20-25 High Speed profile rates.

The direction is determined by the polarity of the analog signal, although a direction input is needed to control the start and stop routines. A digital input must be assigned in LI04-11 as Up (25) or Down (26). Either or both Up and Down inputs can be assigned but the direction selected does not matter since the actual direction is determined by polarity of the analog signal. If both directions are assigned as inputs, they cannot be signaled simultaneously at the beginning of a run, otherwise 'Direction Selection Failure' will occur.

US - Basic Setup Parameters

Serial Speed DIN66019, Service 49

RS485 serial communication DIN66019, Service 49 protocol includes 4x16-bit Process Data Inputs. The Process Data Inputs are then mapped to the corresponding functions: Field Bus Speed, Control Word, Pretorque, Position.

The serial communication connected to the keypad operator terminal port X6C controls the speed via the Process Data Input assigned as Field Bus Speed. The High Speed must be set in LS02.

The speed profile acceleration, deceleration and jerk rates are externally generated by the controller. It is possible to limit external profile rates by setting LS15 = Internal Profile (4) and adjusting the according LS20-25 High Speed profile rates.

The direction is determined by the sign of the Field Bus Speed, although a direction is needed to control the start and stop routines. Either a hardware or software direction input can be utilized. Either or both Up and Down inputs can be used for direction but the direction selected does not matter since the actual direction is determined sign of the Field Bus Speed. Software directions can be controlled via direction bits in the Process Data Input assigned as Control Word or assigned to software inputs Fb21-27 as Up (25) or Down (26) Direction and controlled via the Control Word. Hardware digital inputs can be assigned in LI04-11 as Up (25) or Down (26). If both software Control Word direction and hardware direction inputs are used, LI15 Direction Selection Inputs determines whether they are OR (0: Up and Down Inputs) or AND (2: Up & Down AND Serial Control Word) activated; if a software input is assigned as direction (as opposed to the Control Word direction bits), the hardware and software inputs are OR activated. If both hardware and software direction inputs are used, the selected direction must match. If both Up and Down directions are used, they cannot be signaled simultaneously at the beginning of a run, otherwise 'Direction Selection Failure' will occur.

The Drive Enable is AND activated by the Control Word and hardware input I7.



Refer to Section 6.15 for additional information regarding Field Bus parameters and serial communication.

Serial Speed DIN66019, Service 50

RS485 serial communication DIN66019, Service 50 protocol includes 1x32-bit, 2x16-bit Process Data Inputs and an 1x32-bit AUX R/W. The Process Data Inputs are then mapped to the corresponding functions: Field Bus Speed, Control Word, Pretorque, Position.

The serial communication connected to the keypad operator terminal port X6C controls the speed via the Process Data Input assigned as Field Bus Speed. The High Speed must be set in LS02.

The speed profile acceleration, deceleration and jerk rates are externally generated by the controller. It is possible to limit external profile rates by setting LS15 = Internal Profile (4) and adjusting the according LS20-25 High Speed profile rates.

The direction is determined by the sign of the Field Bus Speed, although a direction is needed to control the start and stop routines. Either a hardware or software direction input can be utilized. Either or both Up and Down inputs can be used for direction but the direction selected does not matter since the actual direction is determined sign of the Field Bus Speed. Software directions can be controlled via direction bits in the Process Data Input assigned as Control Word or assigned to software inputs Fb21-27 as Up (25) or Down (26) Direction and controlled via the Control Word. Hardware digital inputs can be assigned in LI04-11 as Up (25) or Down (26). If both software Control Word direction and hardware direction inputs are used, LI15 Direction Selection Inputs determines whether they are OR (0: Up and Down Inputs) or AND (2: Up & Down AND Serial Control Word) activated; if a software input is assigned as direction (as opposed to the Control Word direction bits), the hardware and software inputs are OR activated. If both hardware and software direction inputs are used, the selected direction must match. If both Up and Down directions are used, they cannot be signaled simultaneously at the beginning of a run, otherwise 'Direction Selection Failure' will occur.

The Drive Enable is AND activated by the Control Word and hardware input I7.



Refer to Section 6.15 for additional information regarding Field Bus parameters and serial communication.

Serial Binary Speed DIN66019, Service 50

RS485 serial communication DIN66019, Service 50 protocol includes 1x32-bit, 2x16-bit Process Data Inputs and an 1x32-bit AUX R/W. The Process Data Inputs are then mapped to the corresponding functions: Field Bus Speed, Control Word, Pretorque, Position. The serial communication is connected to the keypad operator terminal port X6C.

Serial Binary Speed selection utilizes three software inputs assigned in Fb21-27 as Speed Selection (27) to select up to seven speeds. Input priority will be Fb21>Fb22>...Fb27 (eg. I1>I2>...>I4). The input logic table can be defined in LI03 Speed Input Decoding as to which corresponding speed in the LS parameter group is selected.

The speed profile between selected speeds will be internally generated by the drive according to the programmed acceleration, deceleration and jerk rates in the LS parameters group.

The direction is determined by the selected direction. Either a hardware or software direction input can be utilized. Software directions can be controlled via direction bits in the Process Data Input assigned as Control Word or assigned to software inputs Fb21-27 as Up (25) and Down (26) Direction and controlled via the Control Word. Hardware digital inputs can be assigned in LI04-11 as Up (25) or Down (26). If both software Control Word direction and hardware direction inputs are used, LI15 Direction Selection Inputs determines whether they are OR (0: Up and Down Inputs) or AND (2: Up & Down AND Serial Control Word) activated; if a software input is assigned as direction (as opposed to the Control Word direction bits), the hardware and software inputs are OR activated. Both direction signals cannot be signaled simultaneously at the beginning of a run, otherwise 'Direction Selection Failure' will occur.

The Drive Enable is AND activated by the Control Word and hardware input I7.



Refer to Section 6.15 for additional information regarding Field Bus parameters and serial communication.

Control Sequence

Starting:

Drive Enable input, I7.

Up or Down direction.

May be given with the Drive Enable, before, or after.

If both the Up and Down directions are given, a Direction Selection Failure will occur.

If LI15 = Down Input Only, the Up direction is automatically selected internally.

Drive performs a current check.

The check requires about 300ms.

If the check does not pass, Error Low Motor Current will occur.

After the check passes, the drive will begin to modulate and output current.

LT01 Brake Release Delay timer begins.

After LT01 Brake Release Delay timer expires.

The Drive On output will be active

The Brake Control output will be active

LT03 Speed Start Delay timer begins

Speed Selection Error event will occur if a speed input is not received within $t = \text{LT01 Brake Release Delay} + \text{LT03 Speed Start Delay}$

LT02 Control Hold Off timer begins.

After LT02 Control Hold Off timer expires, LC05 and LC10 pretorque speed control gains are active.

US - Basic Setup Parameters

Speed Input(s), Analog or Serial pattern

May be given with the direction input, before, or after.

Acceleration to selected speed will begin after LT01 Brake Release Delay and LT03 Speed Start Delay

For external profile pattern from Analog or Serial speed control, LT03 Speed Start Delay will expire automatically when command becomes non-zero.

Pretorque stage is exited and the acceleration/run speed stage begins; LC03, LC08, and LC11 speed control gains are active

After an initial speed is selected, any higher speed selected will be ignored until zero speed is selected.

Stopping:

When a speed less than the run speed is selected (eg. leveling), the acceleration/run speed stage is exited and the deceleration/leveling stage begins; LC04, LC09, and LC12 speed control gains are active.

If all speed inputs or direction are dropped deceleration to zero speed will begin.

When zero speed command is reached and direction is dropped, the LT10 Brake Drop Delay timer begins. After the timer expires:

The Brake Control output is deactivated.

The LT12 Current Hold Time begins. After the timer expires:

The Drive On output deactivates.

The LT13 Current Ramp Down Time begins. After the timer expires:

The output current will have reached zero and the modulation will be turned off. The Drive Enable, I7, can be dropped.

Dropping the Drive Enable before the LT12 + LT13 timers have expired and the current has ramped down to zero will shut off the output current and modulation immediately, which may cause an abnormal stopping sensation.

Dropping the Drive Enable while outputting current will generate a Drive Enable Dropped Event.

US05

Load Configuration

After entering the basic setup parameters (US02-US04 & US06) the system configuration must be written to the drive. This procedure loads the drive with the correct parameters depending on the motor type and sets the correct limits and scalings.

Upon successful loading, US05 will display *Configuration OK*.

A user can also save/load OEM defaults and read/write to various memory locations. These are the following options available in US05:

Settings:	NUM
Not Configured	0
Configuration OK	1
Write Configuration to Drive	2
Read Configuration from Drive	3
Write Configuration to Flash	4
Read Configuration to Flash	5
Write Configuration to SD card	6
Read Configuration from SD Card	7
Create OEM Default	8
Restore OEM Defaults	9
Restore KEB Defaults	10

If the parameters US02 System Units, US03 Motor Type, or US04 Control Type are changed, the configuration will need to be reloaded in US05 for changes to take effect.



If the US03 Motor Type is changed, then a subsequent *Write Configuration to Drive* will result in the defaulting of drive parameters.

US06

Contract Speed

This parameter sets the contract speed which serves as an upper speed limit for normal operation.



In addition, an overspeed level is automatically set at 110% of this value.

LI - Input Parameters

6.2 LI - Input Parameters

LI01

Type of Input

Determines whether the digital inputs are PNP (sourcing, +24VDC = ON) or NPN (sinking, 0VDC = ON). This setting is applied globally to all inputs.

Settings:	NUM
PNP	0
NPN	1
Default = PNP (0)	

LI02

Digital Input Filter

This parameter controls a digital noise filter which can be used to mask relay bounce or other unwanted momentary signals. This filter applies to all digital inputs except the Drive Enable input (17). The drive enable input is processed immediately.

LI03

Speed Input Decoding

When the Control Type US04 is set as Digital (0) or Binary (1) Speed Selection, the logic table to which selected speed for a digital input combination must be determined.

Settings:	NUM
US04 = Binary Speed Selection	
B(Level - Correction - Inspection) + D(Level - Correct. - High - Inspect.)	0
B(Inspection - Level - Correction) + D(Level - Correct. - High - Inspect.)	1
B(Level - Correction - High) + D(Level - Correct. - High - Inspect.)	2
Decode with LI16 + D(Level - Correct. - High - Inspect.)	3
US04 = Digital Speed Selection	
B(Level - Correction - Inspection) + D(Level - Correct. - High - Inspect.)	0
B(Level - Correction - Inspection) + D(Level - High - Inspect. - Interm.)	4
B(Level - Correction - Inspection) + D(Inspect. - Level - High - Interm.)	8
B(Level - Correction - Inspection) + D(Level - Int.2 - High - Inspect.)	12
Default = B(Level - Correction - Inspection) + D(Level - Correct. - High - Inspect.)(0)	

B indicates US04 Control Type = Binary Speed Selection
D indicates US04 Control Type = Digital Speed Selection



Refer to US04 Control Type = Binary Speed Selection & Digital Speed Selection for description of the basic operation.

The LI03 setting only changes the logic table according to the corresponding US04 Control Type setting.

Digital Speed Selection

Utilizes four inputs to select up to five different speeds.

Older KEB elevator software and worldwide variants are available. Because of this, several different truth tables for the Digital Speed Selection are available:

Version:	LI03 Setting:	NUM
US Lift	D(Level - Correct. - High - Inspect.)	0
KEB (DE)	D(Level - High - Inspect. - Interm.) [Level at Start]	4
SFKEB	D(Inspect. - Level - High - Interm.)	8
-	D(Level - Int.2 - High - Inspect.)	12

The following are the corresponding logic tables. Although inputs I1...I4 are shown, the inputs actually used for speed selection are configurable and can be defined in LI04-11. Refer to Section 3.1.1 or 3.2.2 for input terminal assignments.

LI03 = D(Level - Correct. - High - Inspect), NUM = 0

US04	Digital Speed Selection	Param.	Control Inputs			
			I1	I2	I3	I4
	S ZERO	-	0	0	0	0
	S LEVELING	LS01	1	0	x	x
	S HIGH SPEED	LS02	0	0	1	x
	S INSPECTION	LS03	0	0	0	1
	S CORRECTION	LS04	0	1	x	x
	S INTERMEDIATE 1	LS05	1	1	0	x

Symbol:

1	=	Input is active
0	=	Input is not active
x	=	Setting has no effect or doesn't care

LI - Input Parameters

LI03 = D(Level - High - Inspect. - Interm.) [Leveling at start], NUM = 4

US04	Digital Speed Selection	Param.	Control Inputs			
			I1	I2	I3	I4
	S _{ZERO}	-	0	0	0	0
	S _{LEVELING}	LS01	1	0	x	x
	S _{HIGH SPEED} *	LS02	1	1	x	x
	S _{HIGH SPEED}	LS02	0	1	x	x
	S _{INSPECTION}	LS03	0	0	1	x
	S _{INTERMEDIATE 1}	LS05	0	0	0	1



* Valid only at start (once leveling speed is reached it is not possible to accelerate up to high speed again until after zero speed has been selected)

LI03 = D(Inspect. - Level - High - Interm.), NUM = 8

US04	Digital Speed Selection	Param.	Control Inputs			
			I1	I2	I3	I4
	S _{ZERO}	-	0	0	0	0
	S _{LEVELING}	LS01	0	1	x	x
	S _{HIGH SPEED}	LS02	0	0	1	x
	S _{INSPECTION}	LS03	1	x	x	x
	S _{INTERMEDIATE 1}	LS05	0	0	0	1

LI03 = D(Level - Int.2 - High - Inspect), NUM = 12

US04	Digital Speed Selection	Param.	Control Inputs			
			I1	I2	I3	I4
	S _{ZERO}	-	0	0	0	0
	S _{LEVELING}	LS01	1	0	x	x
	S _{HIGH SPEED}	LS02	0	0	1	x
	S _{INSPECTION}	LS03	0	0	0	1
	S _{INTERMEDIATE 1}	LS05	1	1	0	x
	S _{INTERMEDIATE 2}	LS06	0	1	x	x

Symbol: 1 = Input is active
 0 = Input is not active
 x = Setting has no effect or doesn't care

Binary Speed Selection

Utilizes three binary-coded inputs for up to 7 speeds.

Older KEB elevator software and worldwide variants are available. Because of this, several different truth tables for the Binary Speed selection are available:

	Versions:	LI03 Setting:	NUM
US Lift	1.60, 1.62, 1.72	B(Level - Correction - Inspection)	0
US Lift	1.51, 1.61, 1.71	B(Inspection - Level - Correction)	1
Euro Lift	1.00, 2.20	B(Level - Correction - High)	2
-	-	LI16 Custom Input Decoding	3

The following are the corresponding logic tables. Although inputs I2...I4 are shown, the inputs actually used for speed selection are configurable and can be defined in LI04-11. Refer to Section 3.1.1 or 3.2.2 for input terminal assignments.



Custom binary table selections can be created with LI16 Custom Input Decoding.

LI03 = B(Level - Correction - Inspection), NUM = 0

US04	Binary Speed Selection	Parameter	Control Inputs		
			I2	I3	I4
	S _{ZERO}	-	x	x	x
	S _{LEVELING}	LS01	1	0	0
	S _{HIGH}	LS02	0	0	1
	S _{INSPECTION}	LS03	1	1	0
	S _{CORRECTION}	LS04	0	1	0
	S _{INTERMEDIATE 1}	LS05	1	0	1
	S _{INTERMEDIATE 2}	LS06	0	1	1
	S _{INTERMEDIATE 3}	LS07	1	1	1

Symbol: 1 = Input is active
 0 = Input is not active
 x = Setting has no effect or doesn't care

LI - Input Parameters

LI03 = B(Inspection - Level - Correction), NUM = 1

US04	Binary Speed Selection	Parameter	Control Inputs		
			I2	I3	I4
	S ZERO	-	0	0	0
	S LEVELING	LS01	0	1	0
	S HIGH	LS02	0	0	1
	S INSPECTION	LS03	1	0	0
	S CORRECTION	LS04	1	1	0
	S INTERMEDIATE 1	LS05	1	0	1
	S INTERMEDIATE 2	LS06	0	1	1
	S INTERMEDIATE 3	LS07	1	1	1

LI03 = B(Level - Correction - High), NUM = 2

US04	Binary Speed Selection	Parameter	Control Inputs		
			I2	I3	I4
	S ZERO	-	0	0	0
	S LEVELING	LS01	1	0	0
	S HIGH	LS02	1	1	0
	S INSPECTION	LS03	0	0	1
	S CORRECTION	LS04	0	1	0
	S INTERMEDIATE 1	LS05	1	0	1
	S INTERMEDIATE 2	LS06	0	1	1
	S INTERMEDIATE 3	LS07	1	1	1

LI03 = Decode with LI16

Refer to LI16 Custom Input Decoding for details.

LI04

Input 1 corresponds to digital control terminal I1, X2A.10.

Input 1 Function

If this input is available, then it is free to be programmed with the one of the following input functions:

Programmable Input Functions for LI04 - LI11:	Description of Functionality:	NUM
No Function	No function is assigned to input	0
UPS Operation* **	The undervoltage limit is reduced and single phase detection is turned off to allow for supply from 230V UPS battery power source; the LS10 Battery Operation Speed is selected. Additionally, carrier frequency is dropped to 2kHz to reduce switching losses at very low output frequencies.	1
Reduced Torque*	The torque limit is set according to the LC31 Reduced Maximum Torque.	2
Emergency Profile*	Emergency Profile rate settings are loaded, according to parameters LS40-45	4
Emergency Generator Speed*	LS09 Emergency Power Speed is selected and all speeds are limited to this value	8
Fault Reset	Input to reset drive fault errors	16
External Fault	Input triggers specific 'External Fault' error. The source of the input may be from the controller, linked from a drive output, etc.	17
Brake Release Confirmation**	Indicates the drive has received brake open confirmation from brake microswitch. Prevents brake drag. Drive fault if no confirmation received. Refer to LI20 Brake Switch Function for reset options.	18
Main Contactor Check**	Indicates the Motor Contactor auxiliary has closed/opened. Qualifies enable. Drive will not output current until this confirmation has been received; fault if not. Premature open will result in drive disable.	19
Earthquake Speed	Earthquake speed selected, LS08. All speeds limited to 150fpm max.	20
Emergency Slowdown (ESD)**	Alternate slowdown selected, according to LS.48, 49; (e.g. quick stop).	21
Position Selection	Activates Positioning run (not yet implemented)	22
Position Deviation Reset	Corrects position deviation at leveling zone marker, according to distance set in LP05.	23
Teach Value	Learns floor value (not yet implemented)	24

LI - Input Parameters

Programmable Input Functions for LI04 - LI11:	Description of Functionality:	NUM
Up Direction	Input assigned as up direction command	25
Down Direction	Input assigned as down direction command	26
Speed Selection**	Input assigned for speed selection when US04 = Binary or Digital Speed Selection; I1 > I2 ... > I8.	27
ETS (Emergency Terminal Slowdown)**	Emergency Terminal Slowdown	28
NTS1 (Normal Terminal Slowdown)**	Normal Terminal Slowdown 1	29
NTS2 (Normal Terminal Slowdown)**	Normal Terminal Slowdown 2	30
NTS3 (Normal Terminal Slowdown)**	Normal Terminal Slowdown 3	31
Inspection Speed	Signaling the inspection speed input during a run can be used with serial and analog speed control types to indicate an inspection run and prevent from triggering 'Unintended Movement' faults or 'Drive Enable Dropped' events since the controller may dropped all inputs (enable, direction, speed) and brake at the same time during inspection runs. During inspection runs, the input must be held high until the drive returns the the Mode = Idle (nOP) status. In addition, an inspection run limits maximum speed command to 150 ft/min.	32
Default (LI04-11) = No Function (0)		

* Can be selected in combination (e.g. UPS + Reduced Torque + Emergency Profile)

** Additional information



Note: Two inputs cannot be assigned the same function, except Brake Release Confirmation.

Brake Release Confirmation

When an input is programmed for Brake Release Confirmation (18), the drive checks to see if the brake opens or closes within a set amount of time, otherwise a Brake Switch Failure fault will occur.

The timers are defined as:

Starting:

$$\begin{aligned} t &= LT01 + LT03 + 2.5 \\ &= \text{Brake Release Delay} + \text{Speed Start Delay} + 2.5s \end{aligned}$$

$$\text{Default} = 0.05s + 0.70s + 2.5s = 3.25s$$

Stopping:

$$\begin{aligned} t &= LT10 + LT12 \\ &= \text{Brake Drop Delay} + \text{Current Hold Time} \end{aligned}$$

$$\text{Default} = 0.10s + 0.50s = 0.60s$$

Two inputs can be programmed for the brake switch. During stop, the switches should be closed and open during run. If the brake switch is open during Mode = Idle, then the Brake Switch Failure fault will also occur. If during the run, the brake switch closes, the Brake Switch Failure fault will not occur.

LI - Input Parameters

UPS Operation

During UPS Operation there is the option for the drive to determine the direction of travel based on the load to utilize the least amount of power under a UPS supply.

To utilize this option, both direction inputs must be given for a run during UPS Operation mode. During the brake release sequence the drive will measure the motor torque and travel in the direction of least resistance. The conditions for determining direction of travel are:

- Less than Balanced = Up
- Greater than Balanced = Down

During UPS Operation mode, if a single direction input is given, the direction of travel will be normal, as directed.

During regular operation (not UPS mode), if both direction inputs are signaled simultaneously, a 'Direction Selection Failure' fault will occur.

Main Contactor Check (MCC) Input / Output

The MCC Input and Output can be incorporated independently or function in combination.

MCC Output

The MCC output is used to control the motor contactor. The MCC output is ON when the drive processes the Direction + Speed input commands (or direction only for analog and serial speed control modes). As the contactor closes, the Normally Open (NO) contact on the contactor should be used to signal the drive enable input.

The MCC output will turn OFF at the end of the run after the Direction input has been dropped AND the output current has ramped down to zero; the drive will be in Mode = No Direction (LS) at this point. As the contactor opens, the Normally Open (NO) contact on the contactor should be used to drop the drive enable input.

MCC Input

The MCC input function is used as a qualifier to the Enable input, indicating the motor contactor has closed. If used, the input must come from the Normally Closed (NC) auxiliary contact of the motor contactor; the Normally Open (NO) contact cannot be inverted for this function. The drive must see the contact is closed while the system is idle.

LI - Input Parameters

MCC Output + Input

When used in combination, the following diagram shows an example of the connection.

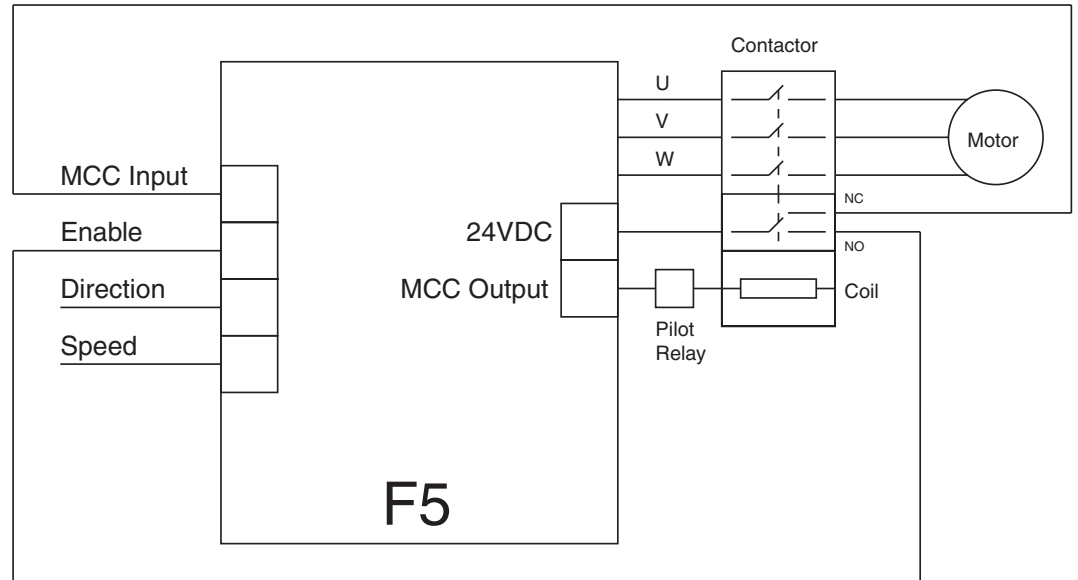

Speed Selection

When the US04 Control Type = Binary Speed Selection (1) or Digital Speed Selection (0), the X2A terminal strip inputs to be used for speed selection must be assigned with LI04-11. For Binary Speed Selection, three inputs will need to be assigned Speed Selection (27) and for Digital Speed Selection, four inputs will need to be assigned as Speed Selection.

For the inputs assigned as Speed Selection, the priority will be: I1>I2>...I8.

For example, the following would be an abbreviated logic table for US04 Control Type = Binary Speed Selection (1) with LI03 Special Input Function = B(Inspection - Level - Correction) (0) if LI05-07 (I2-I4) = Speed Selection and LI04 (I1) is set to another function other than Speed Selection.

	Parameter	Control Inputs			
		I1	I2	I3	I4
S LEVELING	LS01	x	1	0	0
S HIGH	LS02	x	0	0	1
S INSPECTION	LS03	x	1	1	0
S CORRECTION	LS04	x	0	1	0

Now, if LI04 were re-assigned such that I1 = Speed Selection, the table would be as follows (table shifts left toward input with priority):

	Parameter	Control Inputs			
		I1	I2	I3	I4
S LEVELING	LS01	1	0	0	x
S HIGH	LS02	0	0	1	x
S INSPECTION	LS03	1	1	0	x
S CORRECTION	LS04	0	1	0	x

Lastly, if LI05 (I2) were set to a function other than Speed Selection, then the previous table would change to the following (I2 splits table):

	Parameter	Control Inputs			
		I1	I2	I3	I4
S LEVELING	LS01	1	x	0	0
S HIGH	LS02	0	x	0	1
S INSPECTION	LS03	1	x	1	0
S CORRECTION	LS04	0	x	1	0

LI - Input Parameters

ESD - Emergency Slowdown

The Emergency Slowdown (ESD) can be used as an alternate slowdown profile, or quick stop.

The ESD input is an active low input controlled by the controller. 'ESD Input Failure' fault will occur if the ESD input is not detected (high) at the beginning of a run.

When the ESD input is dropped (pulse or constant), the drive will decelerate to the LS01 Leveling Speed using the dedicated ESD/ETS deceleration and jerk profile settings (LS48-49). The ESD profile generated by the drive will bypass any controller-generated serial or analog profile. The drive will then continue to run at the LS01 Leveling Speed until the hardware direction input is dropped. When the direction is dropped, the drive will decelerate to zero speed.

After the ESD has been signalled, the maximum speed will be limited to the LS01 Leveling Speed until the end of the run when the enable command is dropped.

The final stopping jerk when the direction is dropped at the end of the run will use the LS43-45 Emergency profile deceleration and jerk rates.

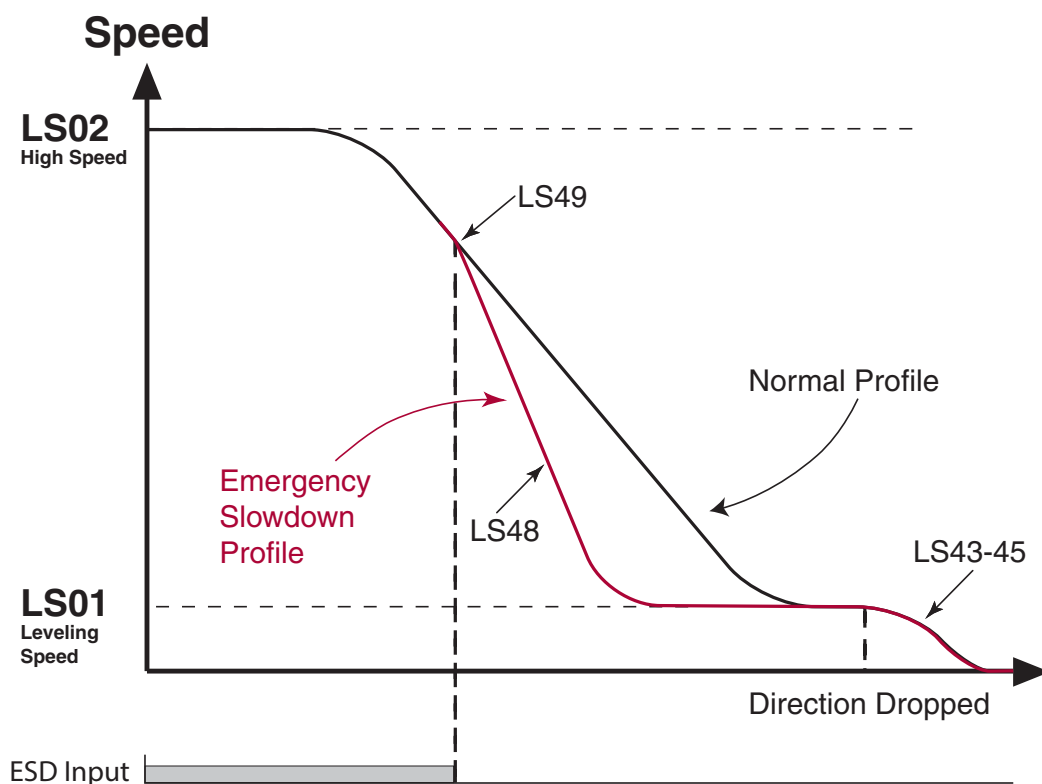

ETS - Emergency Terminal Slowdown

The Emergency Terminal Slowdown (ETS) can be used as an alternate slowdown profile, or quick stop.

The ETS input is an active low input controlled by the controller. 'ETS Input Failure' fault will occur if the ETS input is not detected (high) at the beginning of a run.

When the ETS input is dropped (pulse or constant), the drive will begin to compare the encoder speed against the LX19 ETS Speed threshold.

IF the encoder speed becomes GREATER than the corresponding LX19 ETS Speed threshold, then the drive will decelerate to the LS01 Leveling Speed using the dedicated LS48-49 ESD/ETS deceleration and jerk rates. The ETS profile generated by the drive will bypass any controller-generated serial or analog profile. The drive will then continue to run at the LS01 Leveling Speed until the hardware direction input is dropped. If the external (analog or serial) speed command is less than the LS01 Leveling Speed, the drive will follow the external command speed. When the direction is dropped, the drive will decelerate to zero speed.

ELSE, IF the encoder speed remains LESS than the corresponding LX19 ETS Speed threshold, the drive will continue as normal.

If an ETS slowdown has been initiated, the maximum speed will be limited to the LS01 Leveling Speed until the end of the run when the enable command is dropped.

The final stopping jerk when the direction is dropped at the end of the run will use the LS43-45 Emergency profile deceleration and jerk rates.

LI - Input Parameters

NTS - Normal Terminal Slowdown

The Normal Terminal Slowdown (NTS) can be used as an alternate slowdown profile, or quick stop.

The NTS input is an active low input controlled by the controller.

When the NTS input is dropped (pulse or constant), the drive will begin to compare the encoder speed against the corresponding NTSD threshold and direction (TS03-08).

IF the encoder speed becomes GREATER than the corresponding NTSD speed threshold (TS03-08), then the drive will decelerate to the TS02 NTSD Target Speed using the LS33-35 One Floor profile deceleration and jerk rates. The NTS profile generated by the drive will bypass any controller-generated serial or analog profile. The drive will then continue to run at the TS02 NTSD Target Speed until the hardware direction input is dropped. If the external (analog or serial) speed command is less than the TS02 NTSD Target Speed, the drive will follow the external command speed. When the direction is dropped, the drive will decelerate to zero speed.

ELSE, IF the encoder speed remains LESS than the corresponding NTSD speed threshold (TS03-08), the drive will continue as normal.

If an NTS slowdown is initiated, then the maximum speed will be limited to the TS02 NTSD Target Speed until the end of the run when the enable command is dropped.

The final stopping jerk when the direction is dropped at the end of the run will use the LS43-45 Emergency profile deceleration and jerk rates.

Refer to Section 6.17 Terminal Slowdown parameter group for additional information.

LI04-11: Digital Inputs

LI04...LI11 correspond to inputs I1...I8 (I7 reserved for Drive Enable). See Section 3.1.1 or 3.2.2 for terminal strip assignments. Each input is programmable with one of the input functions listed for LI04.

LI05

Input 2 Function

Input 2 corresponds to digital control terminal I2, X2A.11 (F5-A, Section 3.1.1).

LI06

Input 3 Function

Input 3 corresponds to digital control terminal I3, X2A.12 (F5-A, Section 3.1.1).

LI07

Input 4 Function

Input 4 corresponds to digital control terminal I4, X2A.13 (F5-A, Section 3.1.1).

LI08

Input 5 Function

Input 5 corresponds to digital control terminal I5, X2A.14 (F5-A, Section 3.1.1).

LI09

Input 6 Function

Input 6 corresponds to digital control terminal I6, X2A.15 (F5-A, Section 3.1.1).

LI11

Input 8 Function

Input 8 corresponds to digital control terminal I8, X2A.17 (F5-A, Section 3.1.1).

LI - Input Parameters

LI15

Direction Selection Inputs

Sets the function of inputs programmed as Up and Down according to US04 Control Type. In addition, the Brake Control output condition can be assigned to direction or speed inputs. Direction Selection and Brake Function options can be selected in combination.

Setting:	Description:	NUM
Direction Selection		
Up and Down Inputs	<p>When Up and Down functions are programmed to digital inputs (LI04-09), if either the digital input is selected OR the direction bit in the Control Word (serial speed control, Fb01), then the direction bit will be set.</p> <p>Up/Down inputs control direction or start. If both Up and Down are signaled, a 'Direction Selection Failure' fault will occur unless in UPS Operation mode; refer to LI04 UPS Operation for details*</p>	0
Down Input Only	<p>The Up direction is automatically selected internally when a speed input is given and the digital input for the down direction will have priority. When the speed input is dropped at the floor, the direction is internally dropped. The (LO05-20) output function Brake Control cannot be used with this selection.</p>	1
Up & Down AND Serial Control Word	<p>When Up and Down functions are programmed to digital inputs (LI04-09), the digital hardware input AND the Control Word (serial speed control, Fb01) direction bit must be set for the direction to be active. The hardware direction must match the software direction. If both Up and Down are signaled, a 'Direction Selection Failure' fault will occur.*</p> <p>Although the actual direction is determined by the signed serial speed command (Fb02), the sign must match the direction when utilizing LC01 with Synthetic Pretorque (5).</p>	2
Brake Function		
Function by Direction Inputs	<p>When an output (LO05-20) is programmed as 'Brake Control', the output will signal to set the brake when the direction input has dropped and the speed command has reached zero.</p>	0
Function by Speed Selection	<p>When an output (LO05-20) is programmed as 'Brake Control', the output will signal to set the brake when the speed input have all been dropped and the speed command has reached zero.</p>	4
Default = Up and Down Inputs + Function by Direction Inputs (0)		

LI16

Custom Input Decoding

Allows a custom input logic table to be defined for binary speed control mode, US04 Control Type = Binary Speed Selection (1).

To select this function, set LI03 Speed Input Decoding = Decode with LI16.

Speeds are assigned the following values:

- 2 = Leveling
- 4 = Correction
- 6 = Inspection
- 8 = High
- A = Intermediate 1
- C = Intermediate 2
- E = Intermediate 3

The parameter is 7 digits, populated one digit at a time with the above values to create the decoding. The first, right-most digit corresponds to binary 001 and the seventh, left-most digit corresponds to binary 111 where I8>...>I1. Zero speed is fixed with binary 000.

I4	I3	I2	Digit
0	0	0	-
0	0	1	1 (Right-most)
0	1	0	2
0	1	1	3
1	0	0	4
1	0	1	5
1	1	0	6
1	1	1	7 (Left-most)

For example, the binary input logic table corresponding to the default setting of LI03 Speed Input Decoding = B(Level - Correction - Inspection), NUM = 0, would be LI16 = ECA8642 (note the order of the inputs).

Binary Speed Selection	Parameter	Control Inputs			LI16 Value
		I2	I3	I4	
S ZERO	-	X	X	X	-
S LEVELING	LS01	1	0	0	2
S HIGH	LS02	0	0	1	8
S INSPECTION	LS03	1	1	0	6
S CORRECTION	LS04	0	1	0	4
S INTERMEDIATE 1	LS05	1	0	1	A
S INTERMEDIATE 2	LS06	0	1	1	C
S INTERMEDIATE 3	LS07	1	1	1	E

LI - Input Parameters

LI20

Brake Switch Function

Sets the response to a Brake Switch Failure fault, when an input is assigned as Brake Release Confirmation.

Setting:	Description:	NUM
General Reset	Brake switch faults will automatically reset up to the number of times adjusted in LX01.	0
Auto Reset	The brake switch fault will only reset 3 times, regardless of the LX01 setting.	1
Forced Resets	A manual reset of the fault on the drive is required (F1+F4), even after a power cycle. No auto reset is possible.	2
Default = General Reset (0)		

6.3 LM - Motor Data Parameters

These parameters define and display all relevant motor values and motor protection settings. The drive will only allow access to motor parameters related to the motor loaded in US03.



A change to any of the motor data parameters will recalculate the LC30 Maximum Torque to 150% to protect the motor from any misadjustments. Although this setting may be too low to run on automatic speed, upon verification of proper operation and normal current draw on inspection speed, the LC30 Maximum Torque value can be raised. Adjustments are typically in the range of 200 - 250% for normal high speed operation.

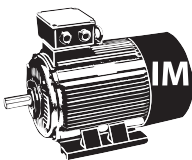

Parameters that pertain to induction motors will have the following icon listed beside it.



Parameters that pertain to permanent magnet motors will have the following icon listed beside it.

LM01

Motor Power

The rated power of the motor, according to nameplate. The unit will be either HP or kW, according to the US02 System Units setting.

Conversion:

- 1 kW = 1.36 HP
- 1 HP = 0.735 kW

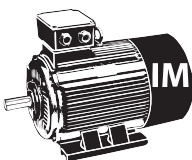

For induction motors, enter the nameplate motor power



For PM Synchronous Motors, the rated power is calculated from the rated motor speed (LM02) and rated motor torque (LM07) and is therefore **read-only**. Refer to LM07 Motor Torque for further details.

LM - Motor Data Parameters

LM02

Motor Speed

The rated motor speed in rpm, according to nameplate.

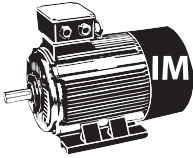

You may **NOT** enter the motor-synchronous speed (e.g. 1200 rpm for a 6 pole, 60Hz motor). Ask the motor manufacturer for the motor rated speed. If you cannot find it on the name plate, use the following example to estimate the rated speed.

Example:

If the nameplate reads 1200 rpm (synchronous speed) then the value that should be entered must be lower. For starting purposes, one can estimate the slip at about 2.9%. Then through running the elevator it is possible to determine whether further adjustments are necessary. 2.9% of 1200 is 35 rpm. To begin with, use the value $1200 - 35 = 1165$ rpm which is the default value.

Valid Adjustment Range for 60Hz motors:

From this parameter along with the LM04 Motor Frequency, the F5 Elevator Drive calculates the number of motor poles. As a result there are limits as to how low the value can be adjusted for a motor with a certain number of poles.

The following shows the valid adjustment range of 60Hz motors.

- 4 poles: 1201...1799 rpm
- 6 poles: 901.....1199 rpm
- 8 poles: 721.... ..899 rpm
- 10 poles: 601.... ..719 rpm

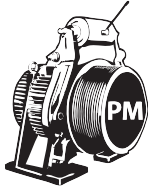

For PM Synchronous Motors, the relationship between the rated motor speed, rated motor frequency and the number of motor poles **MUST NOT** include any slip.

For a given number of motor poles, the rated motor speed or frequency should be verified against the nameplate values and changed accordingly in the drive, as rounding may occur on the nameplate. The number of motor poles will always be an even, whole number. If it is not known, then it may be obtained from the motor manufacturer based on frame model of the motor.

Otherwise, the following equation can be used to estimate the number of motor poles. If the following equation yields a result near an odd number, contact the motor manufacture to determine the correct number of motor poles.

$$\text{Motor Speed (RPM)} = \frac{\text{Rated Motor Frequency (Hz)} * 120}{\# \text{ of Motor Poles}}$$

$$\text{LM02} = \frac{\text{LM04} * 120}{\# \text{ of Motor Poles}}$$

$$\text{LM04} = \frac{\text{LM02} * \# \text{ of Motor Poles}}{120}$$

$$\# \text{ of Motor Poles} = \frac{\text{Rated Motor Frequency (Hz)} * 120}{\text{Motor Speed (RPM)}}$$

Once the correct number of motor poles has been determined as a whole, even number, then the equation can be rearranged to solve for either the rated motor speed or rated motor frequency, according to the equations above.

It is not important whether the rated motor speed or rated motor frequency is changed to accurately reflect the number of motor poles as long as the equation holds true, although it may be best to keep the rated motor speed fixed to reflect the actual motor speed at high speed and solve for frequency.. It is recommended to perform this calculation to verify no rounding has occurred for these values on the nameplate motor data. If this equation does not hold true, the result may be higher current draw to produce a given torque.

LM - Motor Data Parameters

Example:

The motor nameplate reads 95 rpm, 15 Hz.

Solving for the number of motor poles, we get:

$$\begin{aligned}\# \text{ of Motor Poles} &= \text{Rated Frequency (Hz)} \times 120 / \text{Rated Speed (rpm)} \\ &= 15 \text{ Hz} \times 120 / 95 \text{ rpm} \\ &= 18.94 \text{ Motor Poles}\end{aligned}$$

Here, the number of motor poles is approximately 19. The number is not even. This would indicate either the motor rated speed or frequency listed on the nameplate was incorrect. Additionally, it cannot be determined whether the correct number of motor poles should be either 18 or 20. In this case, contact the motor manufacturer to confirm.

For this example, assume the motor manufacturer confirmed the number of pole pairs to be 20. With this, we can assume either the rated motor speed of 95 rpm is correct or the rated motor frequency of 15 Hz is correct, then solve for the other. Here, we will chose the 95 rpm be correct and solve for the rated motor frequency, given a 20 pole motor:

$$\begin{aligned}\text{Rated Frequency (Hz)} &= \text{Rated Speed (rpm)} \times \# \text{ of Motor Poles} / 120 \\ &= 95 \times 20 / 120 \\ &= 15.8 \text{ Hz}\end{aligned}$$

Or, equivalently if the rated motor speed is assumed to be 95 rpm.

$$\begin{aligned}\text{Rated Speed (rpm)} &= \text{Rated Frequency (Hz)} \times 120 / \# \text{ of Motor Poles} \\ &= 15 \times 120 / 20 \\ &= 90 \text{ rpm}\end{aligned}$$

LM03

Motor Current

The rated motor current in amperes, according to nameplate.

LM04

Motor Frequency

The rated motor frequency in Hz, according to nameplate.



FOR PM SYNCHRONOUS MOTORS, the relationship between the rated motor speed, rated motor frequency and the number of motor poles MUST NOT include any slip. For a given number of motor poles, the rated motor speed or frequency should be verified against the nameplate values and changed accordingly in the drive, as rounding may occur on the nameplate. Refer to parameter LM02 Motor Speed for details.

LM05

Motor Voltage

Rated motor voltage, according to nameplate.

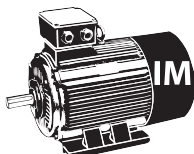

For induction motors, enter the rated motor voltage according to nameplate.



For PM motors, enter the no load phase-to-phase back EMF rms voltage at rated speed. This particular unit for voltage is not typically listed on the nameplate. As a starting point, the nameplate voltage can be entered.

This value can be determined by performing a motor tune, described further under LL01 Motor Tune or Section 5.9 Motor Learn. As mentioned above, the learned value may differ from the nameplate value, due to units; the learned value will typically be lower than what is listed on the motor nameplate. After a Motor Tune has been performed, there should be no reason to change the learned value.

LM - Motor Data Parameters

LM06

Motor Power Factor

The motor power factor, according to nameplate.

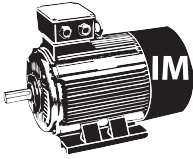

This parameter is not the efficiency of the motor but the ratio of the magnetizing current to the total phase current of the motor. Lower power factor values will increase the magnetizing current to the motor and thus increase the field strength resulting in tighter control of the motor. Higher values decrease the magnetizing current and the field strength.



If not known, a value of 0.9 is recommended for old high slip motors and a value of 0.75 is recommended for gearless induction motors.

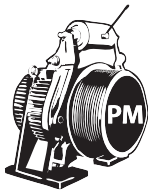

This parameter is not applicable to PM Synchronous motors and therefore will not appear.

LM07

Motor Torque

The rated motor torque in lb-ft or Nm, depending on selection of US02 System Units.

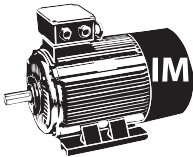

For IM the torque value is calculated from the rated speed (LM02) and rated power (LM01) and is therefore **read-only**. Refer to Motor Power (LM01).



For PM motors the torque value must be entered and is used to establish the torque constant. Enter the rated name plate torque.

Since the desired unit for rated motor torque may not appear on the motor nameplate, below are the appropriate conversions:

- $\text{lb-ft} = \text{HP} \times 5258 / \text{Rated Speed (rpm)}$
- $\text{lb-ft} = \text{kW} \times 7043 / \text{Rated Speed (rpm)}$
- $\text{lb-ft} = \text{Nm} / 1.355$
-
- $\text{Nm} = \text{HP} \times 7125 / \text{Rated Speed (rpm)}$
- $\text{Nm} = \text{kW} \times 9543 / \text{Rated Speed (rpm)}$
- $\text{Nm} = \text{lb-ft} \times 1.355$

LM08

Electric Motor Protection

This parameter is used to activate and select the type of motor overload function. Depending on the setting of this parameter, the Elevator Drive will trigger an 'Error Motor Protection' fault causing the motor to stop.

Settings:	NUM
Off	0
On	1
Default = On (1)	

The trip curve is in accordance with VDE 0660 Part 104, UL508C section 42, and NFPA 70 Article 430 part C. It is defined as follows:

- 100% of trip current => continuous running
- 120% of trip current => trip after 2 hours
- 150% of trip current => trip after 2 minutes
- 200% of trip current => trip after 1 minute
- 800% of trip current => trip after 5 seconds

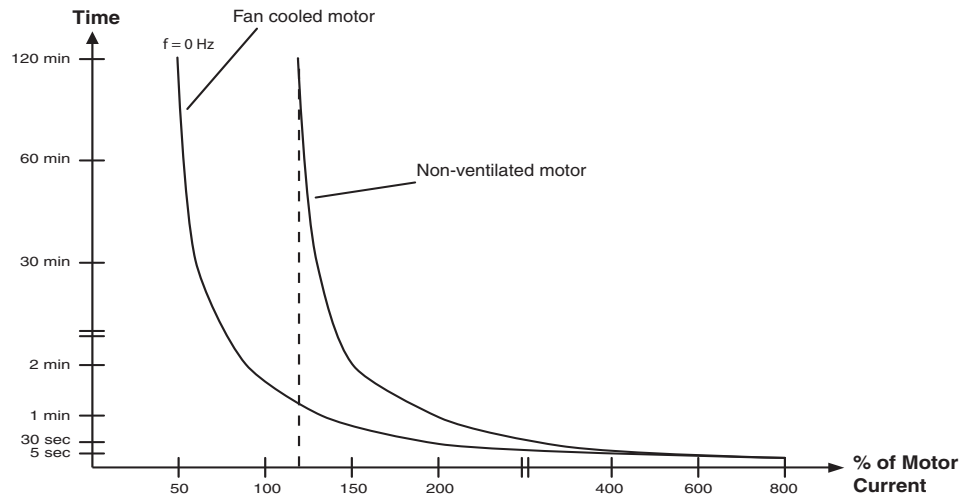

This function must be activated to ensure the motor protection function is operational!

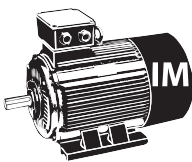

The trigger level is established in parameter LM09 Electric Motor Protection Current.



The trigger level is established from the LM03 Motor Rated Current and LM11 Peak Motor Current Factor. Refer to LM11 Peak Motor Current Factor for additional details.

LM - Motor Data Parameters

LM09

Current level for Electric Motor Protection.

Electric Motor
Protection Current

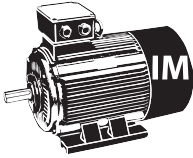

This parameter sets the current threshold in amps above which the Elevator drive activates the motor overload function, described in LM08 Electric Motor Protection.

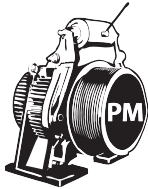

For PM motors the current threshold for electronic motor protection is set equal to the rated motor current in LM03 and therefore does not appear. Additionally, some motors must be protected from long term peak current to prevent damage to the motor windings. For additional settings and details, refer to LM11 Peak Motor Current Factor.

LM10

Motor Overheat Temp.

If one of the outputs is configured as Motor Overheat warning (LO05, LO10, LO15 or LO20) the temperature at which the warning is triggered can be set.

Unit: Degree Celsius

If the motor utilizes a KTY thermistor for temperature detection then the trigger temperature can be set directly. In addition, the drive hardware must support KTY a sensor.

If the motor utilizes a PTC thermistor or relay for overheat detection, then drive will trigger based on the thermistor resistance or open relay. Refer to Section 2.8 for further details on PTC tripping and reset resistances.

LM11

Peak Motor Current
Factor

Peak motor current factor for drive overload error for PM motors.

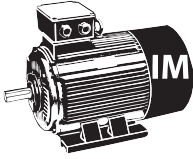

This parameter is not applicable to Induction Motors and therefore will not appear.

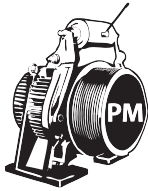

For PM motors the current limit for electronic motor protection is set equal to the rated motor current in LM03. Some motors must be protected from long term peak current to prevent damage to the motor windings. This parameter is then used to limit the peak current to the motor. If the motor current exceeds this value for longer than 3.0 seconds, the drive will automatically trigger the 'Error Motor Protection' fault and shut down operation.



When adjusting the rated motor current in LM03, this value is automatically set to 200% of the LM03 Motor Current. After setting LM03, this parameter can then be adjusted based on the max. current allowed by the motor manufacturer.

If this parameter is set too low, it may interfere with operation of the elevator resulting in shut downs, particularly during acceleration.

This parameter will not limit the maximum current output. It is only used to start the timer which would trigger an 'Error Motor Protection' fault. Refer to LC30 Maximum Torque for issues with current limiting.

If the LC30 Maximum Torque is set lower than LM11, peak current will be limited to the corresponding LC30 value and this function cannot be realized. Likewise, if the LM11 value is set to a value corresponding to current greater than the drive peak current rating (Refer to Section 2.4 or 2.5), then this function cannot be realized.

LM - Motor Data Parameters

LM20

Motor Ls

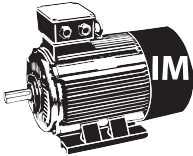

The equivalent induction motor sigma inductance. This value is calculated from the per phase stator and rotor leakage inductances.

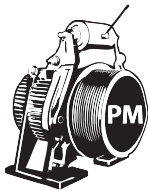

This is the total phase-to-phase reflected leakage inductance of the motor stator winding. The inductance listed on the manufacturer's data sheet may likely be for one phase. So, it may be necessary to multiply the value by two and then enter it into the drive. Incorrect settings of this parameter could lead to oscillation in the current control since the regulator values for the current control are calculated from this value.



This value can be learned for either motor type with a Motor Tune. Refer to Section 5.9 Motor Learn for further details.

LM21

Motor Rs

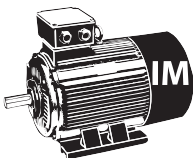

The per phase induction motor stator resistance in ohms.



For PM motors this is the phase-to-phase resistance value of the stator. Motor manufacturers may list the per phase value; therefore you must multiply by two. Incorrect settings of this parameter could lead to oscillation in the current control and audible noise in the motor, since the regulator values for the current control are calculated from this value.



This value can be learned for either motor type with a Motor Tune. Refer to Section 5.9 for further details.

LM22

Motor Rr

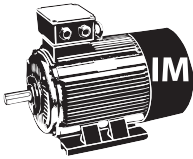

This is the per phase induction motor rotor resistance.

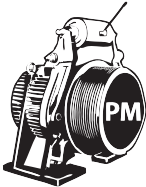

This parameter is not applicable to PM Synchronous motors and therefore will not appear.



This value can be learned with a Motor Tune. Refer to Section 5.9 for further details.

LM23

Motor Lm

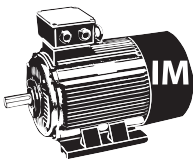

This is the per phase induction motor magnetizing inductance. The magnetizing inductance can be monitored from Diagnostics Screen #1 or in parameter DG09. If the actual magnetizing current is too high, lower this inductance value in steps of 20. If it is too low, raise the value.

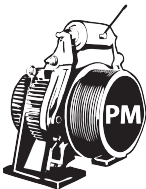

This parameter is not applicable to PM Synchronous motors and therefore will not appear.



This value can be learned with a Motor Tune. Refer to Section 5.9 for further details.

LM - Motor Data Parameters

LM24

Field Weakening
Corner

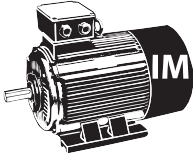

The field weakening speed determines at which speed the peak torque limit starts being reduced. It is necessary to reduce the peak torque limit of the motor since the drive's ability to force current into the motor is limited by the applied voltage as rated speed is reached.

If the drive tries to demand more torque than the motor can produce given the available voltage and actual motor speed, it is possible that the breakdown torque of the motor will be exceeded and as a result the motor will appear to stall and run at less than desired speed.

Generally this phenomenon can be identified as the car reaches contract speed momentarily but then drops to a lower speed or the car speed stalls at some speed lower than contract speed. Monitor the Modulation Grade in the Diagnostic Screen #2 or DG.10. If the value is reaching 100% or higher, the voltage limit is being reached; this may be caused from a sag in the line voltage. As a result the peak torque command must be further limited in order to maintain control of the motor.

The solution is simply to reduce the value of LM24 to about 60% of synchronous speed (720 rpm for a 1,200 rpm motor). A setting of 45% of synchronous speed should be used as the practical lower limit of this parameter.

Motor Torque vs. Speed

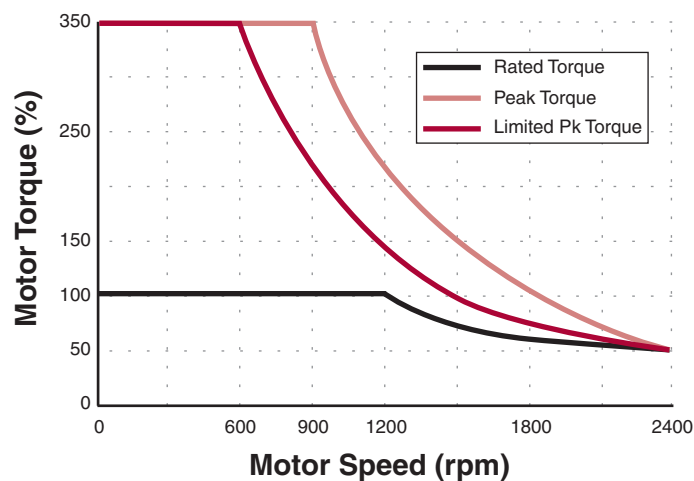

This parameter is not applicable to PM Synchronous motors and therefore will not appear.

LM25

Field Weakening
Speed

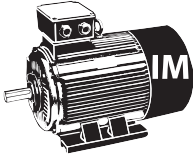

This parameter provides a better adjustment of the field weakening torque curve. Under certain situations, if the input voltage is sagging too low or the motor has very high slip, it is possible that the voltage limit might be reached. This can be confirmed by monitoring the Modulation Grade in the Diagnostic Screen #2 or DG.10. If the modulation grade reaches 100% or more the drive is operating at the voltage limit and potentially can cause poor control of the motor.

To prevent this from occurring the drive has an adjustable torque curve which prevents the voltage limit from being reached. The value of this parameter is normally calculated when the motor data is loaded in the LM parameters. After entering the data, this value can be fine tuned.

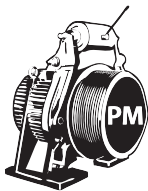
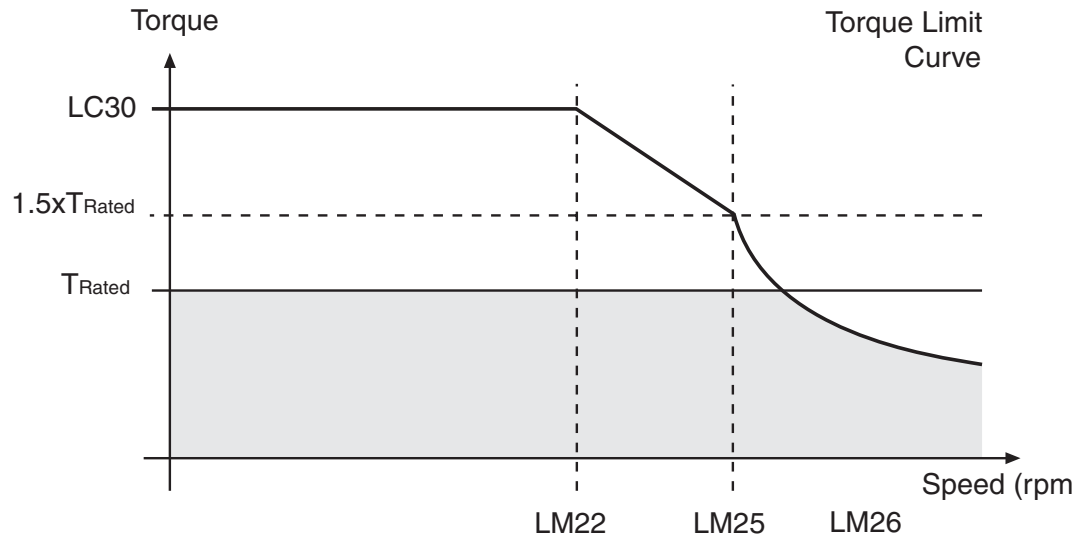

This parameter is not applicable to PM Synchronous motors and therefore will not appear.

LM - Motor Data Parameters

LM26

Motor Ls Max

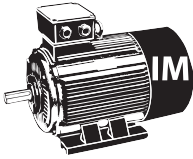

This parameter is not applicable to Induction motors and therefore will not appear.

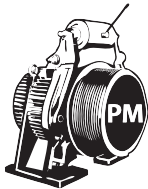

Maximum motor inductance.



This value can be learned with a Motor Tune. Refer to Section 5.9 for further details.

LM27

Motor Inductance Mode

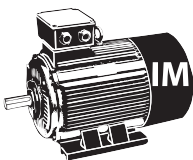

This parameter is not applicable to Induction motors and therefore will not appear.

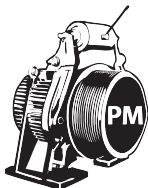

This parameter selects the relationship between the motor rated and maximum inductances. It is determined by the drive and is used as part of the LL05 SPI function. If the LM01 Motor Tune has been completed, this parameter should not need adjustment and is only available for advanced troubleshooting.

Settings:	NUM
Ld <> Lq	0
Ld = Lq	1
Default = Ld <> Lq (0)	



This value can be learned with a Motor Tune. Refer to Section 5.9 for further details.

LM30

Motor Control

This parameter activates various controllers in the drive. Multiple options may be selected, in which the NUM value is the sum of the options selected.

Setting:	Description:	NUM
Motor Model	Turns on motor model. The drive will automatically active the motor model after the LM01 Motor Tune has been completed successfully.	1
Vmax Regulation	Refer to LM31 for further details.	2
Flux Control	Activates flux control. This setting only applies to Induction motors. The drive will automatically active the flux control after the LM01 Motor Tune has been completed successfully.	4
Flux Proofing	Ensures sufficient flux build up before activating Drive On or Brake Control outputs. This setting only applies to Induction motors.	8
Zero Speed Model	Keeps the motor model active at zero speed.	16
Default* = Vmax Regulation (2)		

*After a LL01 Motor Tuning has been performed, the Motor Model will be turned on and for Induction motors, Flux Control will also be turned on.

LM31

Vmax Regulation

Sets the maximum output voltage level as a percentage of the available with 100% equal to the maximum available. The drive will attempt to regulate the output voltage from going above this value by reducing the magnetizing current of induction motors or de-fluxing for PM motors. The nominal value is 97% which will regulate the voltage to just under 100%.

LM32

KP Current

Current control proportion gain. Calculated from motor data. This parameter should not need adjustment and is only available for advanced troubleshooting.

LM33

KI Current

Current control integral gain. Calculated from motor data. This parameter should not need adjustment and is only available for advanced troubleshooting.

LE - Encoder Parameters

6.4 LE - Encoder Data Parameters

X3A Encoder Input 1

Parameter LE1...LE17 correspond to encoder interface 1, X3A.

LE01

Encoder Interface

This parameter displays the type of encoder feedback card installed in the drive.

This parameter is also used to reset 'Error Encoder Interface' faults. If an 'Error Encoder Interface' fault has occurred, and the problem has been corrected, the error can be reset by displaying the value of LE01 and pressing ENTER. This is the only way to manually reset the 'Error Encoder Interface' fault.

LE02

Encoder 1 Pulse
Number

Enter the encoder pulses per revolution (ppr) listed on the encoder. This refers to the encoder input X3A.



Higher encoder pulses per revolution can be supported. Refer to LE09 and LE10 for further details.



If the incremental encoder pulse number is not correctly adjusted, the motor can run very slowly and draw high current, run to fast and OVERSPEED IS POSSIBLE, or other unforeseen conditions may occur. Therefore, it is absolutely necessary to adjust this parameter correctly.

LE03

Swap Encoder 1
Channels

This parameter is used to invert the A and B incremental channels and/or invert the direction of motor rotation.

Setting:	Description:	NUM
Not Inverted	No changes are made to A/B or direction of rotation.	0
A-B Swapped	Encoder channels A and B are swapped internally.	1
Inverted Rotation	The direction of motor rotation is inverted	2
A-B Swap & Inverted Rotation	Encoder channels A and B are swapped internally, and the direction of motor rotation is inverted.	3

Default = Not Inverted (0)



For PM Synchronous Motors, if the A/B Channels are swapped, the encoder pole position value in LE06 will have a different corresponding value and must be relearned. See Section 5.10 for additional information.

For PM motors, the direction of rotation should not be changed by swapping motor phases.

LE04

Sample Rate for Encoder 1

This parameter is used to adjust the sample time of the encoder feedback for calculation of the actual motor speed value. With certain motors or encoders it may be beneficial to use a time other than the factory setting. Lower values lead to higher bandwidth and faster response times of the motor. However lower values also increase the systems susceptibility to electrical noise on the encoder signal. Therefore on some systems having higher noise levels, lower values may not be suitable. If this electrical noise is a problem, the motor will produce an audible noise or vibration while running. If this is the case, try increasing the rate by one step (e.g. from 4ms to 8ms) as a way to filter electrical noise.

Settings:	NUM
0.5 msec(2 kHz)	0
1 msec (1 kHz)	1
2 msec (500 Hz)	2
4 msec (250 Hz)	3
8 msec (125 Hz)	4
16 msec (63 Hz)	5
32 msec (31 Hz)	6
Default = 4 msec (250 Hz) (3)	

LE05

Encoder 1 Multiplier

This parameter can be used to increase the resolution of encoders with analog sine/cosine tracks. The encoder types are EnDat, SIN/COS, SSi, and Hiperface. For incremental encoders, adjustment of this parameter has no effect; internally, the value will be set to a value of 2 due to the TTL pulse tracks.

Default Setting (Gearless modes) = 8

Default Setting (Geared modes) = 2



The value corresponds to the multiplier using the following relation:

$$\text{Actual Encoder Resolution} = \text{Encoder base ppr (LE02)} \times 2^{(\text{LE05})}$$

Example:

EnDat encoder with base resolution of 2048 ppr.

With LE05 = 8 the actual measured resolution is:

$$2048 \times 2^8 = 524288 \text{ counts / rev}$$

Higher values give better resolution especially for gearless applications. However values too high may make the system more susceptible to disturbances due to noise. Therefore the actual value which can be used will ultimately be limited by the noise being picked up on the encoder cable. In gearless applications, very low values will sacrifice resolution and may cause audible electrical noise from the motor. A setting of 8 is typical for absolute encoders (e.g. EnDat).

LE - Encoder Parameters

LE06

Encoder 1 Pole Position



This parameter displays the position of the encoder in relation to one of the motor poles. This may often be referred to as the encoder position.

The parameter is only applicable to PM Synchronous motors. Refer to Section 5.10.1 or 5.10.2 for the procedures to learn the pole position.



The pole position must be known for proper operation of a PM Synchronous motor. Failure to learn the pole position may result in excessive current draw and may result in loss of control.

If the encoder A/B channel phasing is swapped, there would be a different corresponding Encoder Pole Position and should be relearned.

The pole position represents an encoder offset in relation to the rotor aligned to a motor pole. If at any time this physical relationship is changed (e.g. encoder replaced/removed, encoder slippage), the pole position must be re-established for proper operation. If the encoder position is relearned and found to be more than 2,000 from the previous value, this is an indication of the encoder mounting issues. Even if the encoder appears to be mounted tight to the motor shaft, a small amount of slippage may accumulate over time or even distance; likewise, encoder mounting issues may appear due to changes in direction.

LE07

Rotor Detection Mode



This parameter determines when the drive will automatically determine the pole position for a PM Synchronous motor.

For incremental encoders, there is no way to determine whether the rotor position has changed after the pole position has been learned if the encoder has been powered down since the encoder only provides generic pulses instead of a unique position. In this case, it is mandatory that the pole position at least be determined before the first run after every power cycle.

Setting:	Description:	NUM
Off	The function is turned off.	0
Every Run	The pole position is learned before each run is performed.	1

Default = Off (0)

LE08

Encoder Scaling

For encoders whose ppr exceeds that accepted by the encoder feedback card, encoder scaling can be enabled. Refer to the example below and LE09 Encoder 1 Numerator and LE10 Encoder 1 Denominator for further details.

Setting:	Description:	NUM
Off	The function is not activated. The encoder pulses per revolution from LE02 is used directly.	0
Reserved	No function	1
LE02 x LE09 / LE10	The LE02 pulses per revolution	2
Default = Off (0)		



Example:

An incremental encoder is listed as 36000 ppr. The maximum acceptable ppr for the incremental encoder feedback interface card is 16384. In this case, the LE02 Pulse Number can be set to 9000, the LE09 Enc1 Numerator can be set to 4 and the Enc1 Denominator can be set to 1. Now, if the encoder scaling is activated by setting LE08 Encoder Scaling = LE02 x LE09 / LE10, then the encoder pulses per revolution is scaled back to $9000 \times 4 / 1 = 36,000$ ppr.

LE09

Encoder 1 Numerator

Numerator of encoder scaling factor when enabled with the setting of LE08 Encoder Scaling = LE02 x LE09 / LE10.

LE10

Encoder 1 Denominator

Denominator of encoder scaling factor when enabled with the setting of LE08 Encoder Scaling = LE02 x LE09 / LE10.

LE - Encoder Parameters

LE11

Serial Encoder 1 Type

Encoders with serial communication to the drive (e.g. EnDat, SSi, Hiperface, BiSS) can identify their type and would be displayed in this parameter.

LE12

Serial Encoder 1
Status

Encoders with serial communication to the drive (e.g. EnDat, SSi, Hiperface, BiSS) can identify their connection status and errors to the drive and would be displayed in this parameter. The table below lists common status messages. For further troubleshooting, refer to 'Error Encoder Interface' in Section 7.2.

Display:	Description:	NUM
Position Transfer	Connected - Serial Comm. established	16
No comm. to encoder	Bad Cable - Incremental Channel	67
No comm. to encoder	Bad Cable - Absolute Channel	68
Encoder count inc.	Position Deviation	69
Ec.1 diff. to enc. typ	PPR setting doesn't match encoder	70
Encoder formatting		92
New encoder interface identifier	New encoder detected	96
No comm. to interface	Encoder not connected or serial type. This will be displayed with TTL incremental encoders.	255

LE13

UVW Encoder
Commutation

The number of commutation poles for a UVW encoder. In general, the number of UVW encoder and motor poles should be the same; if different, it is possible to adjust the number of UVW encoder poles. **This parameter is only relevant when the encoder type is UVW.**

Default = '= motor pairs of poles' (NUM = 0)

LE14

Serial Encoder 1
Selection

The type of encoder serial protocol. **This parameter is only functioning when the BiSS/EnDat 2.2 encoder interface card is installed.**

Settings:	NUM
EnDat 2.2	0
BiSS Hengstler Acuro	1
BiSS C-Mode	2
Default = EnDat 2.2 (0)	

LE15

PT1 Time Encoder 1

Low pass filter on speed of the measured speed value.

LE16

SSi Data Format

Sets the data format of the SSI transmission between encoder and inverter.

Settings:	NUM
Binary	0
Gray Scale	1
Default = Binary (0)	

LE17

SSi Data Resolution

Sets the resolution of the data of the SSI transmission.

LE - Encoder Parameters

X3B Encoder Output / Input 2

Parameters LE31...LE36 correspond to encoder interface 2, X3B.

- Parameters LE32...34, 36 correspond to encoder interface 2, X3B as an input.
- Parameter LE35 correspond to encoder interface 2, X3B as an output.

LE31

Encoder 2 Interface

This parameter displays the type of encoder feedback for X3B.

LE32

Encoder 2 Pulse
Number

This refers to X3B as an encoder **input**. Enter the encoder pulses per revolution (ppr) listed on the encoder.

LE33

Swap Encoder 2
Channels

Refer to parameter LE03 for description.

LE34

Sample Rate for
Encoder 2

Refer to parameter LE04 for description.

LE35

This parameter selects the output ppr for the encoder output channel X3B.

Encoder 2 Output PPR

Function:	Settings:	Description:	NUM
Source	Channel 1	The increments of the encoder at Channel 1 (X3A) are output via encoder emulation at Channel 2 (X3B). When Source = Channel 1 is selected, the emulated encoder output can be further divided by the Division factor.	0
	Channel 2	This value has no function since there is no encoder interface with encoder emulation available via Channel 1 (X3A).	1
	Actual Value	The increments of the encoder, whether measured or calculated (eg. LE08 Encoder 1 Scaling), are output via the emulation at Channel 2 (X3B). When Source = Actual Value, the increments per revolution of the output emulation must be selected from Actual Value.	2
	Reserved	-	3
Actual Value	256	The number of increments per revolution which are output via encoder emulation at Channel 2 (X3B) when Source = Actual Value.	0
	512		4
	1024		8
	2048		12
Division	Direct	The increments of the encoder Channel 1 (X3A) are output directly at Channel 2 (X3B). Always use this adjustment if Source = Actual Value.	0
	2	The increments of encoder Channel 1 (X3A) can be divided and output via encoder emulation at Channel 2 (X3B) by the selected factor when Source = Channel 1.	16
	4		32
	8		48
	16		64
	32		80
	64		96
	128		112
Default = Actual Value + 1024 + Direct (10)			

LE - Encoder Parameters

LE36

Refer to parameter LE15 for description.

PT1 Time Encoder 2

6.5 LN - Machine Data Parameters



The following parameters relate to the machine data of the elevator. It is important to enter the correct values, such that both the motor and the car run at the correct speed and the drive's internal Overspeed Error limit is calculated correctly. The drive uses the following equation to calculate the motor speed in RPM from the machine data parameters.

LN01

Traction Sheave Diameter

The diameter of the sheave in either inches or mm, depending on US02 System Units (ft/min or m/s). Ideally this value would be measured from the center of the rope.

$$\text{RPM} = \frac{12 \times \text{LN02 Gear Reduction Ratio} \times \text{LN03 Roping Ratio} \times \text{FPM Speed}}{\text{LN01 Traction Sheave Diameter} \times 3.141}$$

$$\text{RPM} = \frac{12 \times \text{LN02 Gear Reduction Ratio} \times \text{LN03 Roping Ratio} \times \text{m/s Speed} \times 0.00508}{\text{LN01 Traction Sheave Diameter} \times 3.141}$$

LN02

Gear Reduction Ratio

The gear ratio, X:1. If the gear ratio is unknown, refer to parameter LN05.

Once the car is running on high speed, if the measured speed is slightly above or below the contract speed, the gear ratio can be changed slightly to compensate. Higher values in LN02 will increase the car speed, lower values will decrease the car speed. Make very small changes at first!



For geared machines with an unknown ratio, the LN05 Estimated Gear Reduction Ratio can be entered in LN02; refer to LN05 for additional information. The gear ratio can also be determined by counting the revolutions of the motor during one revolution of the traction sheave.

LN03

Roping Ratio

The roping ratio, X:1.

LN - Machine Data Parameters

LN04

Load

The load capacity of the elevator, in lbs or Kg, depending on US02 System Units (ft/min or m/s).

This parameter has no function and is only used for reference.

LN05

Estimated Gear
Reduction Ratio

This parameter can be used to estimate the gear ratio if it is not known.

After correctly entering values into LM02 Motor Speed, US06 Contract Speed, LN01 Traction Sheave Diameter, LN03 Roping Ratio, read this value and then enter this value into LN02 Gear Reduction Ratio.

Then, to verify, run the car at inspection speed, measure the actual speed with a hand tach. If the car speed is slower than the adjusted LS03 Inspection Speed, then increase LN02 Gear Reduction Ratio. If it is higher than the adjusted inspection speed, decrease LN02 Gear Reduction Ratio.

6.6 LS - Speed Profile Parameters



The inputs for each of the normal operating speed LS01-LS07 will be determined by the US04 Control Type and LI03 Speed Input Decoding. Refer to these parameters for logic tables and further details.

Additional special speed LS08-LS10 can be programmed with Input Functions LI04-LI11. Refer to these parameters for further details.

All speeds will use the LS43-45 deceleration and jerk settings for the Final Stop portion of the profile.



With discrete speed selections, US04 Control Type = Binary Speed Selection (1), Digital Speed Selection (0), or Serial Binary Speed DIN66019 Service 50 (6), a higher speed than leveling or correction cannot be accepted. That is, for example, if Leveling Speed is selected then the High Speed is selected afterwards, the drive will not accept the High Speed command and continue at Leveling Speed unless zero speed is selected between Leveling Speed and other higher speed selection.

If the Inspection Speed is selected when the drive enable is signaled, the inspection profile (LS50-55) will be loaded. During an inspection run, all other speed commands are ignored, except for Leveling Speed.



For analog speed control, US04 Control Type = Bi-Polar Analog Speed (3), Absolute Analog Speed (2), a speed for LS02 High Speed must be entered. This adjusts the run speed to 10V input. Reducing this value will lower the speed of the elevator (i.e. for testing purposes).



For serial speed control, US04 Control Type = Serial Speed DIN66019 Service 49 (4), Serial Speed DIN66019 Service 50 (5), a speed for LS02 High Speed must be entered.

LS - Speed Profile Parameters

LS01

Leveling Speed

Leveling speed. During Leveling Speed, a higher selected speed will be ignored unless zero speed is commanded beforehand.

Max. Value: 25 fpm

LS02

High Speed

High Speed. This speed setting uses the High Speed profile settings LS20-25 and LS27 Correction Distance.



The High Speed must also be set when US04 Control Type = Bi-Polar Analog Speed (3), Absolute Analog Speed (2), Serial Speed DIN66019 Service 49 (4), Serial Speed DIN66019 Service 50 (5)

Max. Value: US06 Contract Speed

LS03

Inspection Speed

Inspection Speed. This speed setting uses the Inspection Speed profile settings LS50-55. If the Inspection Speed command is present when the drive is enabled, the inspection profile will be loaded. During the inspection speed profile, all other speeds except Leveling Speed will be ignored.

Max. Value: 150 fpm (0.63 m/sec)

LS04

Correction Speed

Correction Speed, also known as High Leveling Speed. During Correction Speed, a higher selected speed will be ignored unless zero speed is commanded beforehand.

Max. Value: 50 fpm

LS05

Intermediate Speed 1

Intermediate Speed 1. This speed setting uses the One Floor Speed profile settings LS30-35 and LS37 Correction Distance. Max. Value: US06 Contract Speed

LS06

Intermediate Speed 2

Intermediate Speed 2. This speed setting uses the One Floor Speed profile settings LS30-35 and LS38 Correction Distance. Max. Value: US06 Contract Speed

LS07

Intermediate Speed 3

Intermediate Speed 3. This speed setting uses the Emergency Speed profile settings LS40-45 and LS47 Correction Distance. Max. Value: US06 Contract Speed



Intermediate Speed 3 uses the profile settings labeled as Emergency Speed.

LS08 - 10: Special Function Speeds

To utilize these special function speeds, an input must be assigned in LI04-11.

LS08

Earthquake Speed

Run speed when selected by an input programmed for Earthquake Speed is activated before the start of the run. The High Speed, Intermediate Speed 1, Intermediate Speed 2, and Intermediate Speed 3 selections are limited to this speed.

Max Value: 150 fpm

LS09

Emergency Power
Speed

Active when an input programmed for Emergency Power Speed is activated before the run. All speeds adjusted higher than this speed are limited to this value.

Max. Value: US06 Contract Speed

LS10

Battery Operation
Speed

Run speed when selected by an input programmed for UPS Operation is active before the start of the run. All speeds are limited to this value.

Max. Value: 50 fpm

LS - Speed Profile Parameters

Preset profiles, LS15-LS17

Preset profile settings are available for selection based on type of desired profile. The presets will automatically adjust the acceleration, deceleration and jerk rates for a corresponding speed selection. 'Soft' settings will have a relaxed profile, while 'Hard' settings will have a quicker, more aggressive rates. If changes are made to any of the pre-setting, the option will reflect this by displaying 'Custom' to indicate changes have been made.

Settings:	NUM
Default = Custom (0)	
Custom	0
Soft	1
Medium	2
Hard	3
Profile Mode (High Speed Profile only)	
External Profile	0
Internal Profile	4
Default = Custom (0)	



When US04 Control Type = Bi-polar Analog Speed (3), Absolute Analog Speed (2), Serial Speed DIN66019 Service 49 (4), Serial Speed DIN66019 Service 50 (5), the speed profile is generated externally by the controller and the drive's ramp generator is turned off. It is possible to override the external profile and utilize the drive's internal profile with LS15 = Internal Profile; refer to LS15 for additional information. When US04 Control Type = Binary Speed Selection (1), Digital Speed Selection (0), or Serial Binary Speed DIN66019 Service 50 (6), only Internal Profile Mode is actually used and setting for External Profile in LS15 is ignored.

LS15

High Speed Profile

Preset speed profile for High Speed profile.

Additionally, there is the option Internal Profile (4), in which the High Speed profile settings LS20-25 can be used to limit the rates of externally generated speed profiles from analog or serial speed control modes. That is, the profile will be generated by the drive when the rates are less than those dictated by the controller.

LS16

One Floor Profile

Preset speed profile for One Floor Speed profiles (Intermediate Speeds 1 and 2).

LS17

Emergency Profile

Preset speed profile for Emergency Speed profile (Intermediate Speed 3 or Emergency Profile input function).



The run profile is defined by jerks, acceleration, and deceleration. Different run profiles are available based on selected speed and/or input function (e.g. Emergency Profile). The speed profiles and corresponding parameters are broken down into the following groups:

- High Speed Profile LS20-27
- One Floor Profile (Intermediate Speeds 1, 2) LS30-38
- Emergency Profile (Intermediate Speed 3) LS40-47
- ESD/ETS Profile LS48-49
- Inspection Speed Profile LS50-55

Each profile will have the following settings*:

Acceleration
Starting Jerk
Acceleration Jerk

Deceleration
Deceleration Jerk
Stopping Jerk

*ESD Profile will only have deceleration and deceleration jerk settings.

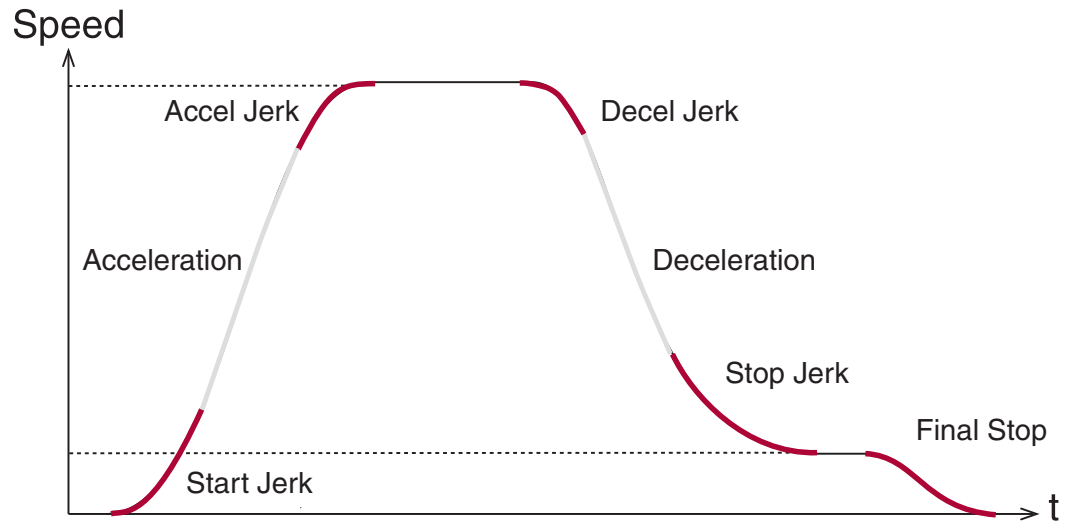

All speeds will use the LS43-45 deceleration and jerk settings for the Final Stop portion of the profile.

LS - Speed Profile Parameters

In general, higher values result in a hard/fast profile, while lower values give softer, slower transitions.

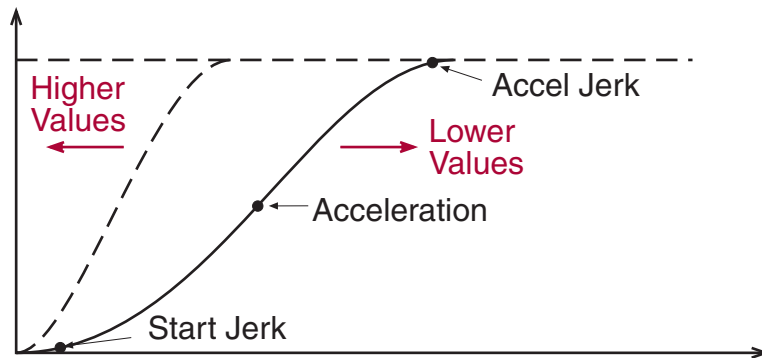

Empirical values:

2.00...3.00 for retirement homes, hospitals, apartment buildings

3.00...4.50 for office buildings, banks etc.



Each jerk rate will have a calculated minimum value depending on the value of the rate of acceleration or deceleration that the jerk must work with. Therefore the minimum jerk value is limited by the actual adjusted value of the acceleration or deceleration. If a lower jerk value is required, you must first reduce the rate of acceleration or deceleration.



For externally generated speed profile control modes, analog and serial speed control modes (US04 Control Type = Bi-polar Analog Speed (3), Absolute Analog Speed (2), Serial Speed DIN66019 Service 49 (4), Serial Speed DIN66019 Service 50 (5)), the profile is generated by the controller and the rates set in the drive will have no effect (except when ESD rates are used for emergency slowdown function) unless LS15 = Internal Profile.

Correction Speeds

In addition to profile rate settings, speed profiles High Speed, Inspection, Intermediate Speeds 1, 2, 3 will have an additional 'correction' parameter associated with each. The correction parameters are used to compensate leveling distance, when decelerating from the corresponding speed, by the amount adjusted. Refer to LS27 High Speed Correction for additional information.

High Speed Profile Rate Settings

LS20

Acceleration rate for High Speed profile.

Acceleration High
Speed

LS21

Start Jerk rate into acceleration for High Speed profile.

Start Jerk High Speed

LS22

Acceleration Jerk rate into high speed for High Speed profile.

Acceleration Jerk High
Speed

LS23

Deceleration rate for High Speed profile.

Deceleration High
Speed

LS24

Jerk rate out of high speed into deceleration for High Speed profile.

Deceleration Jerk High
Speed

LS25

Jerk rate out of deceleration into leveling speed.

Stop Jerk High Speed

LS27

The amount of leveling distance to be eliminated from a High Speed run.

High Speed Correction

This adjustment will cause additional time running at the run speed after the slowdown speed has been given in order to reduce the amount of time at leveling speed. A value of 0 will have no effect, whereas a value too large may lead to overshooting the floors. When decelerating from High Speed, it is necessary to transition directly from high speed to leveling. Selecting another speed in between will cancel the function.

LS - Speed Profile Parameters

One Floor (Intermediate 1, 2) and ETS Speed Profile Rate Settings

LS30

Acceleration One Floor

Acceleration rate for One Floor profile (Intermediate Speed 1 or 2).

LS31

Start Jerk One Floor

Start Jerk rate into acceleration for One Floor Speed profile (Intermediate Speed 1 or 2).

LS32

Acceleration Jerk One Floor

Acceleration Jerk rate into intermediate speed for One Floor Speed profile (Intermediate Speed 1 or 2).

LS33

Deceleration One Floor

Deceleration rate for One Floor Speed profile (Intermediate Speed 1 or 2).

LS34

Deceleration Jerk One Floor

Jerk rate out of intermediate speed into deceleration for One Floor Speed profile (Intermediate Speed 1 or 2).

LS35

Stop Jerk One Floor

Jerk rate out of deceleration into leveling speed for One Floor Speed profile (Intermediate Speed 1 or 2).

LS37

Intermediate Speed 1 Correction

The amount of leveling distance to be eliminated from run at Intermediate Speed 1. Refer to parameter LS27 for further description.

LS38

Intermediate Speed 2 Correction

The amount of leveling distance to be eliminated from run at Intermediate Speed 2. Refer to parameter LS27 for further description.

Emergency (Intermediate Speed 3) Profile Rate Settings

LS40

Acceleration
Emergency

Acceleration rate for Emergency Profile (Intermediate Speed 3 or Emergency Profile input).

LS41

Start Jerk Emergency

Start Jerk rate into acceleration for Emergency Profile (Intermediate Speed 3 or Emergency Profile input).

LS42

Acceleration Jerk
Emergency

Acceleration Jerk rate into speed for Emergency Profile (Intermediate Speed 3 or Emergency Profile input).



All speeds will use the LS43-45 deceleration and jerk settings for the Final Stop portion of the profile. Additionally, for analog and serial speed control modes, if the direction is dropped before zero speed has been reached, these rates will be used for the final deceleration.

LS43

Deceleration
Emergency

Deceleration rate for Emergency Profile (Intermediate Speed 3 or Emergency Profile input).

LS44

Deceleration Jerk
Emergency

Jerk rate out of speed into deceleration for Emergency Profile (Intermediate Speed 3 or Emergency Profile input).

LS45

Stop Jerk Emergency

Jerk rate out of deceleration into leveling speed and from leveling speed to zero speed for Emergency Profile (Intermediate Speed 3 or Emergency Profile input). Also, final jerk rate from leveling to zero speed for all runs.

LS47

Intermediate Speed 3
Correction

The amount of leveling distance to be eliminated from run at Intermediate Speed 3. Refer to parameter LS27 for further description.
Deceleration rate for Emergency Slowdown input function.

LS - Speed Profile Parameters

ESD and ETS Profile Rate Settings

LS48

ESD/ETS Deceleration

Deceleration rate for Emergency Slowdown (ESD) and Emergency Terminal Slowdown (ETS) input functions.

LS49

ESD/ETS Jerk

Deceleration Jerk rate for Emergency Slowdown (ESD) and Emergency Terminal Slowdown (ETS) input functions.

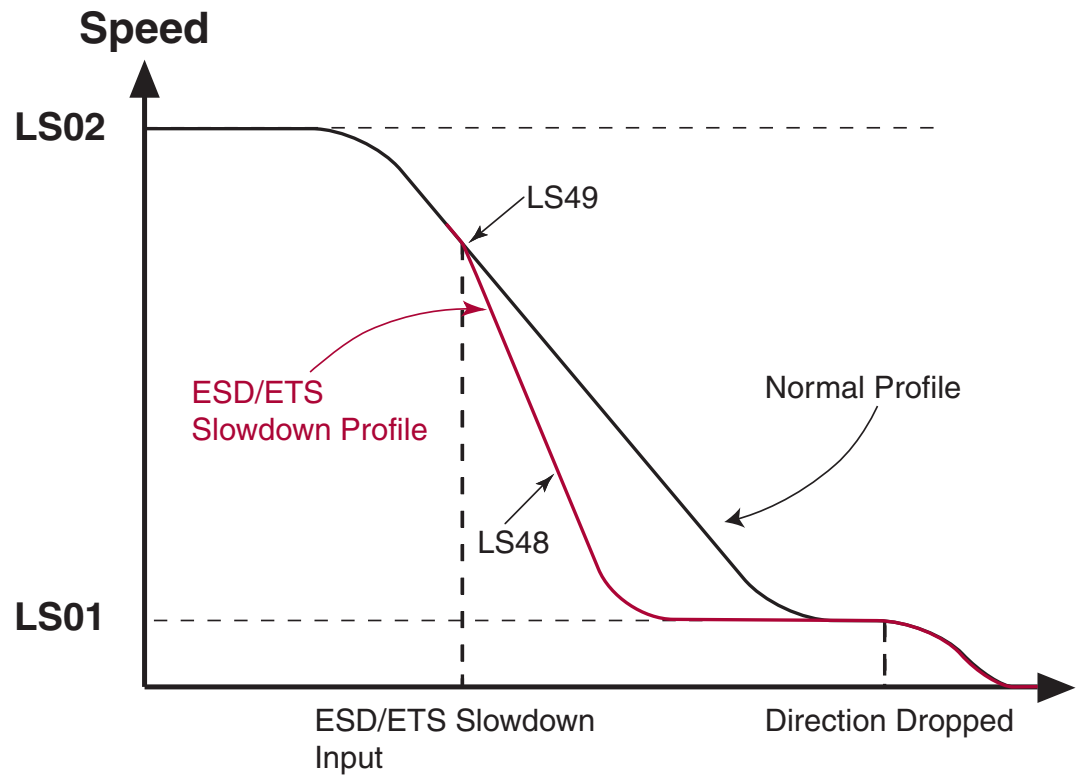

Inspection Speed Profile Rate Settings

LS50

Acceleration rate for Inspection Speed profile.

Acceleration Inspection

LS51

Start Jerk rate into acceleration for Inspection Speed.

Start Jerk Inspection

LS52

Acceleration Jerk rate into inspection speed for Inspection Profile.

Acceleration Jerk
Inspection

LS53

Deceleration rate for Inspection Speed profile. If the enable is dropped when the user releases the inspection switch, there will be no deceleration.

Deceleration
Inspection

LS54

Jerk rate out of inspection speed for Inspection Speed profile.

Deceleration Jerk
Inspection

LS55

Jerk rate out of deceleration into leveling speed and from leveling speed to zero speed for Inspection Speed profile.

Stop Jerk Inspection

LL - Tune Parameters

6.7 LL - Tune Parameters



For troubleshooting learn procedures, refer to Section 7.5

LL01

Motor Tuning

Auto tune of drive and motor characteristics. Refer to Section 5.9 for procedure.

LL02

Tuning Current

Percentage of rated motor current the drive will use when measuring the stator inductance of PM Synchronous motors. Lowering this value may decrease the amount of noise produced from the motor during this measurement. 50% is a good starting point.

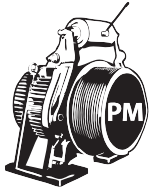

LL05

SPI

Stationary Pole Identification. Learns the motor pole position (encoder position) without movement, for synchronous motors. Refer to Section 5.10.1 for procedure.

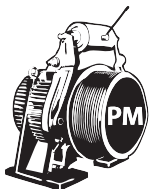

If the encoder A/B channel phasing is subsequently swapped in LE03, the SPI procedure will need to be performed again.

LL06

Encoder Pole Position Learn

Learns the motor pole position (encoder position) and encoder A/B channel phasing with movement, for synchronous motors. Method requires relatively frictionless load (unroped sheave or balanced car). Refer to 5.10.2 for procedure.

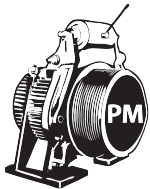

LL07

Encoder Synchronization

Determines correct phasing of A/B encoder channels and direction of rotation. Refer to Section 5.10.3 for procedure.

LL10

Inertia Learn

Learns the system inertia and activates the feed forward torque control (FFTC). Method should be performed with a balanced car. Learning the system inertia can provide better dynamic performance and a better ride quality with little or no adjustment of the speed control gains. Refer to Section 5.12.1 for procedure.

LL15

Overspeed Test

The Overspeed Test allows the drive to run at a speed higher than the programmed contract speed for a single run in order to perform overspeed or governor tests. The speed at which the Overspeed Test will operate to is set in LL16. The Overspeed test can also be used as the contract speed buffer test with digital or binary speed control.

LL16

Overspeed Test Speed

Maximum speed used during Overspeed Test in LL15.

LL17

Safety Release

The Safety Release function turns off the acceleration jerk rates and raises the maximum torque limit for one run in order to drive an elevator car off the safeties.

LL18

NTSD Tune Mode

The NTSD Tune Mode can be used to automatically determine and set the NTSD slowdown points.

When activated, run the elevator to either terminal floor. The motor speed when the NTSD switches are passed and the NTSD inputs are dropped will be learned during the run and displayed after the end of the run. There will also be the option to automatically set the TS03 - 08 Speed Thresholds for the corresponding NTSD input thresholds and direction of travel from the learn run. If values are automatically set from the learn run, the value entered will be 10% above the speed at which the input was dropped. After the learn run has been complete, the drive will return to normal operation.

LC - Control Setting Parameters

6.8 LC - Control Setting Parameters

LC01

Control Mode

The Control Mode determines whether the drive runs in open or closed-loop operation and the type of pre-torque control.

Default: Closed Loop FOC

Setting:	Description:	NUM
Open Loop V/Hz	Open loop in Volts per Hertz operation (induction motors only).	0
Open Loop Vector	Open loop operation , with sensorless motor management (induction motors only); Slip compensation and autoboot active are active as well as stationary hold at the end of run.	1
Closed Loop FOC	Closed-loop operation with field oriented control and internal pretorque to eliminate rollback at brake release without use of load weigher. Refer to Section 5.12.2 for additional adjustment information.	2
Closed Loop Analog Pretorque	Closed-loop operation with field oriented control and external pretorque input signal via AN2+ and AN2- for use with analog load weighing device. Refer to LC05 and LC10 parameter descriptions for notes regarding adjustment of external pretorque speed gain settings.	3
Closed Loop Digital Pretorque	Closed-loop operation with field oriented control and a fixed pretorque value to eliminate rollback without use of load weigher. Uses a fixed pretorque value LC34	4
Closed Loop Synth. Pretorque	Closed-loop operation with field oriented control and internal, predictive pretorque to eliminate rollback without use of load weigher. Refer to Section 5.12.2 for additional adjustment information.	5
Default = Closed Loop FOC (2)		



When using induction motors, the drive may be run open loop on inspection to verify whether the encoder functions normally. By setting the parameter LC01 Motor Control = Open Loop V/Hz, the inverter runs the motor open loop. The encoder feedback (motor speed) is displayed in Diagnostics Screen #2 or parameter DG07 Motor Speed, but has no effect on the operation of the motor. Therefore, this mode can be used to verify whether the encoder is functioning properly. Generally, when running empty car up the actual motor speed in should be equal to the set speed. If these values are off by more than 20 rpm when running empty car up, there is most likely an encoder or encoder cable problem.

Running an induction motor in open loop can also be used to rule out any issues when troubleshooting due to encoder feedback, motor data settings, and speed control settings. The only parameter available for adjustment in open loop V/Hz mode is LC32 Low Speed Torque Boost.

When using permanent magnet synchronous motors only closed loop operation is permitted.



Running V/Hz mode at high speed or leveling speed can result in high motor currents and or poor performance. Always verify that this parameter is set correctly before running in automatic mode!

LC - Control Setting Parameters

LC02

Speed Gain Optimization

If the inertia learn procedure has taken place, then the Speed Gain Optimization provides a quick adjustment of the speed control response on scale between 0 = 'Soft' and 25 = 'Hard'. From the learned inertia value, the drive determines a ratio between the proportional and integral gain and adjustment of the optimization will scale each accordingly.



The system inertia must be learned for the Speed Gain Optimization to be implemented. Optimization will lower the KI gain. For reference a value of 10 in LC02 normalizes the Kp value to 3000. So if LC02 = 10, the Kp gain goes to 3,000 and the KI gain drops to what is calculated. This is the best starting point. Refer to section 5.12.1 for learning the system inertia.



In most cases, the default settings for the Proportional and Integral speed control gains should provide a very good starting point for proper operation and ride quality. If adjustment is needed, it would be suggested to perform the Inertia Learn (Section 5.12.1) procedure, which can improve performance with little or no further adjustment to the Proportional and Integral speed control gains.

Proportional Gain



The proportional gain maintains general control and stability over the entire speed range. The proportional gain is split into three values: one for acceleration and constant speed, (LC03), one for deceleration and leveling (LC04) and one for pre-torque (LC05). Additionally, the value can be made speed dependent to automatically increase/reduce (LC25) with speed. Adjustments are also available for resonant frequencies (LC20-24).

When control mode is selected for open loop vector (LC01 Control Mode = (1); Open Loop Vector), these gains will be reduced to a very low setting. It is recommended not to change the value for proportional or integral gains after open loop vector has been selected. If close loop is selected again (LC01 Control Mode = (2) Closed Loop FOC), the gain values will need to be raised again (Proportional = 3,000 and Integral = 250).

Lower values (less than 1000) may result in loose control and overshoot of the command speed as high speed is reached. High values can cause high frequency oscillation resulting in vibration or a buzzing sound in the motor. If tighter control is necessary, the corresponding proportional gain can be raised accordingly.

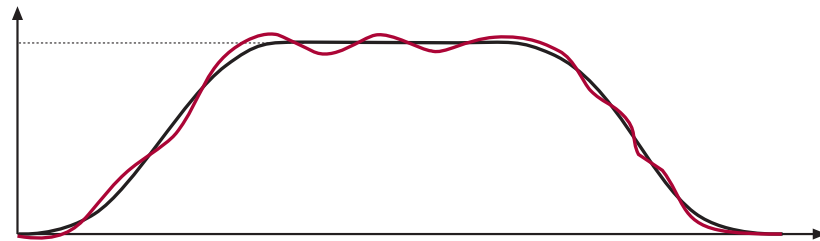

Proportional Gain Too Low (500) - Poor Control

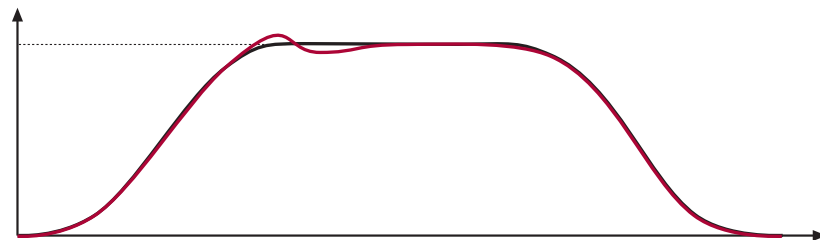

Proportional Gain Low at High Speed (1000) - High Speed Overshoot

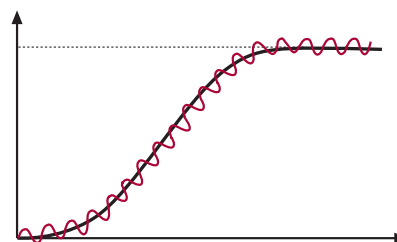

Proportional Gain Too High (10,000) - Vibration/Noise

LC - Control Setting Parameters

LC03 Proportional speed control gain during acceleration and high speed.

KP Speed Acceleration

LC04 Proportional speed control gain during deceleration and low speed.

KP Speed Deceleration

LC05 Proportional speed control gain for pre-torque.

KP Speed Pretorque

In most cases it is not necessary to adjust the proportional gain. However, if a vibration is felt in the car during the pre-torque phase this gain can influence it. Try values of 500, 1000, 4000, and 6000 to determine whether or not there is any influence. In cases, a higher value may actual provide a more smooth response.

Refer to Section 12.2 for additional information regarding pretorque.

When LC01 Control Mode = Closed Loop Analog Pretorque (3), this value should be set to 100.

Integral Gain



The integral gain is responsible for correcting long term average error in speed as well as providing increased control and rigidity at lower speeds for starting and stopping. The integral gain is split into three values one for acceleration and constant speed (LC08), one for deceleration and leveling (LC09) and one for pre-torque (LC10). Additionally, an offset to the integral gain value is adjustable if it is necessary to have a higher gain values to overcome starting friction as well as maintain good control at low speeds for starting (LC11) and stopping (LC12). The total integral gain value is the sum of integral and offset and the low speed range over which the offset is ramped up and active is adjustable (LC13-16) for both acceleration (LC13-14) and deceleration (LC15-16).

If this value becomes too high, it can result in torque pulsations during acceleration, deceleration, or at sustained speed. If the value becomes too low, the tracking of the command speed will suffer and the system may not catch the load quickly or overcome starting friction at takeoff, may take additional time to reach contract speed, or cause spotting during a dynamic jerk into leveling speed.

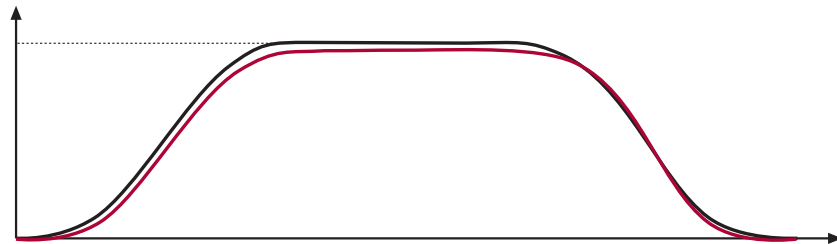

Integral Gain Too Low (100) - Speed Lags Command

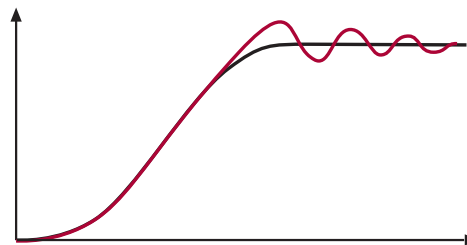

Integral Gain High at High Speed (1500) - Ringing after overshoot into high speed before speed settles.

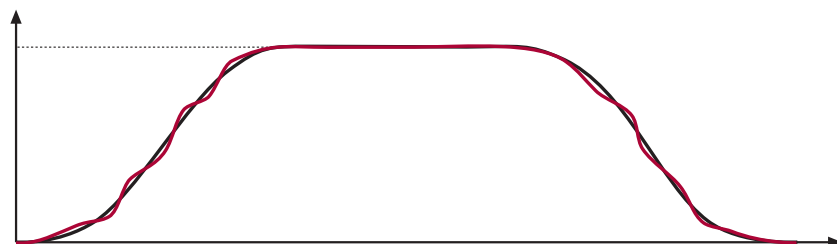

Integral Gain High (1500) - Jerk acceleration, bunching or spotting during deceleration

LC - Control Setting Parameters

LC08

Integral speed control gain during acceleration and high speed.

KI Speed Acceleration

LC09

Integral speed control gain during deceleration and low speed.

KI Speed Deceleration

LC10

Integral speed control gain for pre-torque.

KI Speed Pretorque

The pre-torque gain setting controls the rate of the build of torque and the stiffness of the motor as the brake releases. This gain can be adjusted to control the strength of the pre-torque. In general lower spring tension and lower brake pick voltages result in a smoother transition of the load from brake to motor. This gain should be adjusted as high as necessary to prevent the sheave from moving during break release. Typical values are between 5,000 and 20,000. If the value gets too high, vibration or audible noise in the motor may occur during the pre-torque phase.

Refer to Section 5.12.2 for additional information regarding pretorque.

When LC01 Control Mode = Closed Loop Analog Pretorque (3), this value should be set to 200.

Integral Offset Gain



The integral offset gain value is effective only at low speeds. This value is added to the integral term gain in LC08 for acceleration and LC09 for deceleration, to provide greater control and more stability.

During acceleration the offset gain value is tapered off beginning at defined corner speed and the offset reaches zero at the other where only the integral itself is active. The corner speeds can be adjusted through parameters LC13 and LC14 for acceleration.

During deceleration the offset gain begins to increase at one corner speed and is fully added to the integral at the other. The corner speeds can be adjusted through parameters LC15 and LC16 for deceleration.

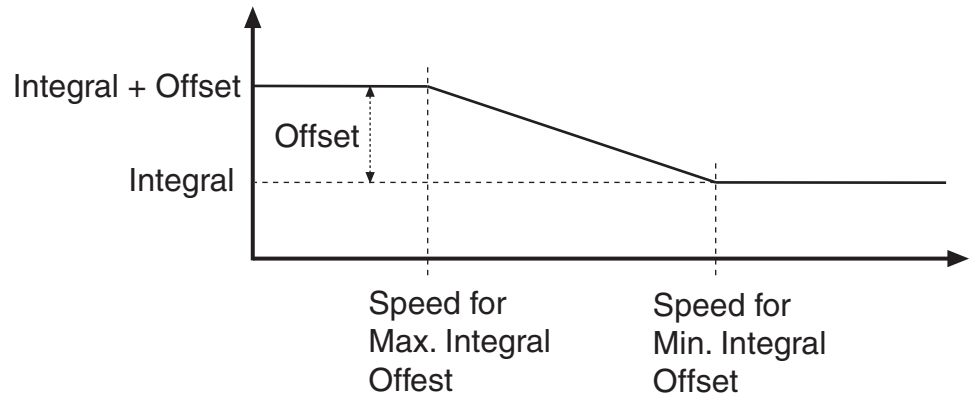

The LC15-16 corner speeds can be used to tailor the KI Offset gain to a specific speed range at low speed. Worm gear applications require a smaller KI Offset value but over a broader speed range, whereas a gearless motor will require a much higher KI Offset value but at only the very lowest speed. With these two parameters the Offset can be tailored to the application. The default values are applicable to worm gear applications.

LC - Control Setting Parameters

LC11

The integral offset gain for acceleration.

KI Offset Acceleration

This offset acceleration gain will assist the motor in catching the load during starting. It is especially important for high efficiency geared or gearless applications. Values of 2,000 to 5,000 are useful.

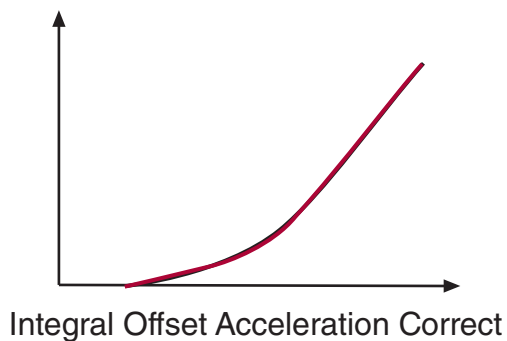

Integral Offset Acceleration Correct

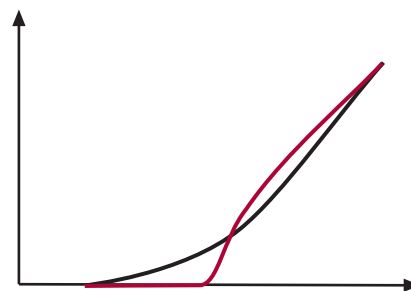

Integral Offset Acceleration Too Low (500) - Speed lags command on take off

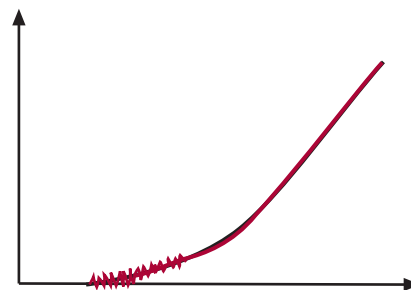

Integral Offset Acceleration Too High (6000) - Vibration at take off

LC12

The integral offset gain for deceleration.

KI Offset Deceleration

The offset deceleration gain will allow the system track the command speed tightly at low speed. Often lower values are required than for starting. Values of 500 to 2,000 are useful.

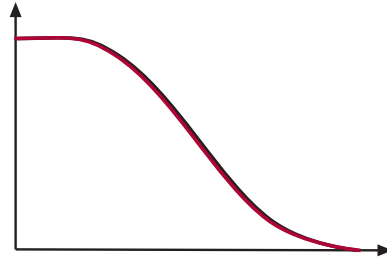

Integral Offset Deceleration Correct

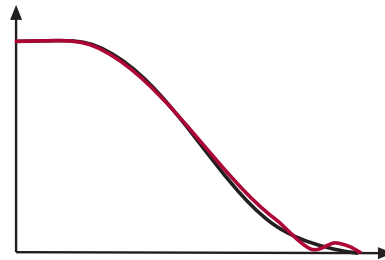

Integral Offset Deceleration Too Low (500) - Speed lags command during final transition into leveling speed. Speed may appear to spot or stop briefly just before stop; may undershoot floor.

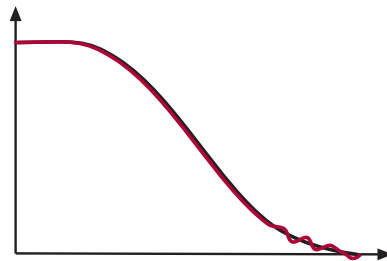

Integral Offset Deceleration Too High (5000) - Bunching or steps at final approach

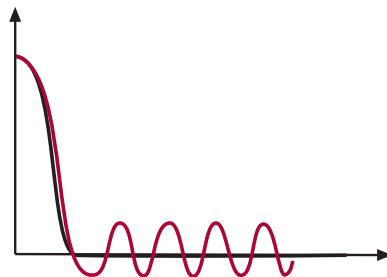

Integral Offset Deceleration Too High (5000) during leveling - Bouncing feeling during sustained leveling.

LC - Control Setting Parameters

Integral Offset Gain Corner Speeds

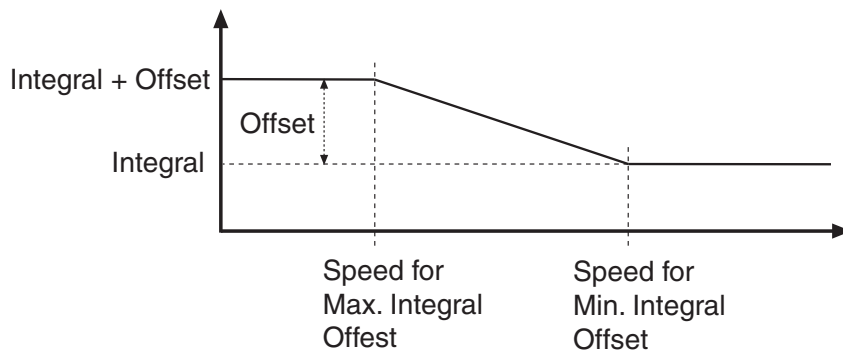

LC13

Speed for Max. KI
Acceleration

Corner speed below which the acceleration integral offset (LC11) is fully added to the acceleration integral term (LC08). Above this speed, the total integral gain tapered off to only the integral term at the speed defined in LC14.

LC14

Speed for Min. KI
Acceleration

Corner speed at which only the acceleration integral gain is active (no acceleration integral offset added).

LC15

Speed for Max. KI
Deceleration

Corner speed below which the deceleration integral offset (LC12) is fully added to the deceleration integral term (LC09). Above this speed, the total integral gain tapered off to only the integral term at the speed defined in LC16.

LC16

Speed for Min. KI
Deceleration

Corner speed at which only the deceleration integral gain is active (no acceleration integral offset added).

In the case where the speed begins to lag during the deceleration but then recovers in the final approach, it may be necessary to raise the corner speed of the start of the integral offset to a higher value. This may be useful for gearless applications.

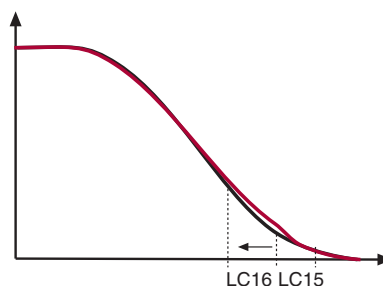

Speed for Min. Integral Offset Deceleration too low for gearless - Speed begins to lag during deceleration but then recovers in the final approach.

LC20

Selection of gain profile for the proportional speed control gain.

Gain Profile Mode

Default Setting: Variable

Setting:	Description:	NUM
Variable	The KP speed gain is constant according to corresponding acceleration and deceleration settings (Typical) .	0
Resonant	For PM motors which may exhibit a torque ripple at a resonant frequency or for elevators which may have unresolved resonant rope issues, the proportional speed gain control features adjustment to increase/decrease the speed gains around a given speed/frequency. See parameter LC.21 – 24 for further information.	1
Default = Variable (0)		

LC21

Percentage increase or decrease of the proportional speed gain at the resonant speed defined in LC22 during acceleration.

KP Speed Resonance
Acceleration

LC22

Speed at which the increase or decrease of the resonant proportional gain in LC21 fully effective.

Speed at Resonance
Acceleration

LC23

Percentage increase or decrease of the proportional speed gain at the resonant speed defined in LC24 during deceleration.

KP Speed Resonance
Deceleration

LC24

Speed at which the increase or decrease of the resonant proportional gain in LC23 fully effective.

Speed at Resonance
Deceleration

LC - Control Setting Parameters

LC25

KP High Speed

Percentage increase or decrease of the proportional gain at high speed after the point of resonance has been passed. In some cases it is beneficial to reduce the gain at high speed to minimize system response to hoistway vibrations or disturbances. When set to 100%, this function is effectively off.

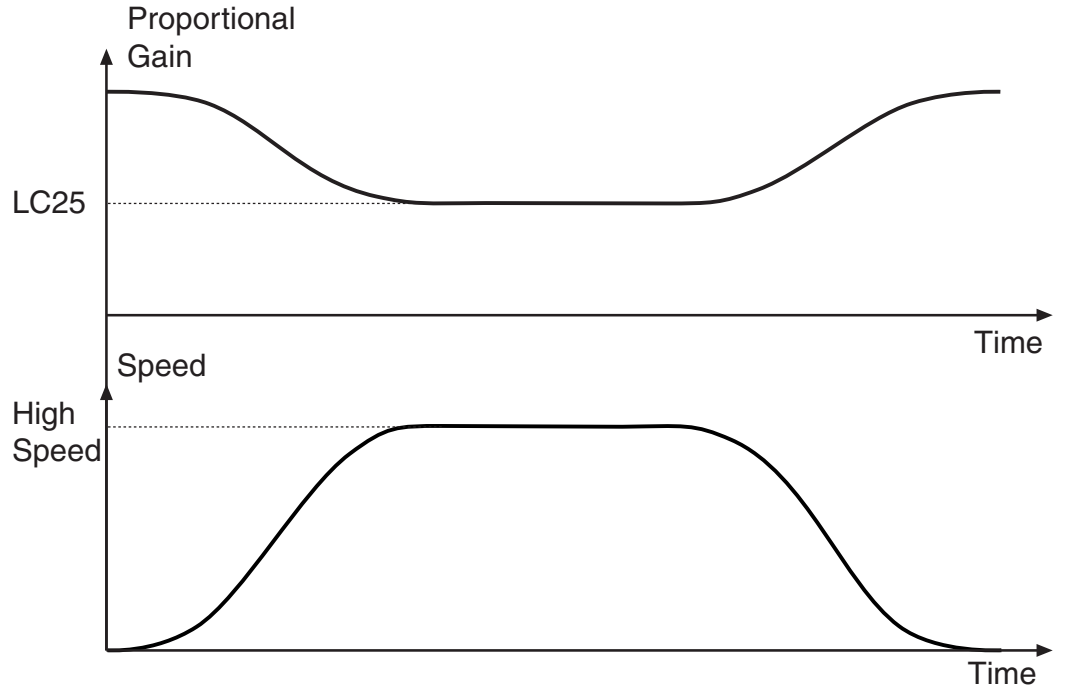

LC30

Maximum Torque

The maximum torque setting is used to limit the output current. For induction motors, the limit prevents the motor from exceeding its breakdown torque limit.

If the maximum torque setting is reached, the corresponding output current will be limited which may cause the acceleration process will take longer or stall with a full load or may also cause the car to overshoot the floor during deceleration.

Default Setting: 150%

The maximum output current is then limited to the following:

$$\text{Max. Current} = \frac{\text{LC30 Maximum Torque}}{\text{LM07 Motor Torque}} \times \text{LM03 Motor Current}$$



The maximum output current is ultimately limited to the drive's peak current rating, regardless of high the LC30 Maximum Torque may be set. Refer to Sections 2.4 and 2.5 for ratings.



The low default setting is to protect the motor from excessively high current which may occur during the commissioning process if there are incorrect parameter settings (e.g. motor data incorrect, encoder A/B phasing or ppr incorrect, encoder position for PM synchronous motor incorrect, etc.). The default setting should be sufficient to enable inspection operation with empty car. Under normal high speed operation, this value will likely need to be increased, typically in the range of 200-250% of rated motor torque.

LC31

Reduced Maximum Torque

The reduced maximum torque during is activated according to an input assigned for this function. This allows the drive to limit the torque and therefore the output current to prevent the drive from drawing too much current from a battery back up supply.

Default Setting: 100%

LC - Control Setting Parameters

LC32

Low Speed Torque Boost

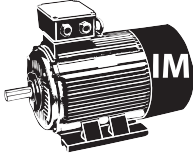

Adjusts the torque boost **only during open loop operation** (LC01 Control Mode = Open Loop V/Hz or Open Loop Vector). If the torque boost is too low the motor may not be able to lift the load. Too much boost can lead to high current while running open loop.

Default Setting: 5.0 %

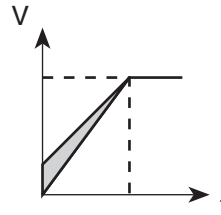

LC33

Auto Boost Gain

If open loop vector is selected, set to 1.00. If oscillations or vibrations are felt, reduce in steps of 0.1 (1.0 --> 0.9 --> 0.8 etc.).

LC34

Digital Pretorque

This parameter provides a fixed pre-torque value and can compensate roll back at one load condition (i.e. empty car). This can be used when no load weigher is present.

LC40

Acceleration Torque

The acceleration torque is used to calculate the system inertia. By entering a torque value in this parameter, the corresponding inertia is calculated from the mechanical data in LN01...LN03. The acceleration rate is an internal value of 1.5ft/s^2 and is not adjustable. The resulting inertia value is loaded into LC41 System Inertia and the feed forward torque control is turned on.

The torque value can be learned by using the LL10 Inertia Learn. The value is the acceleration torque minus the torque while running at contract speed. The LL10 Inertia Learn procedure will automatically determine this value. A balanced car is required for this procedure. Refer to Section 5.12.1 for the Inertia Learn process.

LC41

System Inertia

The total system inertia, motor and load. Refer to section 5.12.1 on the Inertia Learn process.

When the system inertia has been entered, settings for the FFTC feed forward torque command (LC42-43) will be calibrated according to the control mode.



If activating the System Inertia and FFTC introduces vibration during the acceleration or deceleration, it may be necessary to increase the LC42 Feed Forward Torque Command Filter by one step (eg. 31 to 16 Hz), For externally generated speed profiles (serial, analog), this may help filter the steps in the pattern. Increasing the filter further may introduce unwanted delayed response.

It may be necessary when using FFTC to lower the value of KI and KI Offset (LC8-9, 11-12) speed gains (by a factor of 5-10).

Another option is to use the LC02 Speed Gain Optimization after the System Inertia has been learn. The Speed Gain Optimization allows for adjustment of the speed control gains on a sliding scale (e.g. 0 = Soft, 25 = Hard) which automatically adjusts the Proportional and Integral Speed Control gains (but not the Integral Offset).

LC - Control Setting Parameters

LC42

Feed Forward Torque
Command Filter

This provides a low pass filter to the speed command. When the system inertia has been entered, this setting will be calibrated according to the control mode.

In control modes where the speed profile is generated by the controller (serial, analog), decreasing the frequency (increasing sample time) may help reduce any unwanted affects from discontinuous inflection points in the speed profile generated by the controller.

Settings:	NUM
Off	0
250 Hz (4 ms)	1
125 Hz (8 ms)	2
63 Hz (16 ms)	3
31 Hz (32 ms)	4
16Hz (64 ms)	5
8.0 Hz (128 ms)	6
4.0 Hz (256 ms)	7
2.0 Hz (512 ms)	8
1.0 Hz (1024 ms)	9
Default = Off (0)	

LC43

Feed Forward Torque
Command Gain

Determines the relative gain of the feed forward torque command. 100% = unity command. A value of 90% is recommend. Higher values strengthen the response, lower values weaken the response. When the system inertia has been entered, this setting will be calibrated.

LC44

Torque Command Filter

Provides a low pass filter on the torque command signal before it is fed into the current control. Lower values can be used to eliminate audible harmonic sounds which may be heard in the motor.

Settings:	NUM
Off	0
2000 Hz (0.5 ms)	1
1000 Hz (1 ms)	2
500 Hz (2 ms)	3
250 Hz (4 ms)	4
125Hz (8 ms)	5
63 Hz (16 ms)	6
31 Hz (32 ms)	7
Default = Off (0)	

6.9 LT - Timer Parameters

LT01

Brake Release Delay

This time delays the release on the brake when one of the outputs is assigned as Brake Control and that output is used to trigger the brake release.

The LT01 Brake Release Delay timer begins after the Drive Enable and Direction commands have been given and the current check has completed.

The Brake Control and Drive On outputs will be active after the expiration of the TL01 Brake Release Delay time.

LT02

Control Hold Off

The amount of time after a run command has been given that the drive will maintain very low speed control gains in order to prevent any reaction to movement or encoder disturbance while the brake is still set. If used, the timer must be set to expire before the brake picks.

The LT02 Control Hold Off timer begins after the Drive Enable and Direction commands have been given. The total time the Control Hold Off is active is LT01 + LT02.

LT03

Speed Start Delay

The amount of time the drive will hold the speed command at zero. This time delay allows the brake to release before the motor starts turning. This parameter applies to control modes US04 Control Type = Binary Speed Selection (1), Digital Speed Selection (0), or Serial Binary Speed DIN66019 Serv.50 (6).

For control Modes US04 Control Type = Bi-Polar Analog Speed (3), Absolute Analog Speed (2), Serial Speed DIN66019 Service 49 (4), Serial Speed DIN66019 Service 50 (5), the profile delay is controlled externally by the controller and the drive will not clamp the value at zero speed during this period.

The LT03 Speed Start Delay timer begins after the Drive Enable and Direction commands have been given, current check has completed, and the LT01 Brake Release Delay timer has expired.

LT - Timer Parameters

LT10

Brake Drop Delay

This time delays the drop of the brake when one of the outputs is assigned as Brake Control and that output is actually used to control the brake.

The LT10 Brake Drop Delay timer begins after the Direction input has been dropped and the speed command has reached zero speed.

The Brake Control output will turn off when the Brake Drop Delay time has expired.

LT12

Current Hold Time

This parameter determines how long the drive will maintain full current and control of the motor after the direction inputs have been turned off. During this time, motor current will continue to flow (however the analog input will be clamped and the speed control gains will be reduced) to allow the motor hold zero speed until the brake has set. This time should be adjusted longer than the actual required time for the brake to mechanically drop.

The LT12 Current Hold Timer begins after the Direction input has been dropped, the speed command has reached zero speed, and the LT10 Brake Drop Delay timer has expired.

The Drive On output will turn off when the LT12 Current Hold Time has expired.

LT13

Current Ramp Down Time

Once the time in LT12 Current Hold Time has expired, current will continue flowing to the motor, but the drive will ramp the motor torque down to zero over the time adjusted in LT13 Current Ramp Down Time. This provides a smooth transition of the load to the brake and a quiet de-energization of the motor. This time should be adjusted such that the drive shuts off the current before the controller drops the drive enable (I7) and opens the motor contactor. If the drive enable is dropped before the current is shut off, it is possible the drive will respond with base block protection “BBL” which can prevent further operation for 1 to 3 seconds, depending on the drive size; likewise, a Drive Enable Dropped event may be logged. Therefore the times should be adjusted to prevent this. Additionally during this time the speed control is turned off to prevent the motor from driving against the brake.

The LT13 Current Ramp Down Time begins after the Direction input has been dropped, the speed command has reached zero speed, the LT10 Brake Drop Delay timer has expired, and the LT12 Current Hold Time has expired.



The total time between the drop of the direction signals and the turn off of motor current is $LT10 + LT12 + LT13$. The time delay for dropping the enable (I7) and the opening of the motor contact should be greater than this sum. If the enable is dropped prematurely, then current will be cut off immediately and this may be felt as a ‘clunk’ in the motor.

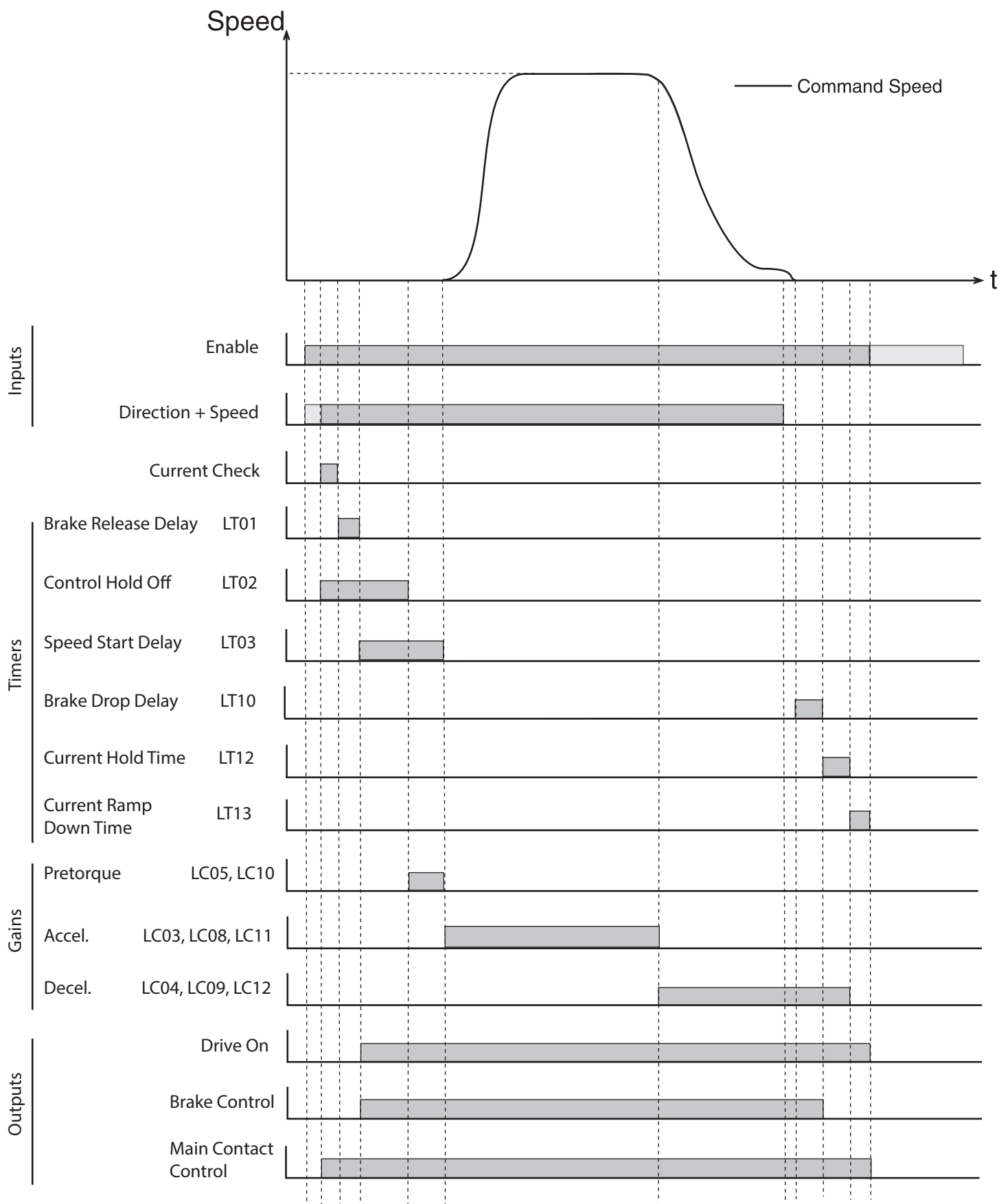

LP - Positioning Parameters

6.10 LP - Positioning Parameters

These parameters are used to configure the position controller in the drive. In order to use this function, the elevator control must be designed to give the proper signal sequence ensuring correct operation.



The general restrictions for using positioning control are as follows:

- The US04 Control Type must be set for Binary or Digital Speed Selection.
- There must be an encoder on the motor and that encoder must be connected to interface X3A.



- Before each run at high speed the drive must be disabled and re-enabled to reset the position control.
- Re-leveling can occur at the end of the run without dropping the enable signal.

Principle of operation:

When LP01 Positioning Control = Posi One Floor and high speed is selected at the beginning of the run, the drive enters positioning active (PA) mode and starts to accelerate the car up to high speed. When the car passes the slowdown sensor in the hoist way, the controller turns off the high speed command to the drive. At this moment the drive recognizes that the car is at the learned LP03 High Speed Slowdown Distance and then proceeds to create a slowdown profile to bring the car to leveling speed.

If the car is running at high speed, the drive simply calculates the deceleration profile based on the adjusted values in LS23, LS24 and LS25, and then decelerates the car accordingly down to leveling speed. Once at leveling speed, the elevator runs until floor level is reached and then the leveling speed and direction are turned off causing the elevator to stop.

If the car is still accelerating (<80% contract speed) when the slowdown is reached (e.g. one floor run), the drive realizes this and calculates a profile to continue the acceleration, up to the maximum high speed and then proceeds to decelerate the elevator down to leveling speed.

Similar to high speed operation, Intermediate Speed 1 can be used as a reduced, short floor speed and will have a corresponding LP04 Short Floor Slowdown Distance and will follow the deceleration profile in LS33, LS34 and LS35.

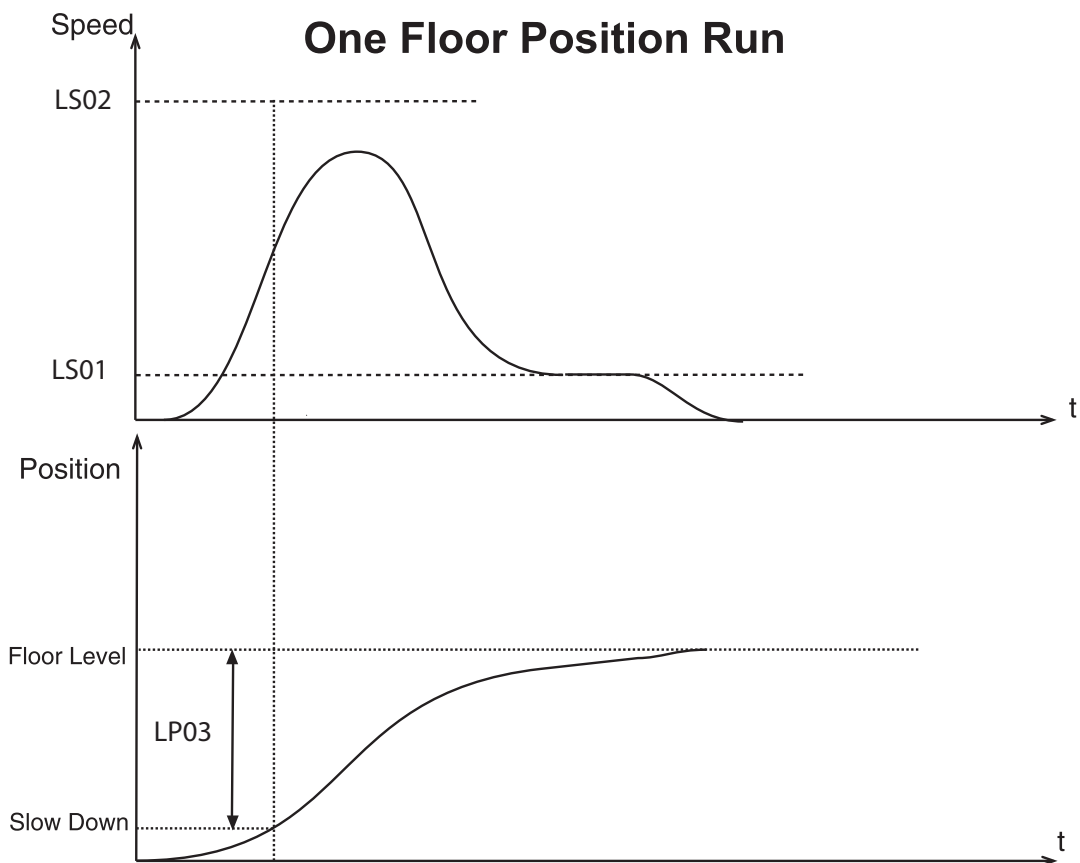
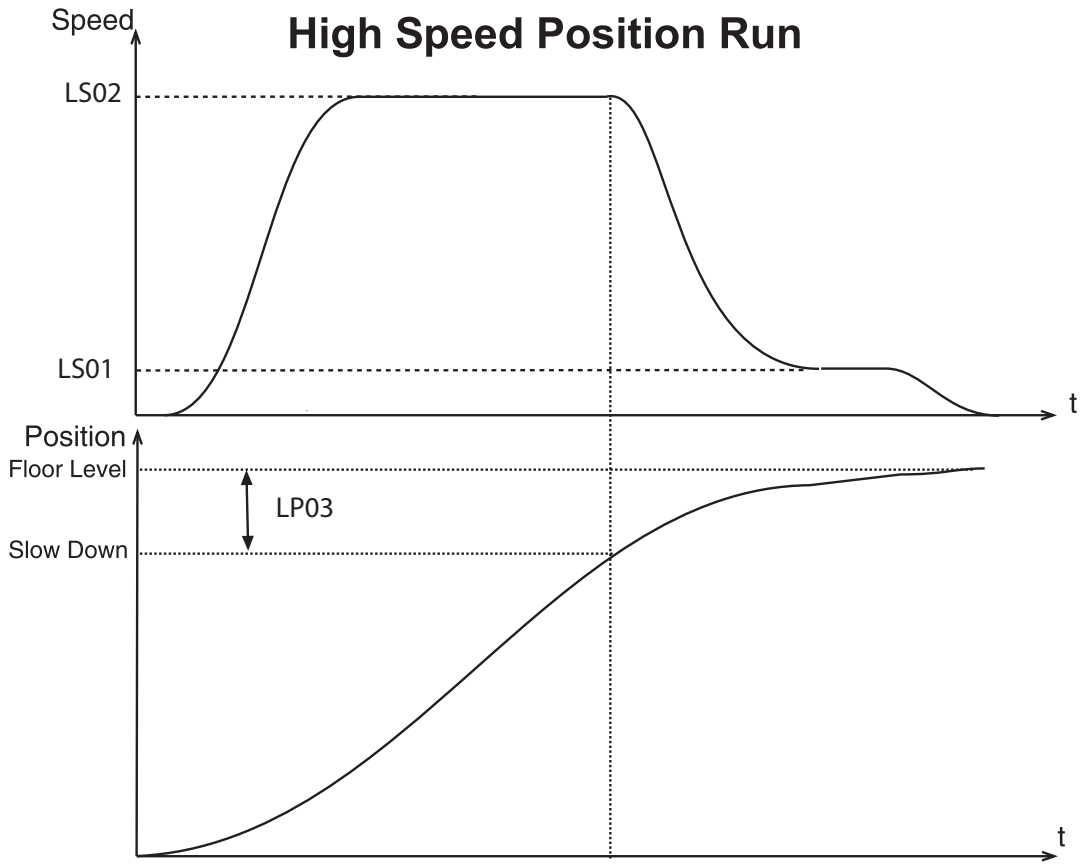

LP - Positioning Parameters

Learning the Slowdown Distance:

The actual slow down distance can be learned by the drive or it can be entered manually. However, it is recommended that the drive actually learn the distance as this will also take into account the internal delays of the controller. These delays will actually result in a lower value for the slowdown distance than that actually measured with a tape measure.

First verify that the value in LP02 Minimum Slowdown Distance is at least 6-8 inches lower than the actual slowdown distance as measured in the hoist-way with a tape measure. This distance reduction accounts for the delay in the controller. If the LP02 Minimum Slowdown Distance is too high, adjust the profile in parameters LS23, LS24, LS25 to achieve a lower value. Note: after changing the profile parameters, the LP02 Minimum Slowdown Distance will automatically re-calculate.

Now it is possible to learn the slow down distance.

- 1) Move the car on inspection to a floor in the middle of the hoist-way.
- 2) Adjust LP01 Position Control = Learn Slowdown.
- 3) Place a call up or down for a High Speed (if necessary, multi-floor) or Short Floor run.
- 4) At the moment the slowdown is crossed, the drive begins measuring the slowdown distance.
- 5) Once the car comes to a stop and the drive is disabled, the drive will note the actual position, subtract a portion and then load the value into parameter LP03 High Speed Slowdown Distance or LP04 Short Floor Slowdown Distance, depending on the speed that was selected for the run. At this point the distance has been learned and LP01 will automatically be set to 'Posi One Floor', activating positioning. The slowdown distance should be learned for both a High Speed and Short Floor runs.
- 6) To verify distance, set the display to Home Screen. Place a call up or down for a 1 floor run. The Inverter Status should show 'Positioning Active' while the car runs to the floor all the way down to leveling speed, indicating the positioning is functioning normally. Now the LP05 Correction distance can be manually adjusted to minimize the leveling distance. Additionally the profile can be further adjusted if needed for ride comfort. Repeat the process for high speed run adjusting the LP03 High Speed Slowdown distance to adjust the leveling distance in this case.
- 7) If the Inverter Status or Fault Log indicates 'Position Not Accessible', the drive will attempt to increase the deceleration and jerks in an attempt to

prevent overshooting the floor. If the car under- or overshoots the floor, the position is not accessible. Increase the rate of deceleration and/or jerk and then re-learn the position. If this still does not resolve the problem, it may be necessary to move the slowdown point further away from the floor.

LP - Positioning Parameters

LP01

Position Control

This parameter is used to turn on the One Floor Positioning Control functionality or to learn the high speed and short floor slowdown distances.

When set to Learn Slowdown, the slowdown for the selected speed (high speed or short floor) will be measured on the next run. Afterwards, LP01 will automatically be set for positioning turned on.

LP02

Minimum Slowdown
Distance

This parameter shows the minimum required slow down distance, based on the adjusted profile (acceleration, jerks, high speed) to slow down from contract speed.

LP03

High Speed Slowdown
Distance

This value is the actual distance the drive uses to calculate the actual deceleration profile for High Speed runs.

LP04

Short Floor Slowdown
Distance

This value is the actual distance the drive uses to calculate the actual deceleration profile for short floor runs

LP05

Correction Distance

The corrective distance can be used to reset the position error as the car comes to the floor. When the drive sees the leveling zone marker, the position counter is reset to reflect the actual distance entered in this parameter. The controller passes the leveling zone sensor signal to the drive via an input programmed as 'Position Deviation Reset'. Refer to input parameters LI04-11 for further information programmable input functions.

With this parameter the amount of stabilized leveling can be adjusted. A value of zero means no correction, the function is off and the leveling distance is the distance adjusted in the controller.

A value of 6.0", the distance of the leveling zone to the dead zone, will provide no leveling and the system will be on the verge of over shooting the floor.

The optimum adjustment for direction to the floor operation is a value of 5.7"...5.9". If a little leveling is desired set the value to 5.0"...5.5".

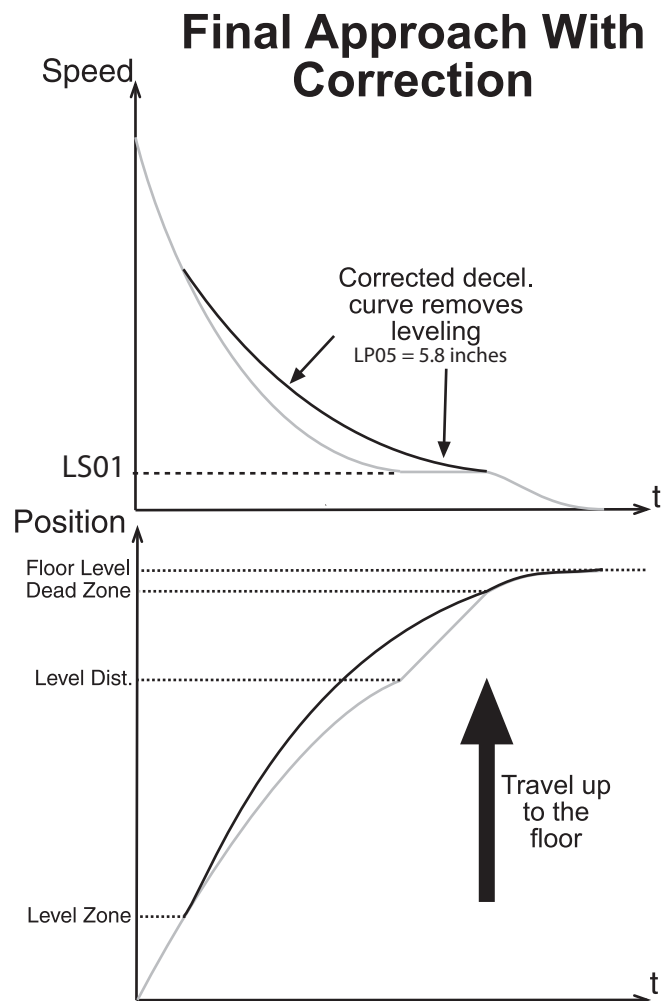

LP - Positioning Parameters

LP07 - 08: Position Count Scaling

Parameters LP06, LP07, LP08 provide a means independent from parameters US06, LN21, LN22, LN23 to adjust the scaling of inches into counts on the motor encoder. The scaling is defined by the following relationship:

$$\text{counts/inch} = (\text{LP06} \times 10000 + \text{LP07}) / \text{LP08}$$

Initially these values are calculated from the values entered into parameters LN21, LN22, LN23, LE02, and LE05. After adjusting these parameters, it is possible to change the values in LP06, LP07, LP08. Keep in mind that any changes made to the LN parameters LN21, LN22, LN23 or LE parameters LE02 or LE05 will force LP06, LP07, LP08 to recalculate

LP06

Scaling Increments
High

LP07

Scaling Increments
Low

LP08

Scaling Distance

6.11 LX - Special Functions Parameters

LX01

Auto Reset

With LX01 Auto Reset, all drive faults, except 'Error Encoder Interface' faults, can be automatically reset.

The number adjusted in this parameter determines how many times per hour the elevator drive will automatically reset faults. Before resetting the fault, the drive will wait 4 seconds to allow everything to stop or stabilize. It is not fault specific, so with the default setting of 5, if the drive experiences 6 different faults in one hour the unit will latch the last fault and not reset.



Note: Overload and overtemp faults are not reset until the overload counter resets or the temperature value drops to the reset level.

LX02

Switching Frequency

The switching frequency of the inverter can be set with this parameter. The switching frequency can be constantly 8 kHz or 16kHz, each with an automatic reduction based on the heat-sink temperature.

Settings:	NUM
8 kHz	0
12 kHz	1
16 kHz	2
Default = 16 kHz (2)	



If the display often shows the error message 'Error Overheat Power Module', then this parameter should be set to 8kHz. Some power stages may only support up to 8kHz. On these units it is not possible to change to this value to 16kHz.

LX06

Function Test

Since the drive's fans are thermostatically controlled, this parameter allows all fans to be turned on high to check their operation.

Settings:	NUM
Off	0
Fans On	1
Default = Off (0)	

LX - Special Function Parameters

LX08

Phase Current Check

This parameter can be used to select what type of current check is performed. If Phase Current Check is selected, the Magnetizing Current Check will also be performed for induction motors.

In the event there is a problem getting a consistently positive phase current check, the user will see 'Error Low Motor Current'. It is possible to select only a magnetizing current check but this setting should only be used on construction mode as the code requires a check of all phases before automatic operation.

The process is initiated at the beginning of a run with the drive enable and a direction input. The phase current check completes in approximately 300ms.

Settings:	NUM
Magnetizing Current Check	0
Phase Current Check	1
Default = Phase Current Check (1)	

LX09

Watchdog Time

This parameter adjusts the serial watchdog timer between the keypad and control card.



A setting of 0 or Off turns off the watchdog timer. This mode of operation is recommended for trouble shooting purposes only.

LX10

EdOH Function

This parameter can be used to activate the temperature sensor input (T1 and T2) on the drive. With this input activated, if the resistance between T1 and T2 becomes greater than 1650 ohms, the drive will trigger an 'Error Motor Overheat' fault indicating that the temperature sensor is too hot.

Setting:	Description:	NUM
Off	No function	0
On	After the sensor triggers, the drive will fault after modulation turns off at the end of the run or after a 120 second time delay, whichever occurs first.	1
Default = Off (0)		

LX11

Reference Splitting

This function creates a slope between two successive speed values which are transferred serially. This parameter should be adjusted for a time double the actual serial update rate of the speed command. The function smooths out the relative course steps which can occur during rapidly changing speed commands.

LX12

Baud Rate

This parameter sets the external serial communication baud rate at connector X6D (typically used for connection with Combivis). This communication port supports the DIN 66019 II standard.

Settings:	NUM
1200 bps	0
2400 bps	1
4800 bps	2
9600 bps	3
19200 bps	4
38400 bps	5
55500 bps	6
115200 bps	7
Default = 38400 bps (5)	

LX13

Speed Following Error

Triggers a drive warning/error if the actual motor speed deviates from the command speed by more than the window defined in parameter LX14.

This function only works in closed loop speed control mode (i.e. LC01 = Closed Loop FOC, Closed Loop Analog Pretorque, Closed Loop Digital Pretorque, Closed Loop Synthetic Pretorque).

Setting:	Description:	NUM
Warning - Digital Output	Speed following error drops output programmed as 'At Speed'. Warning is then to be handled externally to the drive.	0
On with Error	Speed following error drops 'At Speed' output and drive trips into error "Speed Following Error".	1
Default = On with Error (1)		



The time window for which the duration of LX14 Speed Difference must occur for the Speed Following Error occurs is fixed at 1.0 sec.

This window does not apply when an output is programmed as At Speed.

The function is also active during idle.

LX14

Speed Difference

Sets the +/- window for the speed following error in percent of the contract speed.

Default = 10%

LX - Special Function Parameters

LX15

Speed for Pre-Opening

When an output is programmed as Speed for Pre-opening, this parameter determines below what speed the output will activate to allow door pre-opening in the leveling zone.

Since this function is based on actual encoder speed, it only works in closed loop speed control mode (i.e. LC01 = Closed Loop FOC, Closed Loop Analog Pretorque, Closed Loop Digital Pretorque, Closed Loop Synthetic Pretorque).

LX16

Deceleration
Confirmation Speed

This parameter is used when an output is programmed as Deceleration Active. The parameter defines the speed threshold, below which a deceleration confirmation is given. It should be used when running at high speed.

LX17

ETS Speed

Emergency Terminal Slowdown (ETS) Speed corresponding to input programmed as ETS Speed (29)

Sets the speed limit the elevator must be under once the ETS switch is crossed. The ETS sensors, normally closed type, must be routed to an input on the drive. If the input turns off and the car speed is still above this value the drive will automatically trigger an emergency terminal slowdown using LS48-49 ESD/ETS Deceleration and Jerk rates. Refer to the ETS input function under LI04 for additional information.

LX18

Braking Resistance

The braking resistor value can be set which allows the drive to calculate the total energy dissipated by the resistor. A running total of the dissipated energy is measured in kWhrs and is stored in drive parameter DG42.

This provides the equipment owner an estimation of potential energy savings from line regeneration.

6.12 CH - Configuration Handling Parameters

The Configuration Handling parameter group has the same functions as US05 Load Configuration, which is only accessible with the OEM level password or higher.

CH01

Default Parameters

The drive can be reverted back to default settings. The default settings are customizable and may vary from those from KEB.

Setting:	Description:	NUM
Off	No action taken	0
Factory Reset	Will load defaults, as created by controller OEM	1

CH02

Save Parameters

All current parameter settings can be saved to flash memory on the keypad operator or onto an SD card (SD keypad operator only) for future access. Or, current keypad operator settings can be downloaded to the drive if a new or different keypad operator is installed. Saving to the flash or SD provides a 'backup point' during adjustment and allows a user to revert back to known settings.

Setting:	Description:	NUM
Off	No action taken	0
Save to Flash	All current parameter settings are saved to keypad operator flash memory	1
Save to Card	All current parameter settings are saved to SD card	2
Write to Drive	Current keypad operator settings downloaded to drive	3

CH03

Restore Parameters

Previously saved parameters can be restored from keypad operator flash memory or SD card (SD keypad operator only) in order to revert to previous settings. Or, current drive settings can be uploaded from the drive unto a new or different keypad operator.

Setting:	Description:	NUM
Off	No action taken	0
Restore from Flash	Previously saved parameter settings are restored from internal keypad operator flash	1
Restore from to Card	Previously saved parameter settings are restored from SD card	2
Restore from Drive	Current drive settings are uploaded from drive to keypad operator	3
Load Motor Data	Loads data from 'dw5' stored to flash.	4

CH - Configuration Handling

CH05 - 09: Configuration Wizard

A pre-determined parameter list can be selected based on the parameters CH05 Motor Type, CH06 Rope Ratio, CH07 Contract Speed and CH08 Car Capacity, then loaded with parameter CH09 Program the Selection = Program.

CH05

Motor Type

Name:	NUM
None Selected	0
Hollister-Whitney	
HW GL100-15L	1
HW GL100-15H	2
HW GL100-20L	3
HW GL100-20H	4
HW GL115-35L	5
HW GL115-35H	6
HW GL115-50L	7
HW GL115-50H	8
HW GL130-20L	9
HW GL130-20H	10
HW GL130-35L	11
HW GL130-35H	12
HW GL130A-20L	13
HW GL130A-20H	14
HW GL130A-40L	15
HW GL170-35L	16
HW GL170-35H	17
HW GL171-20L	18
HW GL171-35L	19
HW GL171-35H	20
HW GL185-50L	21
HW GL171-20H+HW GL185-50H+HW GL185-70L	22
HW GL171-40L+ HW GL260-35L	23
HW GL260-35H	24
HW GL260-50L	25
HW GL260-50H	26
HW GL260-70L	27
Imperial Electric	
IE 472	32
IE 475	33
IE 478	34

Name:	NUM
IE 478-LS	35
IE 522	36
IE 522LS	37
IE 525	38
IE 525LS	39
IE 805	40
IE 808	41
IE 808-HD	42
Torin Drive	
TD TGL1-3550	48
TD TGL1-3570	49
TD TGL1-3580	50
TD TGL2-3535-LV	51
TD TGL2-3535-HV	52
TD TGL2-3550-LV	53
TD TGL2-3550-HV	54
TD TGL2-3570-LV	55
TD TGL2-3570-HV	56
TD TGL2-5050	57
TD TGL2-5070	58
TD TGL2-5080	59
TD TGL3-8050	60
TD TGL3-8060	61
TD TGL3-8070	62
Prisma	
PR F03_AT/450	64
PR F03_BT/450	65
PR F04_AD/450	66
PR F04_AT/450	67
PR F04_BT/450	68
PR C-MAX_001/320	69
PR C-MAX_002/320	70
PR C-MAX_003/320	71
PR C-MAX_003/400	72
PR C-MAX_004/320	73
PR C-MAX_004/400	74
PR C-MAX_005/320	75
PR C-MAX_005/400	76
Default = None Selected (0)	

CH - Configuration Handling

CH06

Rope Ratio

Setting:	NUM
1:1	0
2:1	1
4:1	2
Default = 1:1 (0)	

CH07

Contract Speed

Setting:		NUM
ft/min	m/sec	
75	0.38	0
100	0.5	1
150	0.75	2
200	1.0	3
250	1.27	4
300	1.5	5
315	1.6	6
350	1.77	7
400	2.0	8
450	2.3	9
500	2.5	10
600	3.0	11
700	3.6	12
800	4.0	13
1000	5.0	14
Default = 75 ft/min (0)		

CH08

Car Capacity

Setting:		NUM
lbs	kg	
1000	480	0
1388	630	1
1500	680	2
2000	900	3
2200	1000	4
2500	1150	5
3000	1360	6
3500	1600	7
4000	1814	8
4400	2000	9
4500	2041	10
5000	2268	11
Default = 1000 lbs (0)		

CH09

Program the selection

Setting:	NUM
Off	0
Program	1
Default = Off (0)	

CH - Configuration Handling

CH10 - 15: LED Diagnostics

The LEDs on the serial operator are used to indicate operational status. In addition they can be used for troubleshooting or diagnostics.

For each LED, a parameter will select whether the LED has its normal function or is mapped to a special function. The tables below describe the function.

CH10 and CH13:

Value:	Function:	Description:
0	Default Normal Function	The standard function
1	Input Status	Bit 0-7 = I1 - I8 in Dg01
2	Output Status	Bit 0-3 of Dg11
3	Output Condition Status	Bit 0-7 of Dg16
4	Lift App Control Word	Bit 0-31
5	Inverter Control Word	Bit 0-15 of Sy50 (internal)
6	Field Bus Control Word	Bit 0-15 of Fb01
7	CAN Bus Control Word	Bit 0-15 of Fb43
8	Raw Memory Address	Bit 0-31 of the address and bit in CH12 and CH13

CH11, 12 and CH14, 15:

Para:	Value:	Function:	Description:
CH11 CH14	000000h - FFFFFFh	Memory Address	The address at which the memory will be evaluated
CH12 CH15	0h - 7h	Data Size and Bit	00h-07h = bits 0-7 byte sized data 10h-1Fh = bits 0-15 word sized data 20h-3Fh = bits 0-31 long sized data

CH10 Left LED Function	Defines the function of the left LCD keypad operator LED.
CH11 Left LED Address	The hexadecimal address of the corresponding parameter being mapped to the left LED.
CH12 Left LED Data Size / Bit Number	Selects the size of the data at the memory address and which bit is mapped to the left LED
CH13 Right LED Function	Defines the function of the right LCD keypad operator LED.
CH14 Right LED Address	The hexadecimal address of the corresponding parameter being mapped to the right LED.
CH15 Right LED Data Size / Bit Number	Selects the size of the data at the memory address and which bit is mapped to the right LED.

CH - Configuration Handling

Example:

Not available.

6.13 LA - Analog I/O Parameters

Analog Input 1



Settings LA01-07 for Analog Input 1 (AnIn1) correspond to terminal inputs AN1+ and AN1-.

LA01

Analog Input 1 Noise Filter

The noise filter suppresses disturbances and ripples of the analog input signals. If the noise filter is switched off the analog inputs are queried every 1 ms and the recorded value is then transferred. The noise filter adjustment specifies the time over which the data samples are averaged. This parameter is automatically adjusted when $LC40 > 0$.

LA04

Analog Input 1 Dead Band

Through capacitive as well as inductive coupling on the input lines or voltage fluctuations of the signal source, the motor connected to the inverter can still drift (tremble) during standstill in spite of the analog input filter. It is the task of the dead band, or zero-point hysteresis, to suppress this. With this parameter the respective analog signals can be faded out within a range of $0...±10\%$ ($0...1V$). The adjusted value is valid for positive and negative input signals. If a negative percent value is adjusted the hysteresis acts in addition to the zero point around the current setpoint. Setpoint changes are accepted only if they are larger than the adjusted hysteresis.

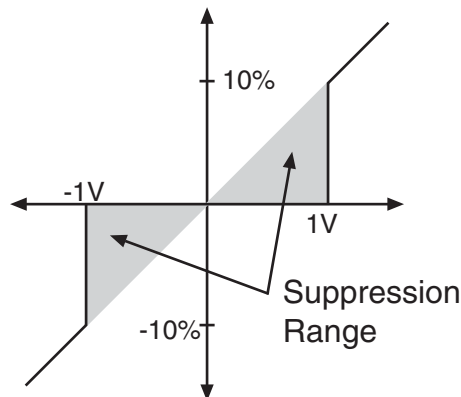

Example of 10% Dead Band

LA - Analog I/O Parameters

Analog Input 1 Scaling



With parameters LA5-07 or LA15-17, the corresponding analog input signals can be adapted in X and Y direction as well as in the gain. The input value corresponds to the applied analog voltage. The output value is what is processed by the drive, calculated according to following formula:

$$\text{Out} = \text{Amplification} \times (\text{In} - \text{X Offset}) + \text{Y Offset}$$

LA05

Analog Input 1 Gain

The analog pattern can be scaled directly through this parameter. As an example, if the analog signal is +/- 0...5 V, the pattern gain can be changed to 2.00 to provide full scale control of the motor speed at +/- 0...10 V.

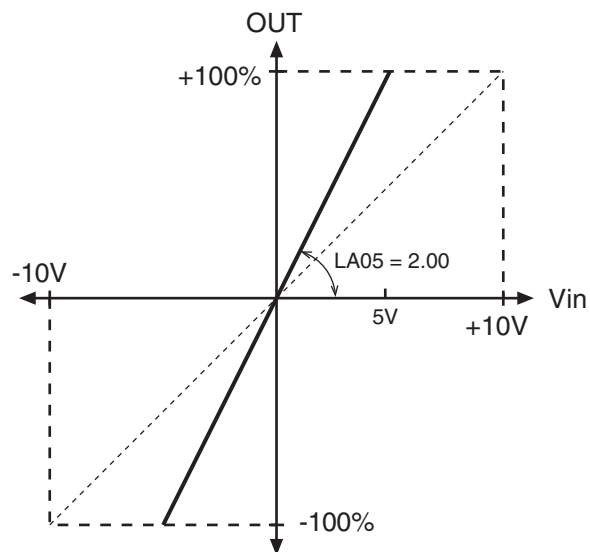

Example of Analog Input Gain = 2

LA06

This parameter shifts the input characteristic on the X-axis.

Analog Input 1 X Offset

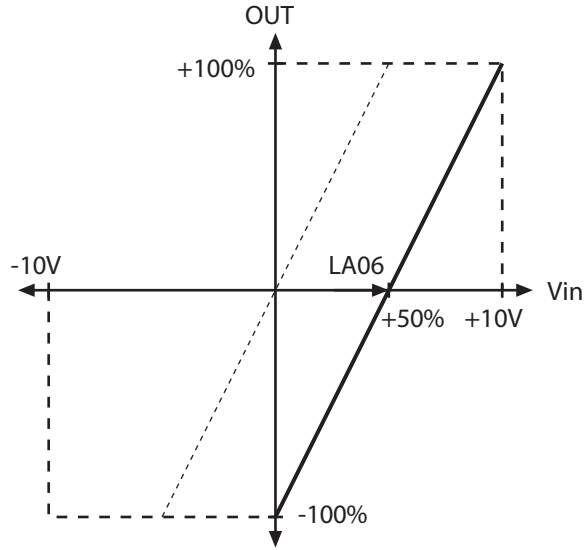

Example of 50% X-Offset

LA07

This parameter shifts the input characteristic on the Y-axis.

Analog Input 1 Y Offset

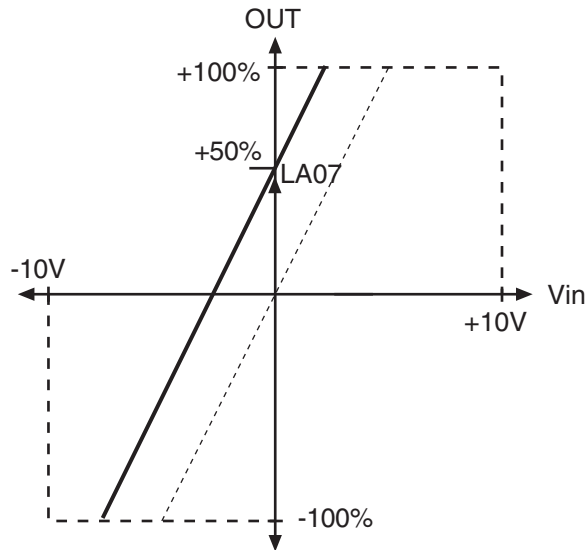

Example of 50% Y-Offset

LA - Analog I/O Parameters

Analog Input 2



Settings LA14-17 for Analog Input 2 (AnIn2) correspond to terminal inputs AN2+ and AN2-.

LA14

Refer to parameter LA04 for description.

Analog Input 2 Dead
Band

LA15

Refer to parameter LA05 for description.

Analog Input 2 Gain

LA16

Refer to parameter LA06 for description.

Analog Input 2 X Offset

LA17

Refer to parameter LA07 for description.

Analog Input 2 Y Offset

Analog Output 1



Settings LA31-35 for Analog Output 1 correspond with terminal ANOUT1.

LA31

Analog Output 1
Function

The following options in the table below can be assigned to the analog output. Speeds are scaled such that 10V = contract speed.

Setting:	0...10V =	NUM
Absolute actual speed	0...RPM at Contract Speed	0
Absolute command speed	0...RPM at Contract Speed	1
Actual speed	0...RPM at Contract Speed	2
Command speed	0...RPM at Contract Speed	3
Output voltage	0...500V	4
DC bus voltage	0...1000V	5
Phase current	0...2 x Rated Inverter Current	6
Actual Torque	0...3 x Rated Motor Torque	7
Default (LA31) = Actual Speed (2) Default (LA36) = Actual Torque (7)		



Similar to the analog inputs, with parameters LA33-35 or LA38-40, the corresponding analog output signals can be adapted in X and Y direction as well as in the gain. The input value corresponds to, pre-processed value internal to the drive and the output value would be the post-processed analog output voltage from the drive output terminals.

LA33

Analog Output 1 Gain

The analog pattern can be scaled directly through this parameter. As an example, if the required analog output should be 0 to 5V, then the gain value should be set to 50%.

Refer to parameter LA05 for further description.

LA34

Analog Output 1 X
Offset

This parameter shifts the input characteristic on the X-axis.

Refer to parameter LA06 for further description.

LA35

Analog Output 1 Y
Offset

This parameter shifts the input characteristic on the Y-axis.

Refer to parameter LA07 for further description.

LA - Analog I/O Parameters

Analog Output 2



Settings LA36-40 for Analog Output 2 correspond with terminal ANOUT2.

LA36

Refer to parameter LA31 for description.

Analog Output 2
Function

LA38

Refer to parameter LA33 for description.

Analog Output 2 Gain

LA39

Refer to parameter LA34 for description.

Analog Output 2 X
Offset

LA40

Refer to parameter LA35 for description.

Analog Output 2 Y
Offset

6.14 LO - Outputs Parameters

LO01

Allows the logic of the digital and relay outputs to be inverted.

Output Inversion

Setting Option:	NUM
None	0
/O1	1
/O2	2
/O1 + /O2	3
/RLY1	4
/RLY1 + /O1	5
/RLY1 + /O2	6
/RLY1 + /O1 + /O2	7
/RLY2	8
/RLY2 + /O1	9
/RLY2 + /O2	10
/RLY2 + /O1 + /O2	11
/RLY2 + /RLY1	12
/RLY1 + /RLY2 + /O1	13
/RLY1 + /RLY2 + /O2	14
/RLY1 + /RLY2 + /O1 + /O2	15
Default = None (0)	

LO05

O1 corresponds to the digital output "O1" - See section 3.1.1 & 3.2.2.

Output Function O1

This output is available to be programmed with the one of the following output functions listed on the next page.

LO10

O2 corresponds to the digital output "O2" - See section 3.1.1 & 3.2.2.

Output Function O2

This output is available to be programmed with the one of the following output functions listed on the next page.

LO15

RLY1 corresponds to "Relay 1" - See section 3.1.1 & 3.2.2.

Output Function RLY1

This output is available to be programmed with the one of the following output functions listed on the next page

LO20

RLY2 corresponds to "Relay 2" - See section 3.1.1 & 3.2.2.

Output Function RLY2

LO - Output Parameters

The outputs are available to be programmed with the one of the following output functions listed in table below.

Setting:	Description:	NUM
Off	Output is disabled	0
Fault	Output is set when there is a drive fault	1
Drive Ready	Output is set when there are no drive faults and the drive is ready for operation	2
Drive On	<p>Output indicates the drive is outputting and in control of the motor.</p> <p>The output is set when the motor phase current check (LX08; initiated by the drive enable and a direction input) has passed and the motor is magnetized, the LT01 Brake Release Delay has expired, and output voltage modulation has begun.</p> <p>The output turns off after the speed command has ramped down to zero, the direction input has been turned off, and the sum of the LT10 Brake Drop Delay and LT12 Current Hold Time have elapsed or immediately if the drive enable is dropped at any time or a drive fault occurs.</p> <p>If the drive enable has not been dropped or a drive fault does not occur, then after the LT12 Current Hold Time has elapsed and the Drive On output has turned off the drive will continue to ramp down the output current during the LT13 Current Ramp Down Time. During this ramp down time the drive is not in full control of the motor so the Drive On output will not be on even though current may still be output. Therefore, the brake should be set within the LT12 Current Hold Time before the LT13 Current Ramp Down time and the Drive On should not be used to control the brake. In addition, the drive enable input should remain on for at least the LT13 Current Ramp Down time after the Drive On output has turned off to prevent immediately shutting of the output current during the ramp down period which may cause a motor disturbance.</p>	3

Setting:	Description:	NUM
Brake Control	<p>Output is set when the motor is in control and the brake should be released.</p> <p>The output is set when the motor phase current check (LX08; initiated by the drive enable and a direction input) has passed and the motor is magnetized, the LT01 Brake Release Delay has expired, and output voltage modulation has begun.</p> <p>The output turns off after the speed command has ramped down to zero, the direction input has been turned off, and the LT10 Brake Drop Delay time has elapsed or immediately if the drive enable is dropped at any time or a drive fault occurs.</p>	4
At Speed	Output is set when there is no speed deviation between actual and command values, according to the LX14 Speed Difference.	5
High Speed *	Output is set whenever the speed is greater than two times LS01 Leveling Speed.	6
Deceleration Active *	Output is set when decel is active and the speed drops below LX16 Decel Confirmation Speed.	7
Speed for Door Pre-opening *	Output is set when the speed is below LX15 Speed for Pre-Opening to allow pre-opening of the doors.	8
Leveling Zone *	Output is set when less than 6 inches (15cm) from the floor. Note: floor position must be on	9
Main Contact Control	Output is set when the speed and direction inputs are signaled (direction only for analog and serial speed control modes) Output turns off at end of run after the current has ramped down and the drive enters Mode = No Direction (LS). This output function cannot be used in combination with LI15 Direction Selection Inputs = Down (I6) Input Only. Refer to LI04 Input Function 1 for further details on the Main Contact Control.	10

LO - Output Parameters

Setting:	Description:	NUM
Motor Overheat ***	Output is set when terminals T1 & T2 are open. Tells the controller to stop at the next floor	11
Cabinet Fan On ***	Output is set when the drive heatsink reaches 40 degrees Celsius	12
Condition 1	Output is linked to LO30-32.	13
NTSD Output	Output activates when NTSD slowdown is triggered and remains on until the direction is dropped or until the command speed is below the TS02 NTSD Target Speed (analog or serial speed control)..	14
Default (LO05) = At Speed (5) Default (LO10) = Deceleration Active (7) Default (LO15) = Off (0) Default (LO20) = Brake Control (4)		

* Only one of these four conditions can be selected at a time.

*** Only one of these two conditions can be selected at a time.

LO30

Data Value 1

When one of the output functions in LO05-20 is assigned as Condition 1, LO30 Data Value 1 is the value which will be evaluated against the LO32 Comparison Level 1 according to the operand LO31 Condition 1.

The setting for LO30 corresponds to the associated Dg parameter.

For example, when LO30 = 2, this corresponds to Dg02 Inverter Status.

If LO31 = '=' and if LO32 = 30, then the output would become active when the DG02 Inverter State = 30; Error Motor Protection (EOH2).

LO31

Condition 1

Determines the operand evaluating LO30 Data Value 1 against the LO32 Comparison Level 1.

The following operands are available according to the table below.

Setting:	Description:	NUM
<	LO30 Less Than LO32	7
<=	LO30 Less Than or Equal to LO32	6
=	LO30 Equal to LO32	5
>=	LO30 Greater Than or Equal to LO32	4
>	LO30 Greater Than LO32	3
< (AbsVal)	Absolute Value of Diagnostic parameter corresponding to LO30 Less Than the value of LO32	2
= (AbsVal)	Absolute Value of Diagnostic parameter corresponding to LO30 Equal to value of LO32	1
> (AbsVal)	Absolute Value of Diagnostic parameter corresponding to LO30 Greater Than the value of LO32	0

LO32

Comparison Level 1

The value which the LO30 Data Value 1 is compared against for evaluation according to the operand in LO31 Condition 1.

LO - Output Parameters

The diagram below is an abbreviated timing diagram of select output functions.

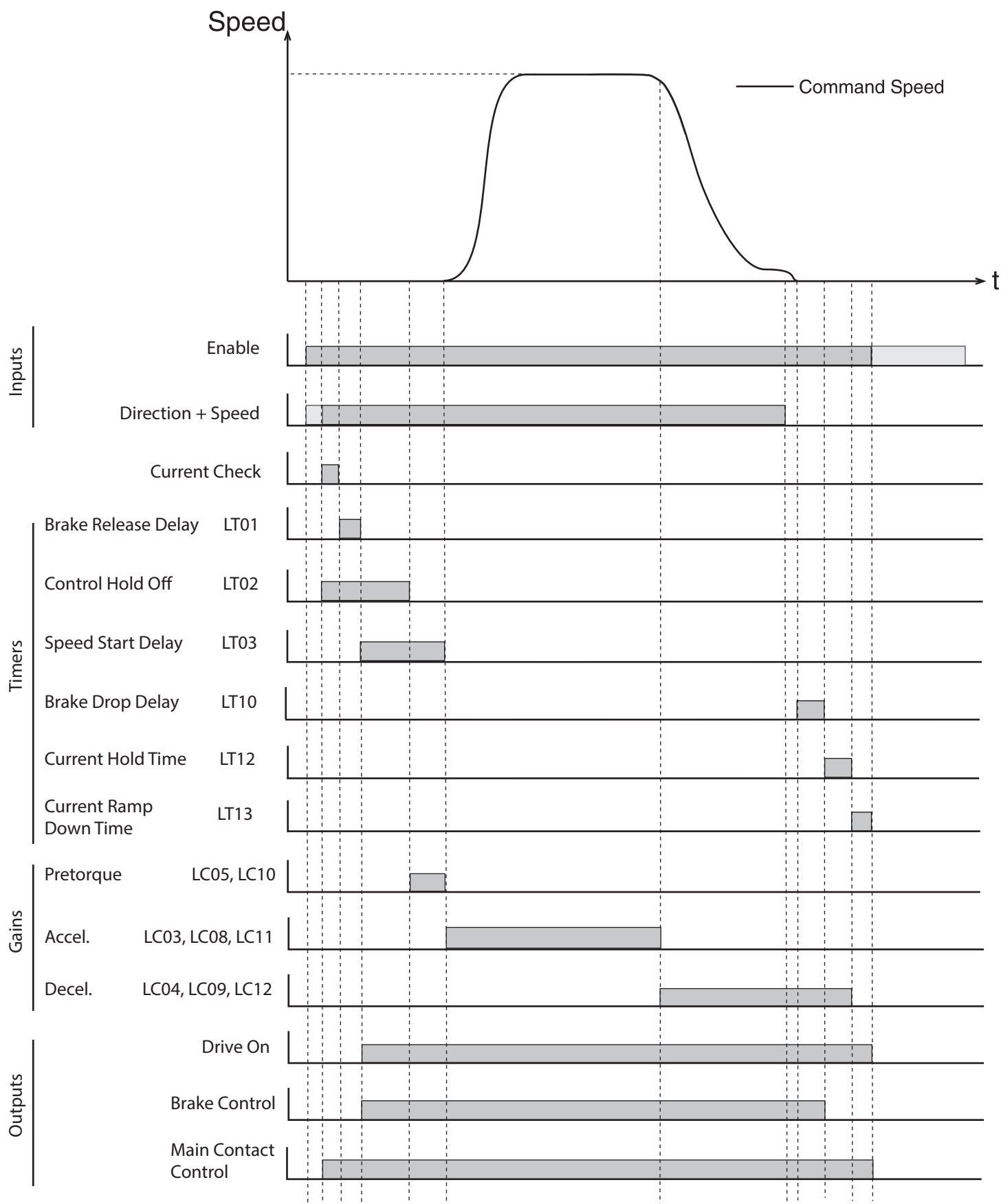

6.15 FB - Field Bus Parameters

DIN66019II Serial Protocol

The DIN66019II serial protocol consists of various services, which are defined telegram structures for serial communication between controller and keypad operator.

DIN66019II services 48, 49, and 50 will be supported. There will be an independent watchdog timer for the serial interface, the node ID will be adjustable from 1 to 128, and the available baud rates will be 9,600, 19,200, 38,400, 55,500, and 115,200.

- Service 48 = 2x32-bit
- Service 49 = 4x16-bit
- Service 50 = 2x16-bit + 1x32-bit + 1x32-bit AUX R/W*

*Service 50 AUX parameter channel can be used to access any read-only inverter or keypad operator parameter. Write capability is limited to operator parameters and only while the inverter status is Mode = Idle.

FB - Field Bus Parameters

Process Data Overview

The basic serial interface on the keypad operator consists of four 32-bit containers for incoming data (PDI - Process Data In) and four 32-bit containers for outgoing data (PDO - Process Data Out).

Depending on the DIN66019II service used, the string of PDI data from the telegram will be deposited into two or more of the containers. The containers are then mapped (Fb17-20) to a defined function (eg. Control Word, Speed, Pretorque, Absolute Target Position) with the function structure also defined. Depending on the function, the raw PDI data (Fb34-37) may be scaled or masked (Fb05-07) before being processed by the drive (Fb01-04).

The PDO data will originate from the Dg parameters in the operator (viewable from Combivis). This data will be mapped (Fb13-16) to the four PDO containers and then depending on the service, taken from the container and placed in the response telegram (Fb30-33).

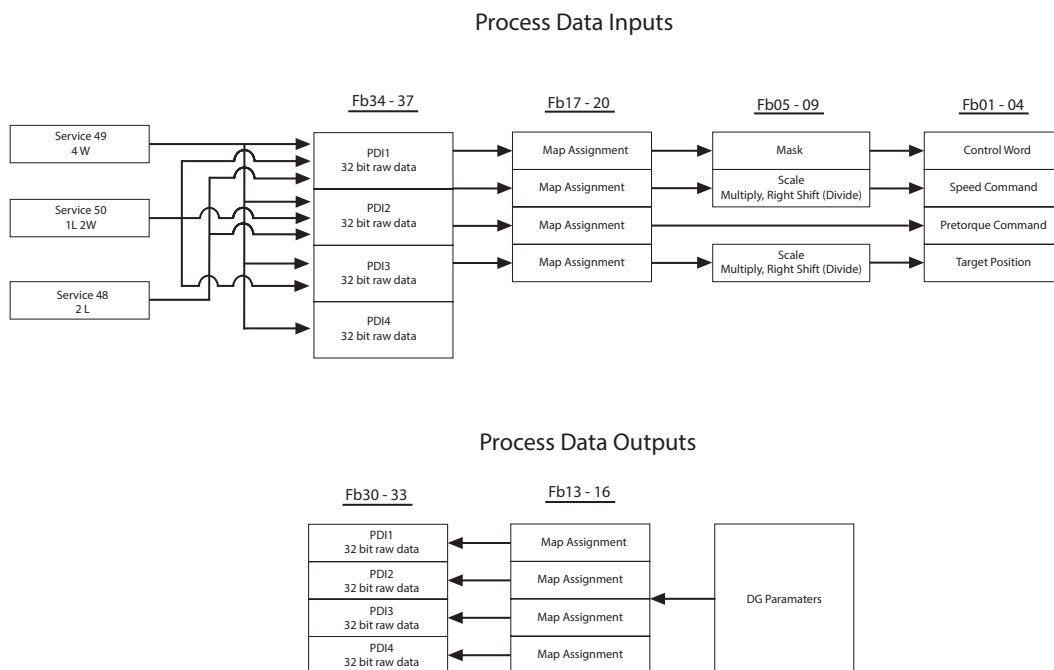

PDI - Process Data Inputs

For the PDI, there are four fixed-functions established, each with a corresponding structure definition: Control Word, Speed, Pretorque, and Absolute Target Position.

Control Word (16-bit)

The control word consists of serial inputs.

The raw inputs may be masked with parameter FB05 Control Word Mask.

Bit:	Function:
0	Enable
1	Reset
2	Up
3	Down
4	Binary Speed Input 1 or Binary Position 1
5	Binary Speed Input 2 or Binary Position 2
6	Binary Speed Input 3 or Binary Position 3
7	Reserved or Binary Position 4
8	Reserved or Binary Position 5
9	Special Function 1
10	Special Function 2
11	Special Function 3
12	Special Function 4
13	Special Function 5
14	Special Function 6
15	Special Function 7

Bits 0 - 3

Basic control word bits consisting of Enable, Up, Down, and Reset.

Bits 4 - 8

Assignment of serial selected binary-coded inputs for either speed or position.

Bits 9 - 15

Serial input selection of special functions. Serial and discrete digital inputs are independent unless assigned the same function; therefore, it is possible to have up to 14 functions defined between both serial and digital inputs.

Serial and/or digital inputs assigned the same function will be OR activated.

The available functions are the same as those for discrete digital inputs, described further under LI04.

FB - Field Bus Parameters

Speed Word (16-bit, signed)

Speed values are assigned FPM, with resolution 1 Raw = 0.1 FPM.

There is no dependence on the gear type (geared or gearless, US03 Motor Type). The scaling from FPM to RPM is done internally according to the machine data parameters: LN01 Traction Sheave Diameter, LN02 Gear Reduction Ratio, and LN03 Roping Ratio. Additional scaling of the raw speed value is available in the fieldbus parameters FB06 Speed Scale Multiplier and FB07 Speed Scale Shift Right (Divide).

Pretorque (16-bit, signed)

-100%...0...+100% Rated Motor Torque

Absolute Target Position

Method 1: Raw Counts

Method 2: 1 Raw = 1/10th inch

Additional scaling of the raw position value is available in the fieldbus parameters FB08 Position Scale Multiplier and FB09 Speed Scale Shift Right (Divide).

FB01-04: Processed PDI Data

After the raw PDI Data (FB34-37) has been received from the controller, it may be masked or scaled (FB05-09), depending which function (FB01-04: Control Word, Speed, Pretorque, Target Position) the data is mapped to via the PDI Map Assignments (FB17-20). The PDI Map Assignments will be chosen according to order each function's data within the telegram structure.

FB01

Read-only display of processed field bus control word in hexadecimal.

Field Bus Control Word

FB01 = PDI Data (Control Word) AND FB05 Field Bus Control Word Mask

FB02

Read-only display of processed field bus speed command, where 1 = 0.1 FPM.

Field Bus Speed

$$FB02 = \frac{\text{PDI Data (Speed)} \times \text{FB06 Speed Scale Multiplier}}{2^{\text{FB07 Speed Scale Shift Right}}}$$

PDI Data (Speed) is the FB34-37 parameter corresponding to speed, depending on the telegram structure. If the FB17-20 PDI Map Assignments are set according to the telegram structure, then they can be used to determine which corresponding FB34-37 PDI Data is used as raw data from the controller for speed.

FB03

Read-only display of processed pretorque, where 1 = 1%.

Field Bus Pretorque

FB03 = PDI Data (Pretorque)

FB04

Read-only display of processed field bus target position, where 1 = 1 count or 1 = 1/10th inch.

Field Bus Target Position

$$FB04 = \frac{\text{PDI Data (Target Position)} \times \text{FB08 Position Scale Multiplier}}{2^{\text{FB09 Position Scale Shift Right}}}$$

PDI Data (Target Position) is the FB34-37 parameter corresponding to target position, depending on the telegram structure. If the FB17-20 PDI Map Assignments are set according to the telegram structure, then they can be used to determine which corresponding FB34-37 PDI Data is used as raw data from the controller for target position.

FB - Field Bus Parameters

FB05-09: Operations on PDI

These parameters are used to mask or scale by multiplier or divide the raw data received from FB34-37. before being processed in FB01-04.

FB05

Bit mask ANDed with Field Bus Control Word.

Field Bus Control Word
Mask

FFFFh = No Mask, 0000h = Mask All.

FB06

Multiplier applied only to the Field Bus Speed command.

Speed Scale Multiplier

FB07

Divide ($1/2^x$) applied only to the Field Bus Speed command.

Speed Scale Shift
Right

FB08

Multiplier applied only to the Field Bus Target Position command.

Position Scale Multiplier

FB09

Divide ($1/2^x$) applied only to the Field Bus Target Position command.

Position Scale Right
Shift

FB10-12: Serial Communication Setup

FB10

DIN66019 Field Bus
Node ID

Node ID must be set to agree with Node ID used in serial communication service structure (default = 1).

FB11

DIN66019 Field Bus
Baud Rate

The serial communication baud rate corresponding to port X6C.

As a note, the LX12 Baud Rate corresponds to the (Combivis) diagnostics port X6D.

FB12

DIN66019 Field Bus
Watchdog

Watchdog of serial communication between the LCD keypad operator serial communications port, X6C, and controller.

Active only when Mode = Run (Home or Diagnostics Screen #6).

As a note, the LX09 Serial Comm. Watchdog Time corresponds to the communication between the LCD keypad operator and the inverter control card.

FB - Field Bus Parameters

FB13 - 16: Process Data Output Addresses

These are the mapping of diagnostic parameter hex address for Process Data Out. For example, FB13 PDO1 = 1182h = DG02 Inverter Status. These parameters have the same structure as FB17-20; refer to these parameters for further description.

The defaults are established such that:

PDO	US04 Control Type, DIN66019		
	Service 49 (4)	Service 50 (5)	Service 50 Serial Binary (6)
PDO1	(1182h) DG02 Inverter Status	(1182h) DG02 Inverter Status	(1182h) DG02 Inverter Status
PDO2	(11B2h) DG50 Elevator Speed	(11B2h) DG50 Elevator Speed	(11B2h) DG50 Elevator Speed
PDO3	(1185h) DG05 Actual Torque	(118Bh) DG11 Output Status	(1185h) DG05 Actual Torque
PDO4	(1186h) DG06 Motor Current	(11B3h) DG51 Mode	(11B3h) DG51 Mode

FB13

PDO1 Map Assignment

Hexadecimal address of diagnostics parameter mapped as Process Data Output 1.

FB14

PDO2 Map Assignment

Hexadecimal address of diagnostics parameter mapped as Process Data Output 2.

FB15

PDO3 Map Assignment

Hexadecimal address of diagnostics parameter mapped as Process Data Output 3.

FB16

PDO4 Map Assignment

Hexadecimal address of diagnostics parameter mapped as Process Data Output 4.

Fb17 - 20: Process Data Input Addresses

The function associated with PDI1, 2, 3, 4 must be assigned according to the information contained in the controller telegram structure.

Parameter Structure (12345678):

Field Bus Parameter Hex Address (1 - 4) + Set (5 - 6) + Size, Bytes (7 - 8)

- The Field bus Parameter Hex Address is the keypad operator parameter address of the PDI function which data is mapped to.
For example, if FB17 PDI1 = **12810102**, this would correspond to FB01 (1281h) = Control Word; thus PDI1 = Control Word.
- Set: This can be fixed at 01
- Size: 16-bit = 02, 32-bit = 04

The defaults are established such that:

PDi	US04 Control Type, DIN66019		
	Service 49 (4)	Service 50 (5)	Service 50 Serial Binary (6)
PDI1	(1281h) FB01 Control Word	(1282h) FB02 Speed	(1281h) FB01 Control Word
PDI2	(1282h) FB02 Speed	(1281h) FB01 Control Word	(1282h) FB02 Speed
PDI3	(1283h) FB03 Pretorque	(1283h) FB03 Pretorque	(1283h) FB03 Pretorque
PDI4	(1284h) FB04 Target Position	(1284h) FB04 Target Position	(1284h) FB04 Target Position

FB17

PDI1 Map Assignment

Field bus parameter hex address, set, size, and bytes corresponding to Process Data Input 1.

FB18

PDI2 Map Assignment

Field bus parameter hex address, set, size, and bytes corresponding to Process Data Input 2.

FB19

PDI3 Map Assignment

Field bus parameter hex address, set, size, and bytes corresponding to Process Data Input 3.

FB20

PDI4 Map Assignment

Field bus parameter hex address, set, size, and bytes corresponding to Process Data Input 4.

FB - Field Bus Parameters

FB21 - 27: Process Data Input Function Selection

Function selection via control word serial inputs. The available functions are the same as those for discrete digital inputs, described under parameter LI04.

If both discrete digital input and serial input are assigned as the same function, then function will be OR-activated.

FB21

Field Bus Special
Function 1

Function selection via serial input corresponding to Control Word bit 9.

FB22

Field Bus Special
Function 2

Function selection via serial input corresponding to Control Word bit 10.

FB23

Field Bus Special
Function 3

Function selection via serial input corresponding to Control Word bit 11.

FB24

Field Bus Special
Function 4

Function selection via serial input corresponding to Control Word bit 12.

FB25

Field Bus Special
Function 5

Function selection via serial input corresponding to Control Word bit 13.

FB26

Field Bus Special
Function 6

Function selection via serial input corresponding to Control Word bit 14.

FB27

Field Bus Special
Function 7

Function selection via serial input corresponding to Control Word bit 15.

FB30 - 33: PDO Data

The PDO Data are the actual value of the of the process data out, linked to the diagnostics parameters from the FB13-16 map assignments.

FB30

PDO1 Data

Actual value of Process Data Output 1.

FB31

PDO2 Data

Actual value of Process Data Output 2.

FB32

PDO3 Data

Actual value of Process Data Output 3.

FB33

PDO4 Data

Actual value of Process Data Output 1.

FB34 - 37: PDI Data

The PDI Data is the actual raw data received from the controller and mapped to the functions according to the FB17-20 PDI Map Assignments. The data displayed is the raw data before being masked, scaled by parameters FB05-09, then processed by the drive in FB01-04.

FB34

PDI1 Data

Actual Process Data Input 1 value from controller before Mask, Shift, or Multiplier.

FB35

PDI2 Data

Actual Process Data Input 2 value from controller before Mask, Shift, or Multiplier.

FB36

PDI3 Data

Actual Process Data Input 3 value from controller before Mask, Shift, or Multiplier.

FB37

PDI4 Data

Actual Process Data Input 4 value from controller before Mask, Shift, or Multiplier.

FB - Field Bus Parameters

FB50 - 53: DIN66019 Serial Communication Error Logs

FB50

Used for troubleshooting.

Temporary DIN
Communication Error
Counter

FB51

Used for troubleshooting.

Temporary DIN
Communication Error
Service

FB52

Used for troubleshooting.

Temporary DIN
Communication Error
Acknowledgement

FB53

Used for troubleshooting.

Temporary DIN
Communication Error
Value

FB54

This parameter is used to control the transmit enable, TxE, in regards to the response telegram from the drive when using DIN66019 serial communication..

RS485 Mode

Setting:	Description:	NUM
Full Duplex	Single Node - Transmit enable is held ON.	0
Half Duplex	Mutli-drop - Transmit enable shuf off after each response telegram	1
Default = Full Duplex (0)		

FB55

Software Filter

By using a FB55, the fieldbus input speed can be filtered. This allows for the keypad operator to have an interpolation between the values that are being given over the fieldbus. This allows for a less jagged response inside of the inverter due to the update rate being 5 ms between keypad operator and inverter, whereas the update rate between the controller and keypad operator can be much longer.

The FB55 Software Filter is the amount of time in milliseconds in which the filter will average over. If this is at least twice the input frequency (eg. serial update time), then the keypad operator will be generating a new value for the inverter during the acceleration and deceleration periods. This allows for if there is a telegram loss, then the inverter will still receive a new value and the disturbance will not be as great.

As a note, the LX11 Reference Splitting can also be used for interpolation of the serial profile and is typically set at twice the serial update time, in milliseconds.

DG - Diagnostics Parameters (Combivis only)

6.16 DG - Diagnostics Parameters (Combivis only)

The DG diagnostics parameter group is only viewable from the computer software program Combivis and not from the keypad operator. Most diagnostics can be found in the Diagnostics Menu from the Home screen. Refer to section 7.1 for additional information.

In some cases, other parameters can be linked to DG parameters (eg. Fb13-16 PDO Map Assignments, LO30 Data Value 1 output condition).

The following table lists an overview of the DG parameters. Additional information on select parameters may be found in the parameter descriptions following the table.

Para:	Name:	Unit - English:	Unit - Metric:	Hex:
DG01*	Input Status			1181h
DG02*	Inverter Status			1182h
DG03	Command Speed	rpm	rpm	1183h
DG04	Elevator Position	in	mm	1184h
DG05	Actual Torque	lb-ft	Nm	1185h
DG06	Motor Current	A	A	1186h
DG07	Motor Speed	rpm	rpm	1187h
DG08	DC Bus Voltage	VDC	VDC	1188h
DG09	Magnetizing Current	A	A	1189h
DG10	Modulation Grade	%	%	118Ah
DG11*	Output Status			118Bh
DG16*	Output Condition State			1190h
DG17	Output Frequency	Hz	Hz	1191h
DG18	Output Voltage	V	V	1192h
DG19*	Parameter Set			1193h
DG20	Raw Pattern	%	%	1194h
DG21	Processed Pattern	%	%	1195h
DG30	Peak DC Volts	VDC	VDC	119Eh
DG31	Peak Current	A	A	119Fh
DG32	Peak Speed	ft/min	m/s	11A0h
DG33	Raw Pretorque	%	%	11A1h
DG34	Post Pretorque	%	%	11A2h
DG35	Analog Output 1	V	V	11A3h
DG36	Analog Output 2	V	V	11A4h
DG37	Heatsink Temperature	C	C	11A5h
DG38	Motor Temperature	C	C	11A6h

Para:	Name:	Unit - English:	Unit - Metric:	Hex:
DG39	Carrier Frequency	kHz	kHz	11A7h
DG40	Electric Power	kW	kW	11A8h
DG41	Motor Power	kW	kW	11A9h
DG42	Braking Energy	kWh	kWh	11AAh
DG43	Power On Counter	h	h	11ABh
DG44	Run Time Counter	h	h	11ACh
DG45	Overload Counter	%	%	11ADh
DG46	Drive Load	%	%	11AEh
DG47	Peak Load	%	%	11AFh
DG50	Elevator Speed	ft / min	m / s	11B2h
DG51*	Mode			11B3h
DG52*	Active Profile			11B4h
DG53*	Active Speed			11B5h
DG54	Leveling Distance	in	cm	11B6h
DG55	Target Floor			11B7h
DG56	Current Floor			11B8h
DG57	Next Avail. Floor			11B9h
DG58	Car Load	%	%	11BAh
DG59	Brake Release Time	s	s	11BBh
DG60	Average Regen Power	kW	kW	11BCh
DG61	Peak Regen Power	kW	kW	11BDh
DG62	Runs Per Hour	ft / min	m / s	11BEh
DG63*	NTSD Speed 1 Up	ft / min	m / s	11BFh
DG64*	NTSD Speed 2 Up	ft / min	m / s	11C0h
DG65*	NTSD Speed 3 Up	ft / min	m / s	11C1h
DG66*	NTSD Speed 1 Down	ft / min	m / s	11C2h
DG67*	NTSD Speed 2 Down	ft / min	m / s	11C3h
DG68*	NTSD Speed 3 Down	ft / min	m / s	11C4h

*Denotes additional information regarding parameter listed in parameter description.

DG - Diagnostics Parameters (Combivis only)

DG01

Input Status

The displayed numerical value is the sum of the individual inputs weightings.
For example, $DG01 = 5 = I7 (1) + I15 (4)$.

Value:	Input:
0	None
1	I7
2	I8
4	I5
8	I6
16	I1
32	I2
64	I3
128	I4

DG02

Inverter Status

The following table describes the various inverter statuses and the value corresponding to each.

Value:	Description:
0	No Operation
1	EOP - Error Over Voltage
2	EUP - Error Under Voltage
3	EUPh - Error Input Phase Failure
4	EOC - Error Over Current
5	EIPh - Error Output Phase Failure
6	EOHI - Error Overheat Internal
7	EnOHI - No Error Overheat Internal
8	EOH - Error Overheat Power Module
9	EdOH - Error Motor Overheat
11	EndOH - No Error Motor Overheat
12	EPU - Error Power Unit
13	no_PU - Power Unit Not Ready
15	ELSF - Error Charge Relay Fault
16	EOL - Error Overload
17	EnOL - No Error Overload
18	EbuS - HSP5 Serial Comm.
19	EOL2 - Error Overload Low Speed
20	EnOL2 - No Error Overload Low Speed
23	ESbuS - Error Bus Synchronization
24	EACC - Error Maximum Acceleration
25	ESCL - Error Speed Control Limit
30	EOH2 - Error Motor Protection
31	EEF - Error External Fault
32	EEnC1 - Error Encoder 1
34	EEnC2 - Error Encoder 2
35	EEnCC - Error Encoder Interface
36	EnOH - No Error Overheat Power Module
39	ESEt - Error Set
44	ESLf - Error Software Limit Forward
45	ESLr - Error Software Limit Reverse
46	EPrF - Error Protection Rotation Forward
47	EPrr - Error Protection Rotation Reverse
49	EPuci - Error Power Unit Code Invalid
50	EPuch - Power Unit Changed
51	Edri - Error Driver Relay
52	EHyb - Error Encoder Card

DG - Diagnostics Parameters (Combivis only)

Value:	Description:
53	EiEd - Input Error Detection
54	Eco1 - Error Counter Overrun 1
55	Eco2 - Error Counter Overrun 2
56	Ebr - Error Low Motor Current
57	Eini - Error Initialization MFC
58	EOS - Error Overspeed
59	EHybC - Error Encoder Card Changed
60	ECdd - Error Calculating Motor Data
64	Up Acceleration
65	Up Deceleration
66	Up Constant Speed
67	Down Acceleration
68	Down Deceleration
69	Down Constant Speed
70	No Direction Selected
71	Stall
72	LA Stop
73	Ld Stop
74	Speed Search
75	DC Brake
76	Base Block
77	Low Speed / DC Brake
78	Power Off
79	Quick Stop
80	Hardware Current Limit
81	Search for Reference Active
82	Calculate Motor Data
83	Positioning
84	Low Speed / Power Off
85	Closing Brake
86	Opening Brake
87	Abnormal Stop Overheat Interior
88	No Alarm Overheat Power Module
89	Abnormal Stop Overheat Power Module
90	Abnormal Stop External Fault
91	No Alarm Drive Overheat
92	No Alarm Stop Overheat Interior
93	Abnormal Stop Bus
94	Abnormal Stop Protection Rotation Forward
95	Abnormal Stop Protection Rotation Reverse

Value:	Description:
96	Abnormal Stop Drive Overheat
97	Abnormal Stop Motor Protection
98	No Abnormal Stop Overload
99	Abnormal Stop Overload
100	Abnormal Stop Overload 2
101	No Abnormal Stop Overload 2
102	Abnormal Stop Set
103	Abnormal Stop Bus Synchronization
104	Abnormal Stop Software Limit Forward
105	Abnormal Stop Software Limit Reverse
106	Abnormal Stop Maximum Acceleration
107	Abnormal Stop Speed Control Limit
121	Ready for Positioning
122	Positioning Active
123	Position Not Accessible
124	Protection Rotation Forward
125	Protection Rotation Reverse
126	Position Not Accessible Ignored
127	Calculate Motor Data Complete
128	Reference Found
150	Main Contact Failure
151	Brake Switch Failure
152	Speed Following Error
153	Speed Selection Error
154	ETS Input Failure
155	ETS Overspeed
156	NTS Input Failure
157	Analog Signal Failure
158	Unintended Movement
159	Secure Fault Reset
160	ESD Input Failure
161	Direction Selection Failure
162	Drive Enabled Switched Off
163	Error Field Bus Watchdog
164	Error Commutation Position
165	Error Excessive Acceleration
166	Error Serial Command Speed
170	UPS Mode
171	Reduced Torque
172	Emergency Profile

DG - Diagnostics Parameters (Combivis only)

Value:	Description:
173	Emergency Generator Speed
174	Earthquake Speed
175	Emergency Slowdown
200	No Communication to Encoder Card
201	Encoder Communication OK
202	Encoder Not Defined
206	No Communication to Encoder
207	Incremental Count Deviation
208	Encoder PPR does not match LE01
209	Interface ID is wrong
213	Encoder Overtemperature
214	Encoder Overspeed
215	Encoder Supply Voltage Too Low
216	Internal Encoder Error
217	Formatting Encoder
221	New Encoder Identified
222	Undefined Encoder Error
223	Encoder Interface Busy

DG11

Output Status

The displayed numerical value is the sum of the individual output weightings.
For example, DG11 = 12 = Relay 1 (4) + Relay 2 (8).

Value:	Description:
0	None
1	Output 1
2	Output 2
4	Relay 1
8	Relay 2

DG16

Output Condition State

The displayed numerical value is the sum of the individual output condition weightings.

Value:	Description:
0	None
1	Condition 0
2	Condition 1
4	Condition 2
8	Condition 3
16	Condition 4
32	Condition 5
64	Condition 6
128	Condition 7

DG19

Parameter Set

The Parameter Set indicates the state of the run sequence in the drive.

Value:	Description:
0	
1	
3	
4	
5	
6	
7	

DG - Diagnostics Parameters (Combivis only)

DG51

The Mode indicates the operating state of the keypad operator.

Mode

Value:	Description:
5	Idle - Program
6	Idle
21	Fault Reset
22	Fault
32	Check Special Function
34	Activate Special Function
37	Tune Motor Pre
38	Tune SPI Pre
39	Tune Pole Pre
40	Tune Encoder Pre
41	Tune Inertia Pre
42	Tune Overspeed Pre
43	Tune Safety Pre
48	No Direction (LS)
50	Brake Off Up
52	Brake Off Down
54	Start Delay
56	Tune Motor
57	Tune SPI
58	Tune Pole
64	Determine Speed
68	External Profile Run
80	Stopping
82	Brake On
84	End Run Reset
86	Special Function Reset
96	End Run Idle
97	Tune Motor Post Fail
98	Tune Motor Post OK
99	Tune SPI Post Fail
100	Tune SPI Post OK
101	Tune Pole Post Fail
10	Tune Pole Post OK
103	Tune Encoder Post
104	Tune Inertia Post
105	Tune Overspeed Post
106	Tune Safety Post
255	Not Configured

DG52

The Active Profile displays which speed profile is active.

Active Profile

Value:	Description:
0	None
1	Inspection
2	High Speed
4	One Floor
8	Emergency
16	Correction
32	Emergency Slowdown

DG53

The Active Speed displays which selected speed is active.

Active Speed

Value:	Description:
0	None
32	Inspection Speed
64	Leveling Speed
96	Correction Speed
128	High Speed
160	Intermediate Speed 1
256	Earthquake Speed
384	Intermediate Speed 2
512	Emergency Generator Speed
640	Intermediate Speed 3
768	UPS Speed

DG63 - 68

Displays the motor speed at which the corresponding NTSD input was last dropped in the corresponding direction.

NTSD Speed

TS - Terminal Slowdown Data Parameters

6.17 TS - Terminal Slowdown Parameters

Overview

The terminal slowdown parameters configure the settings for inputs assigned as Normal Terminal Slowdown (NTS) inputs. (LI04-11).

The purpose of the NTS inputs is to provide an expedited and/or an alternate slowdown means when the elevator speed approaching a terminal landing is greater than a defined level. If this level is exceeded, the drive will perform an NTS stop; otherwise, the drive will continue as normal.

Up to three NTS speed thresholds in each direction can be set with each input corresponding to an NTS speed threshold or two inputs can be binary-coded (TS01 NTSD Mode). This provides multiple checks during slowdown as the contract speed increases.

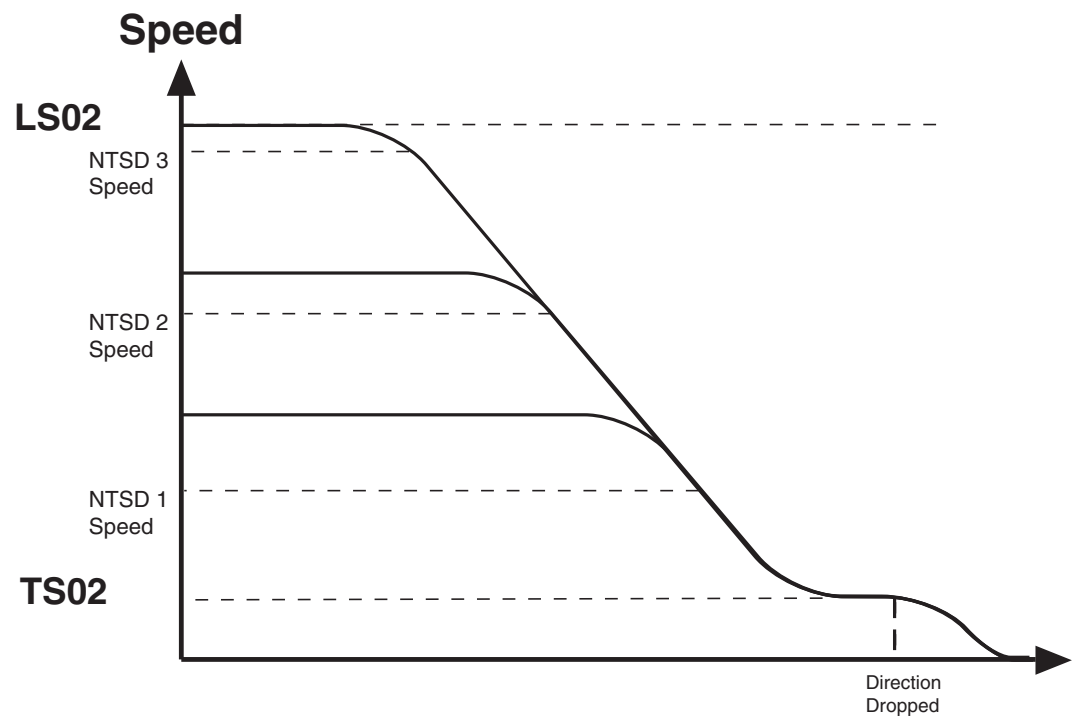

Function

The NTS input is an active low input controlled by the controller.

When the NTS input is dropped (pulse or constant), the drive will begin to compare the encoder speed against the corresponding NTSD threshold and direction (TS03-08).

IF the encoder speed becomes GREATER than the corresponding NTSD speed threshold (TS03-08), then the drive will decelerate to the TS02 NTSD Target Speed using the LS33-35 One Floor profile deceleration and jerk rates, bypassing any controller generated serial or analog profile, and continue on until the hardware direction input is dropped then decelerate to zero speed. If the external (analog or serial) speed command is less than the TS02 NTSD Target Speed, the drive will follow the external command speed but continue to limit the maximum speed to the TS02 NTSD Target Speed until the end of the run when the hardware direction command is dropped.

ELSE, IF the encoder speed remains LESS than the corresponding NTSD speed threshold (TS03-08), the drive will continue as normal.

An output can be assigned (LO05-20) as NTSD Output, indicating when the NTS slowdown is active. The output turns on when an NTS slowdown is initiated and remains on until the direction is dropped or while the command speed is below the TS02 NTSD Target Speed (analog or serial speed control)..

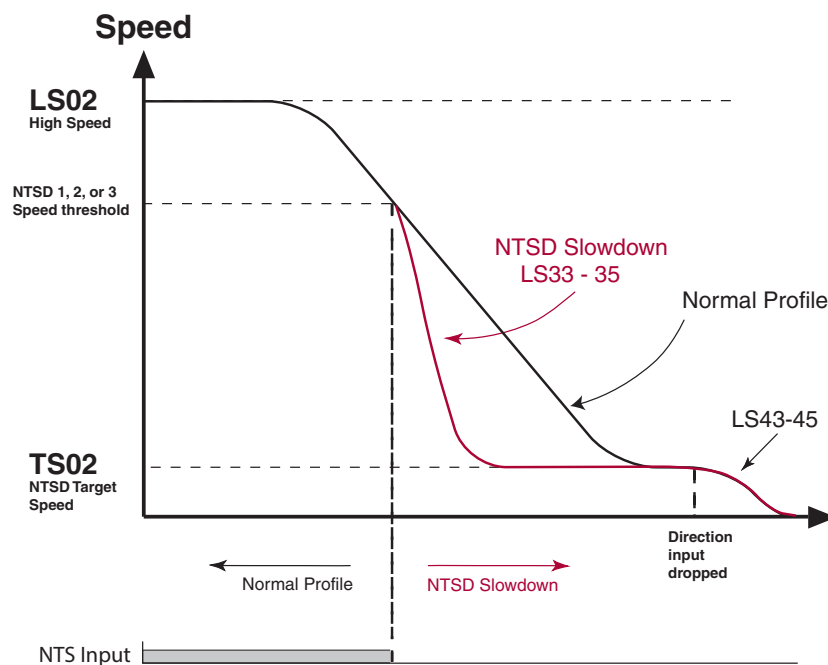

TS - Terminal Slowdown Data Parameters

NTSD Timing Diagram and Example

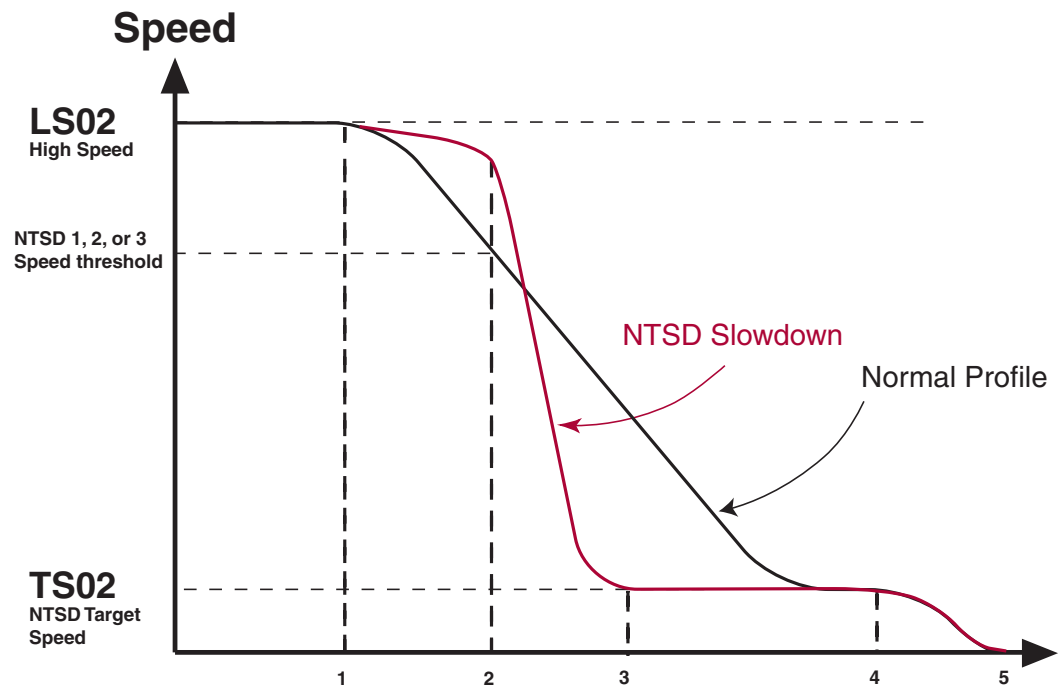

The diagram above and corresponding sequence (1-5) descriptions below show an example of a normal run (A) and a run in which the NTS is initiated (B).

1. Normal slowdown initiated.
 - A. Motor tracks command speed.
 - B. Motor speed deviates from command speed.
2. NTS input dropped. Motor encoder speed compared with NTSD speed threshold.
 - A. Motor speed less than or equal to NTSD speed threshold ->
 1. Normal deceleration.
 - B. Motor speed greater than NTSD speed threshold ->
 1. Initiate NTSD Slowdown using LS33-35 One Floor profile rates
 2. NTSD output turns on
 3. Maximum speed limited to TS02 NTSD Target Speed until end of run.
3. NTS slowdown reaches NTSD Target Speed.
 - A. Normal slowdown active.
 - B. External speed command (analog or serial) below NTSD Target Speed allowed; NTSD Output turns off if external (analog or serial) speed command is less than NTSD Target Speed.
4. Direction dropped.
 - A. Decelerate to zero speed.
 - B. Decelerate to zero speed.
5. Drive enable dropped.
 - A. End of run.
 - B. End of run.

TS01

NTSD Mode

The NTSD Mode defines the assignment of the NTS inputs to the NTSD speed thresholds.

The NTSD inputs can be assigned in parameters LI04-LI11 to the corresponding hardware inputs X2A.10 - 18 or by FB21 - 27 to the corresponding serial Control Word special function bits 9 - 15.

- NTS1 (Normal Terminal Slowdown 1), NUM = 29
- NTS2 (Normal Terminal Slowdown 1), NUM = 30
- NTS3 (Normal Terminal Slowdown 1), NUM = 31

Setting:	Description:	NUM
External	No function.	0
Threshold 1	Single NTSD threshold	1
Threshold 2, Binary Encoded	Two NTSD thresholds, binary coded from two inputs	2
Threshold 3, Binary Encoded	Three NTSD thresholds, binary coded from two inputs	3
One switch per threshold	Three NTSD thresholds, each assigned to an individual input	4
Default = External (0)		

The following tables indicate the NTSD speed threshold according to the NTSD mode and input states.

TS - Terminal Slowdown Data Parameters

Threshold 1, NUM = 1

NTSD Input 2	NTSD Input 1	Function
x	1	Normal operation
x	0	Evaluate NTSD 1 Speed

Threshold 2, Binary Encoded, NUM = 2

NTSD Input 2	NTSD Input 1	Function
1	1	Normal operation
0	1	Evaluate NTSD 2 Speed
0	0	Evaluate NTSD 1 Speed
1	0	Evaluate NTSD 1 Speed

Threshold 3, Binary Encoded, NUM = 3

NTSD Input 2	NTSD Input 1	Function
1	1	Normal operation
1	0	Evaluate NTSD 3 Speed
0	1	Evaluate NTSD 2 Speed
0	0	Evaluate NTSD 1 Speed

One switch per threshold, NUM = 4

NTSD Input 3	NTSD Input 2	NTSD Input 1	Function
0	0	0	Normal operation
0	1	1	Evaluate NTSD 3 Speed
1	0	1	Evaluate NTSD 2 Speed
1	1	0	Evaluate NTSD 1 Speed

Symbol:

1	=	Input is active
0	=	Input is not active
x	=	Setting has no effect or doesn't care

TS02

NTSD Target Speed

The speed, when NTSD is active, to which the drive will decelerate and maintain as the maximum speed until the end of the run (enable dropped). With analog and serial speed control, a speed command below the NTSD target speed is allowed. When the direction command is dropped the LS43 - 45 emergency profile deceleration and jerk rates will be used to decelerate to zero speed.

TS03 - 08: NTSD Thresholds and Direction

The speed threshold which the motor encoder speed is compared against when the corresponding NTSD input drops (activates), in the indicated direction. If the motor speed is above this threshold, the drive will initiate an NTSD slowdown using the LS33 - 35 One Floor profile deceleration and jerk rates.

TS03

NTSD 1 Speed Up

Speed threshold for NTSD 1 in the up direction.

TS04

NTSD 2 Speed Up

Speed threshold for NTSD 2 in the up direction.

TS05

NTSD 3 Speed Up

Speed threshold for NTSD 3 in the up direction.

TS06

NTSD 1 Speed Down

Speed threshold for NTSD 1 in the down direction.

TS07

NTSD 2 Speed Down

Speed threshold for NTSD 2 in the down direction.

TS08

NTSD 3 Speed Down

Speed threshold for NTSD 3 in the down direction.

Diagnostics and Troubleshooting

7. Diagnostics and Troubleshooting

7.1 Diagnostics Screens

Home Screen	
Inverter Status	Mode
Motor Speed	Command Speed
Elevator Speed	Motor Current
Diagnostic Screen # 1	
Inverter Status	Motor Current
DC Bus Voltage	Peak Current
Peak DC Volts	Magnetizing Current
Diagnostic Screen # 2	
Inverter Status	Command Speed
Elevator Speed	Motor Speed
Peak Speed	Modulation Grade
Diagnostic Screen # 3	
Inverter Status	Motor Speed
Output Condition State	Output Frequency
Actual Torque	Output Voltage
Diagnostic Screen # 4	
Inverter Status	Parameter Set
Input Status	
Output Status	
Diagnostic Screen # 5	
Inverter Status	Command Speed
Raw Pattern	Raw Pretorque
Processed Pattern	Post Pretorque
Diagnostic Screen # 6	
Inverter Status	Mode
Analog Output 1	
Analog Output 2	
Diagnostic Screen # 7	
Heatsink Temperature	Motor Current
Motor Temperature	Carrier Frequency
Electric Power	Motor Power
Diagnostic Screen # 8	
Power On Counter	Overload Counter
Run Time Counter	Drive Load
Braking Energy	Peak Load

Diagnostic Screen # 9	
Operator Software Date (ddmm.y)	Drive Config ID
Drive Software Version	Encoder Interface Software
Drive Software Date (ddmm.y)	Enc. Interface Software Date
Diagnostic Screen # 10	
Inverter Status	Active Profile
Elevator Speed	Active Speed
Elevator Position	Leveling Distance
Diagnostic Screen Log	
MM/DD/YYYY HH:MM:SS (Most Recent) Fault or Special Operating Mode MM/DD/YYYY HH:MM:SS (Oldest) Fault or Special Operating Mode	
Diagnostic Screen # 12	
NTSD Speed 1 Up	NTSD Speed 1 Down
NTSD Speed 2 Up	NTSD Speed 2 Down
NTSD Speed 3 Up	NTSD Speed 3Down

Diagnostics and Troubleshooting

7.2 Drive Faults

Faults and error, listed alphabetically. Additional troubleshooting of operational problems is listed in Section 7.3 and diagnostics solutions in Section 7.4.

Error/Message	Alt. / (NUM)	Description	Cause/Solution/Troubleshoot
Abnormal Stop Bus	EBus	Indicates no serial communication between keypad operator and controller	Parameters FB50 - 53 show the error count, service, and value of both serial ports X6C and X6D. If the service is 99 and the error is 9, then there is a framing or parity error. This could indicate if the baud rate is incorrect, telegrams invalid, or potentially loss of serial communication due to noise. Check setting of FB11 DIN66019 Fb Baud Rate. Invalid serial telegrams being received.
Analog Signal Failure*	- (157)	Analog speed command not present at the beginning of a run.	When US04 = Bi-polar (3) or Absolute (2) Analog Speed, the analog speed command must be received within $t=2.5(LT01+LT03)$ sec. at beginning of run. Refer to additional information at end of section.
Base Block	bbL (76)	This message precedes most faults and indicates the drive enable (I7) was removed while the drive was outputting current. This is not a drive fault.	Indicates the output transistors have been safely shut off and are being blocked from further operation. This generally indicates the drive enable input (I7) was dropped prematurely or abruptly while the drive was still outputting current. This is not a drive error or fault, but a status message.
Brake Switch Failure*	- (151)	Brake switch not open/closed at beginning/end of run.	When LI04-11 input set as Brake Release confirmation, switch must open at beginning of run within $t=LT01+LT03+2.5$ sec and close at end within $t=LT10+LT12$. Refer to additional information at end of section.
Direction Selection Failure*	- (161)	Both directions signaled at beginning of run.	For LI15 = Up (I5) and Down (I6) inputs, the up/down directions must independently be selected. If both are selected simultaneously, the 'Direction Selection Failure' fault will occur, but not during UPS Operation Mode (refer to LI04 UPS Operation for further details).

Error/Message	Alt. / (NUM)	Description	Cause/Solution/Troubleshoot
Drive Enable Switched Off*	- (162)	Drive Enable (I7) input dropped while current output.	Will occur whenever the Drive Enable (I7) is dropped while current is being output. Check input signal connections, sequence, or reason for abrupt stop. (eg. emergency stop, clip door lock, etc.)
Error Calculate Motor Data	ECdd (60)	The inverter is unable to learn a value during the Motor Learn procedure or during automatic learn of the encoder position during each run.	<p>Verify correct motor data is entered in LM01-07 and re-try.</p> <p>Make sure motor contactor is closing.</p> <p>Make sure motor is wired correctly.</p> <p>If the problem persists, contact KEB.</p>
Error Charge Relay Fault	ELSF (15)	Load shunt fault	<p>Load-shunt relay has not picked up, occurs for a short time during the switch-on phase, but would automatically be reset immediately.</p> <p>If the error message remains the following causes may be applicable:</p> <ul style="list-style-type: none"> Load-shunt defective - Replace inverter Input voltage incorrect or too low Braking resistor connected to wrong terminals or braking transistor defective (See Appendix on how to test braking transistor). <p>Failure of the load shunt could result from excessive power cycling of the inverter without allowing the unit to fully power down, which may also be a result of frequent brown-outs.</p> <p>Use of a 230V single phase UPS power supply with a 480V drive is permitted and can be accomplished with the input function UPS Operation to reduce the under voltage error limit, although if the waveform is not a sine wave then the DC bus voltage may be less than the 280VDC required to reset the fault. It is suggested to let the drive power down completely before powering up with the UPS supply.</p>

Diagnostics and Troubleshooting

Error/Message	Alt. / (NUM)	Description	Cause/Solution/Troubleshoot
Error Encoder1	EEnC1 (32)	Loss of incremental encoder channel or differential pair are the same for TTL encoders.	<p>For an incremental encoder interface , the recognition of encoder channel breakage or defective track triggers a fault if the voltage between two signal pairs (A+/A-, B+/B-, N+/N-) is smaller than 2V. That is, a signal pair cannot be at the same level. Channel pair voltages can be measured to confirm.</p> <p>If an incremental encoder does not have N+/N- (or Z+/Z-) tracks, then the corresponding inputs on the encoder interface card must be jumpered high/low. That is, jumper X3A.5 (N+) to X3B.7 (+5V) and X3A.6 (N-) to X3A.8 (0V Common). In any case, the N+/N- are not needed and these inputs could always be jumpered high/low.</p> <p>If performing a Motor Learn in open-loop, the incremental encoder interface card could be removed if an encoder is not connected.</p> <p>Verify the encoder power ratings & connections (e.g. Powering a 8-30VDC rated encoder with 5V)</p> <p>During a Pole Position Learn for a PM motor, the correct direction was not detected indicating that either the direction was incorrect due to the A/B channel phasing or that movement did not occur either due to excessive friction, brake not lifting, etc.</p> <p>If the encoder A/B phasing is incorrect during the Pole Position Learn for a PM motor, this can be changed in LE03 Swap Encoder Channels. This is automatically done during the Encoder Synchronization procedure.</p> <p>During the Pole Position learn, the motor must be able to move with little friction which may require either a balanced car or unroped sheave. Additionally, verify the brake is picking and fully released.</p>
Error Encoder Card	EHyb (52)	Invalid encoder interface identifier	<p>Check for correct encoder connections/pinout. Incorrect pinout may drag the encoder board power supply down.</p> <p>Check encoder card connection to control board for bent or missing pins and proper connection.</p> <p>Otherwise, the board may be defective and should be replaced.</p>

Error/Message	Alt. / (NUM)	Description	Cause/Solution/Troubleshoot
Error Encoder Card Changed	EHybC (59)	Indicates the encoder interface card has been changed.	This error should automatically clear itself. If not, re-Enter the read-only setting in parameter LE01.
Error Encoder Interface	EENCC (35)	Loss of encoder channel or communication between encoder and drive for an absolute encoder.	This error should be accompanied with further information describing the nature of the fault. Refer to LE12 Serial Encoder 1 Status for further details.
Error External Fault	EEF (31)	An digital input can be programmed to trigger an error.	<p>The digital input for an External Fault may come from the controller or may be jumpered from an inverter or regen digital output. The cause of the error will be variable.</p> <p>Identify the source of the External Fault input and the conditions which would trigger this input.</p>
Error HSP5 Serial Com. (EBus)	EBus (18)	This message indicates that serial communication between the keypad operator and the drive or the drive and the elevator control has been lost (See parameter LX09 Ser.Com Watchdog Time to bypass this fault).	<p>Verify keypad operator is seated properly to the inverter.</p> <p>Verify connection of the serial comm. to the keypad operator at port X6C.</p> <p>Verify there are no bent or missing pins where the serial comm. cable from the controller plugs into the keypad operator.</p> <p>Verify serial comm. between controller and drive.</p> <p>Verify connection of keypad operator and inverter control card.</p> <p>Verify there are no bent or missing pins where the keypad operator connects to the control card.</p>
Error Initialization MFC	EInI (57)	Control card processor unable to boot.	Replace control card.

Diagnostics and Troubleshooting

Error/Message	Alt. / (NUM)	Description	Cause/Solution/Troubleshoot
Error Low Motor Current	Ebr (56)	<p>Error current check.</p> <p>Prior to every run the drive sends current to each phase of the motor to verify the connection. Afterward, the drive applies magnetizing current (Induction Motors) and monitors whether the motor is magnetized or not.</p>	<p>Possible causes for low motor current error during current check:</p> <p>Motor contactor contacts are burnt or damaged.</p> <p>Bypass motor contactor (do not simply jumper!) to test and replace as needed.</p> <p>One or more motor leads is not connected.</p> <p>Motor contactor is not closing or not closing in time</p> <p>Bypass motor contactor or verify switching time.</p> <p>Motor windings are damaged.</p> <p>Measure motor resistance.</p> <p>The phase current check can be bypassed by setting LX08 = Magnetizing Current Check (Induction Motors only).</p>
Error Low Speed Overload	EOL2 (19)	<p>Occurs if the low frequency, standstill constant current is exceeded (see Technical Data for stall current levels and overload characteristics).</p> <p>The error can only be reset if the cooling time has elapsed and E.nOL2 is displayed.</p>	<p>The cause of the Low Speed Overload would be due to excessive current at low speed (typically below 3Hz). The following may be causes of excessive current:</p> <p>Incorrect motor data.</p> <p>Verify motor data, specifically the motor rated speed and frequency relationship for PM Synchronous Motors (see Section 5.5.2, LM02 or LM04 for details).</p> <p>Verify correct encoder settings including:</p> <p>LE02 Encoder Pulse Number</p> <p>LE03 Swap Encoder Channels (A/B setting)</p> <p>LE06 Encoder Pole position for PM Synchronous Motors. Relearn Encoder Pole Position as needed (see Section 5.10.1 or 5.10.2).</p> <p>High mechanical load/issues (friction).</p>

Error/Message	Alt. / (NUM)	Description	Cause/Solution/Troubleshoot
Error Motor Overheat	EdOH (9)	The external motor temperature sensor tripped.	<p>If a motor PTC temperature sensor, relay, or KTY (special hardware required) is connected to terminals T1, T2 and the motor overheat function LX10 EdOH Function = On, then if the PTC resistance exceeds 1650 Ohms, relay opens, or the KTY sensor is above the set value in LM10 Motor Overload temp, then a motor overheat is detected.</p> <p>Cause of excessive motor heating may include:</p> <ul style="list-style-type: none"> Excessive current. Verify correct motor data. Verify correct encoder settings including: <ul style="list-style-type: none"> LE02 Encoder Pulse Number LE03 Swap Encoder Channels (A/B setting) LE06 Encoder Pole position for PM Synchronous Motors. High mechanical load/issues (friction). Insufficient motor cooling.

Diagnostics and Troubleshooting

Error/Message	Alt. / (NUM)	Description	Cause/Solution/Troubleshoot
Error Motor Protection	EOH2 (30)	Electronic Motor Overload protection was activated.	<p>Excessive RMS motor current according to the LM08 Electric Motor Protection overload curve or if the LM11 Peak Motor Current Factor is exceeded for more than 3 seconds for PM Synchronous Motors.</p> <p>For induction motors the baseline current for Electric Motor Protection corresponds to the LM09 Electric Motor Overload Current.</p> <p>For PM Synchronous Motors the baseline current for Electric Motor Protection corresponds to the LM03 Motor Current and the Peak Motor Current Factor is LM11.</p> <p>Causes of excessive RMS current would be:</p> <p>Incorrect motor data.</p> <p>Verify motor data, specifically the motor rated speed and frequency relationship for PM Synchronous Motors (see Section 5.5.2, LM02 or LM04 for details).</p> <p>Verify correct encoder settings including:</p> <p>LE02 Encoder Pulse Number</p> <p>LE03 Swap Encoder Channels (A/B setting)</p> <p>LE06 Encoder Pole position for PM Synchronous Motors. Relearn Encoder Pole Position as needed (see Section 5.10.1 or 5.10.2).</p> <p>High mechanical load/issues (friction).</p>

Error/Message	Alt. / (NUM)	Description	Cause/Solution/Troubleshoot
Error Over Current	EOC (4)	Occurs when the specified peak output current is exceeded or if there is a ground fault.	<p>The current and peak current may be viewed in Diagnostic Screen #1 or DG06 and DG31. To reset the logged peak value, press the F4 Reset key from the Diagnostic Screen.</p> <p>Causes for over current errors:</p> <p>If the error occurs instantly at the start of each run, the issue may be:</p> <ul style="list-style-type: none"> Ground fault on motor leads. Damaged or slow to close motor contactor. Shorted output transistor. Motor failure. <p>If the error is intermittent, the issue may be due to:</p> <ul style="list-style-type: none"> Damaged or slow to close motor contactor. Loose motor connections. Electrical noise, faulty grounding. <p>To determine if the over current is caused by the inverter, motor, or intermediate component (e.g. motor contactor), systematically remove these items from the system.</p> <p>Start by bypassing the motor contactor (do not simply jumper !).</p> <p>Checking of the motor and motor cables for short circuits or opens:</p> <p>Resistance checks should be done with the motor disconnected from the inverter. With the motor cable disconnected from the inverter, make a resistance check from phase to phase. This should read the winding resistance, as specified by the motor manufacture. Phase to ground resistance should read an open circuit. If measurements indicate a fault, disconnected cables at motor side and remake the test to determine if the fault is with the motor or cabling.</p> <p>...continued on next page.</p>

Diagnostics and Troubleshooting

Error/Message	Alt. / (NUM)	Description	Cause/Solution/Troubleshoot
Error Over Current (continued)	EOC (4)		<p>Meg tests to check motor winding insulation can only be performed with the motor disconnected from the inverter. Failure to do so will result in damage to the output section of the inverter due to high voltage from the meg tester.</p> <p>The inverter can be operated in open loop induction mode without being connected to the motor:</p> <p>Power off and after appropriate discharge time, disconnect the motor leads from the inverter.</p> <p>If not an induction motor, change motor configuration to induction motor in US03 (if US03 was previously set to a PM synchronous motor, performing this step will erase and default all parameters; make note of settings as needed before continuing), then Write Configuration to Drive in US05. Program drive as needed from default for the drive to output current when given an inspection run command.</p> <p>Set to LC01 Control Mode = Open Loop V/Hz</p> <p>Run the system with the motor leads disconnected in open-loop. If the over current error occurs, then the inverter output is faulty. If an overcurrent error does not occur, then the fault may be in the motor, motor cabling or motor contactor.</p> <p>If the over current error stays with the inverter, then one of the outputs may be shorted. See Appendix for diode check measurements of inputs and outputs.</p> <p>Notes:</p> <p>Under normal operation, the drive would limit the output to the current corresponding to the maximum torque in LC30. Maximum Output Current $x = LC03$ Motor Current $x LC30$ Maximum Torque.</p> <p>The drive would also limit the output current to the hardware current limit, listed as the Peak Current (30sec.) rating in the Technical Data tables in Sec.2.4 and 2.5. The Peak Current rating will be less than the overcurrent.</p>

Error/Message	Alt. / (NUM)	Description	Cause/Solution/Troubleshoot
Error Overheat Power Module	EOH (8)	The heat sink temperature rises above the permissible limit.	<p>The heatsink temperature can be viewed in Diagnostics Screen #7 or DG37. The overheat limit is 90 degrees Celsius for most drives (See Technical Data for units 175HP and larger). Under normal operation, the heatsink temperature should usually be below 65 degrees Celsius.</p> <p>Causes of inverter heatsink overheat include:</p> <ul style="list-style-type: none"> Insufficient cooling or ambient temperature too high Verify operation of fans. <ul style="list-style-type: none"> The fans are thermostatically controlled to come on at about 45 degrees Celsius. To turn all fans on high, LX06 Function Test can be set to Fans On. Make sure fans are not clogged. Increase airflow around inverter or add cabinet fans. Faulty temperature sensor. <ul style="list-style-type: none"> Power down the inverter or let it to stand idle to allow for the heatsink temperature to cool. If the heatsink temperature read by the drive for the diagnostics seems unreasonably high for a heatsink cool to the touch, then the heatsink temperature sensor may be faulty and would need to be repaired by KEB.

Diagnostics and Troubleshooting

Error/Message	Alt. / (NUM)	Description	Cause/Solution/Troubleshoot
Error Overload	EOL (16)	<p>Time dependent overload (See overload curves under Technical Data, Section 2.9).</p> <p>Error can not be rest until display shows E.nOL!</p>	<p>Cause of excessive motor overload may include:</p> <ul style="list-style-type: none"> Excessive current. Verify correct motor data. Verify correct encoder settings including: <ul style="list-style-type: none"> LE02 Encoder Pulse Number LE03 Swap Encoder Channels (A/B setting) LE06 Encoder Pole position for PM Synchronous Motors. High mechanical load/issues (friction).

Error/Message	Alt. / (NUM)	Description	Cause/Solution/Troubleshoot
Error Overspeed	EOS (58)	The internal overspeed limit is exceeded.	<p>The inverter internal overspeed is dictated as 110% of the US06 Contract Speed. This level is fixed and cannot be adjusted, except for when performing the Overspeed Test function (refer to parameters LL15, LL16 for further information).</p> <p>Possible causes of an overspeed error include:</p> <p style="padding-left: 40px;">Incorrect setting of the Machine Data parameters LN01-03.</p> <p style="padding-left: 40px;">The Machine Data parameters are used as a scalar to convert a linear speed (e.g. ft/min) to a rotary speed (rpm) used by the inverter. If the machine data is not set correctly, the overspeed limit may be calculated too low when control modes which dictate the drive speed exceed this limit (e.g. it is possible in Serial Speed control mode for the controller to command a speed higher than the overspeed error limit calculated from the machine data parameters, which could cause inadvertent overspeed error).</p> <p>Lack of control</p> <p style="padding-left: 40px;">Maximum Torque limit or peak inverter current reached.</p> <p style="padding-left: 40px;">Monitor the motor current to see if it reaches a current corresponding to the LC30 Maximum Torque or the drive Peak Current rating.</p> <p style="padding-left: 40px;">Maximum Torque may be set too low (default = 150%; Typical for high speed/full load operation = 200-250%)</p> <p style="text-align: right;">...continued on next page...</p>

Diagnostics and Troubleshooting

Error/Message	Alt. / (NUM)	Description	Cause/Solution/Troubleshoot
Error Overspeed (continued)	EOS (58)		<p>Excessive current</p> <p>Incorrect motor data, specifically the motor rated speed and frequency relationship for PM Synchronous Motors (see Section 5.5.2, LM02 or LM04 for details).</p> <p>Incorrect Encoder Pole Position for PM Synchronous Motors. Relearn Encoder Pole Position as needed (see Section 5.10.1 or 5.10.2</p> <p>Speed gains set too high or low.</p> <p>For an unloaded PM Synchronous Motor, then default speed gains LC03-12 may be too high, causing the machine to jerk quickly. If left too low for normal operation, the drive may not track the speed.</p> <p>Modulation gain exceeds maximum.</p> <p>If the modulation grade in Diagnostic Screen #2 or DG10 exceeds 100% there may be a loss of speed control.</p> <p>Sudden, excessive movement.</p> <p>Incorrect motor data, specifically the motor rated speed and frequency relationship for PM Synchronous Motors (see Section 5.5.2, LM02 or LM04 for details).</p> <p>Incorrect Encoder Pole Position for PM Synchronous Motors. Relearn Encoder Pole Position as needed (refer to Section 5.10.1 or 5.10.2).</p>

Error/Message	Alt. / (NUM)	Description	Cause/Solution/Troubleshoot
Error Over Voltage	EOP (1)	<p>The DC bus voltage rises above the permissible value either during motor regenerative operation or as a result of line side voltage spikes.</p> <p>For 460V drives, the over voltage level is 800VDC and for 230V drives, the over voltage level is 400VDC.</p> <p>The over voltage level cannot be adjusted.</p>	<p>The DC bus voltage DG08 and the peak DC bus voltage can be monitored in the Diagnostic screen #1 or DG08 and DG30. To reset the logged peak value, press the F4 Reset key from the Diagnostic Screen.</p> <p>When using a braking resistor to dissipate regenerated energy from overhauling or deceleration, the braking resistor should come on at the following levels:</p> <p style="text-align: center;">460V = 760VDC 230V = 380VDC</p> <p>If a braking resistor is used:</p> <p style="padding-left: 40px;">Ensure proper connection of the braking resistor to the to the braking transistor terminals PB, ++.</p> <p style="padding-left: 40px;">Disconnect braking resistor and measure resistance to verify if correct.</p> <p>If a line regen unit is used:</p> <p style="padding-left: 40px;">By default, the line regen unit will turn on at 103% of the idle DC bus voltage.</p> <p style="padding-left: 40px;">Ensure proper connection between the drive and regen unit at the ++ and - - terminals at both units.</p> <p style="padding-left: 40px;">Ensure the regen unit is regenerating properly and is in the regen status when it should be and there no faults on the regen unit preventing operation.</p> <p>If the over voltage is due to transient voltage spikes from the line:</p> <p style="padding-left: 40px;">Install a 3-5% line reactor</p> <p>If the over voltage is due to high line voltage:</p> <p style="padding-left: 40px;">Step-down down the line voltage with a transformer.</p> <p>If there is an issue with the DC bus voltage measurement circuit:</p> <p>...continued on next page.</p>

Diagnostics and Troubleshooting

Error/Message	Alt. / (NUM)	Description	Cause/Solution/Troubleshoot
Error Over Voltage (continued)	EOP (1)		<p>Measure DC bus directly and verify against DC bus voltage read from the Diagnostics screen. The DC bus should be approximately 1.41xAC Input phase-to-phase.</p> <p>If a braking resistor is used and there is an issue with the braking transistor:</p> <p>Test Braking Transistor measurement (See Appendix)</p> <p>If there is an issue due to high frequency noise:</p> <p>Verify proper mains grounding.</p>
Error Power Unit	EPU (12)	General power circuit fault	Inverter must be inspected and repaired by KEB or replaced.
Error Power Unit Changed	EPuch (50)	The control card recognizes a new power stage (the control card was changed).	This error should automatically clear itself.
Error Power Unit Invalid	EPuci (49)	During the initialization the power circuit could not be recognized or was identified as invalid	<p>This error could occur from noise.</p> <p>Disconnect terminal strip, encoder cable and serial comm. (if used) and power cycle the drive.</p> <p>Check phase-to-phase and phase-to-ground line voltages to make sure they are balanced and not causing noise.</p> <p>Re-seat ribbon connecting control card to power stage.</p>
Error Serial Command Speed*	- (166)	Serial speed command not present at the beginning of a run.	When US04 = Serial Speed DIN66019 Serv. 49 (4) or Serial Speed DIN66019 Serv. 50 (5), the serial speed command must be received within $t=2.5(LT01+LT03)$ sec. at beginning of run. Refer to additional information at end of section.

Error/Message	Alt. / (NUM)	Description	Cause/Solution/Troubleshoot
Error Under Voltage	EUP (2)	<p>The DC bus voltage drops below the permissible value.</p> <p>For 460V drives, the under voltage level is 240VDC and for 230V drives, the under voltage level is 216VDC.</p> <p>The under voltage level cannot be adjusted.</p>	<p>Causes for under voltage include:</p> <p>Input voltage too low or unstable.</p> <p>Verify input voltage and wiring. The DC bus should measure approximately 1.41 x AC Input phase-to-phase and should match the DC bus measurement by the drive in the Diagnostics Menu.</p> <p>One phase of the line input is missing.</p> <p>Line input phases are imbalanced. The phase-to-phase voltage measurement should not exceed 2%.</p> <p>Isolation transformer undersized or wired incorrectly.</p> <p>If there is an issue with the DC bus voltage measurement circuit:</p> <p>Measure DC bus directly and verify against DC bus voltage read from the Diagnostics screen. The DC bus should be approximately 1.41xAC Input phase-to-phase.</p> <p>Note: A 460V drive can operate on a 230V, single phase power supply if programmed for UPS mode operation.</p>
ESD Input Failure*	- (160)	ESD input missing.	When an input programmed as ESD (Emergency Slowdown) in LI04-11 is not present (high) at the beginning of run. Refer to additional information at end of section.
ETS Input Failure*	- (154)	ETS input missing.	When an input programmed as ETS (Emergency Terminal Slowdown) in LI04-11 is not present (high) at the beginning of run. Refer to additional information at end of section.
Main Contact Failure*	- (150)	Motor contactor not closed	When an input programmed as Main Contactor Check in LI04-11 not present (high) at the beginning of run. Refer to additional information at end of section.
no Error Low Speed Overload	nEOL2 (20)	No more overload.	Low speed overload has cleared and can be reset.

Diagnostics and Troubleshooting

Error/Message	Alt. / (NUM)	Description	Cause/Solution/Troubleshoot
no Error Motor Overheat	nEdOH (11)	Over temperature reset possible	Motor overheat sensor reset and Error Motor Overheat can be reset.
no Error Overload	nEOL (17)	No more overload.	Overload counter has reached 0%, allowing motor to cool and the error overload error may be reset.
Power Unit Not Ready	no_PU (13)	Control card is powered up, but the power stage is not and not seen by control card.	<p>The Power Unit Not Ready message may occur due to the following conditions:</p> <p>Control card powered up by external power supply, but drive is not powered up by line. Since the drive is not being powered by the line, the power stage cannot be identified.</p> <p>Connection issue between control card and power stage.</p> <p>For inverter housing sizes G, H, R, U, remove then reconnect the ribbon cable connecting the control card to the power stage at the control card connection.</p> <p>For inverter housing sizes D, E, remove the control card then re-seat, ensuring pin connections.</p> <p>Switching power supply.</p> <p>If reseating the ribbon cable does not resolve the issue, then there may be a failure of the switching power supply and the drive would need to be replaced or inspected and repaired by KEB.</p>

Error/Message	Alt. / (NUM)	Description	Cause/Solution/Troubleshoot
Speed Following Error	- (152)		<p>The encoder speed deviates from the command speed by more than the amount set in LX14 Speed Difference for more than 1 second (fixed). The Speed Following Error can be ignored as a drive fault by setting LX13 Speed Following Error = Warning - Digital Output (if any of the outputs LO05, 10, 15, or 20 are set for At Speed, the controller may still generate a fault).</p> <p>Possible causes of a speed following error include:</p> <ul style="list-style-type: none"> Lack of control <ul style="list-style-type: none"> Maximum Torque limit or peak inverter current reached. <ul style="list-style-type: none"> Monitor the motor current to see if it reaches a current corresponding to the LC30 Maximum Torque or the drive Peak Current rating. <ul style="list-style-type: none"> Maximum Torque may be set too low (default = 150%; Typical for high speed/full load operation = 200-250%) Excessive current <ul style="list-style-type: none"> Incorrect motor data, specifically the motor rated speed and frequency relationship for PM Synchronous Motors (see Section 5.5.2, LM02 or LM04 for details). Incorrect Encoder Pole Position for PM Synchronous Motors. Relearn Encoder Pole Position as needed (refer to Section 5.10.1 or 5.10.2). <p>...continued on next page.</p>

Diagnostics and Troubleshooting

Error/Message	Alt. / (NUM)	Description	Cause/Solution/Troubleshoot
Speed Following Error (continued)	- (152)		<p>Speed gains set too low.</p> <p>If the speed following error occurs during acceleration or deceleration, the speed tracking may lag if the speed control gains are too low.</p> <p>Increase corresponding proportional speed gain for acceleration or deceleration.</p> <p>Learn system inertia.</p> <p>If the speed following error occurs at takeoff, there may be high break away friction.</p> <p>Increase LC11 KI Speed Offset Acceleration.</p> <p>Mechanical Issues/High Friction.</p> <p>Modulation gain exceeds maximum.</p> <p>If the modulation grade in Diagnostic Screen #2 or DG10 exceeds 100% there may be a loss of speed control. This may also prevent the motor from reaching the command speed.</p>
Speed Selection Error*	- (153)	Speed command input missing at beginning or run.	For digital input speed select control modes, the amount of time at the beginning of a run after Drive Enable and Direction command before the Speed Selection Error is triggered if a speed input is not given in the amount of time $t=LT01+LT03$ seconds.. Refer to additional information at end of section.
Unintended Movement*	- (158)	After a normal high speed run, if the motor moves by more than +/- 50mm then Unintended Movement will occur and can only be reset manually by pressing F1 and F4 simultaneously on the keypad.	<p>Unintended Movement is not monitored from inspection speed selection. For analog and serial speed control modes, an input can be programmed to indicate inspection runs.</p> <p>Refer to additional information at end of section.</p>

Analog Signal Failure

The Analog Signal Failure event will occur when no speed command is given within a certain time period at the beginning of a run with external profile pattern generation US04 Control Type = Analog (2,3) modes.

The timer is defined as:

$$\begin{aligned} t &= 2.5 \times (LT01 + LT03) \\ &= 2.5 \times (\text{Brake Release Delay} + \text{Speed Start Delay}) \end{aligned}$$

$$\text{Default} = 2.5 \times (0.05\text{s} + 0.70\text{s}) = 1.875\text{s}$$

Maximum: 3.00 seconds

If a speed command is detected during the LT03 Speed Start Delay, the timer will automatically expire from the phase of the profile where pretorque speed control gains (LC05, 10) active to the acceleration phase (LC03, 08, 11).

Brake Switch Failure

When a digital (LI04-11) or serial (Fb21-27) input is programmed for Brake Release Confirmation (18), the drive checks if the brake opens or closes within a set amount of time. The timers are defined as:

Starting:

$$\begin{aligned} t &= LT01 + LT03 + 2.5 \\ &= \text{Brake Release Delay} + \text{Speed Start Delay} + 2.5\text{s} \end{aligned}$$

$$\text{Default} = 0.05\text{s} + 0.70\text{s} + 2.5\text{s} = 3.25\text{s}$$

Stopping:

$$\begin{aligned} t &= LT10 + LT12 \\ &= \text{Brake Drop Delay} + \text{Current Hold Time} \end{aligned}$$

$$\text{Default} = 0.10\text{s} + 0.50\text{s} = 0.60\text{s}$$

Two inputs can be programmed for the brake switch. During stop, the switches should be closed and open during run. If the brake switch is open during the Idle Mode, then the Brake Switch Failure event will also occur. If during the run, the brake switch closes, the Brake Switch Failure event will not occur.

Diagnostics and Troubleshooting

Direction Selection Failure

The Direction Selection Failure will occur if both direction inputs are signaled when the Drive Enable is initially signaled at the beginning of a run.

Drive Enable Dropped

Whenever the drive enable is drop, output current will instantly be shut off. If the drive enable is dropped any time during the course of a normal run a Drive Enable Dropped event is logged.

A normal run is considered any run profile that is not inspection. A Drive Enable Dropped event will not from an inspection run.

- For US04 Control Type = Binary Speed (1), Digital Speed (0) Selection, or Serial Binary Speed DIN66019 Serv. 50 (6), the speed signaled for inspection speed must match the corresponding inspection speed according to the LI03 Speed Input Decoding.
- For US04 Control Type = Serial or Analog, a run is considered an inspection run when the digital input (LI04-11) programmed as Inspection Speed (32) is on for the length of the entire run.

If a Drive Enable Dropped event occurs, a potential ensuing Unintended Movement event will not be logged.

ESD/ETS Input Failure

When a digital (LI04-11) or serial (Fb21-27) input is programmed for Emergency Slowdown (ESD) or Emergency Terminal Slowdown (ETS), the input must be active at the start of a run, otherwise an ESD or ETS Input Failure event will occur.

Main Contact Failure

When a digital (LI04-11) or serial (Fb21-27) input is programmed for Main Contactor Check (19), the drive checks for the signal that the contactor has closed at the beginning of a run. If not, the Main Contact Failure event will occur.

Serial Speed Command Failure

The Serial Speed Command Failure event will occur when no speed command is given within a certain time period at the beginning of a run with external profile pattern generation US04 Control Type = Serial (4,5) modes.

The timer is defined as:

$$\begin{aligned} t &= 2.5 \times (LT01 + LT03) \\ &= 2.5 \times (\text{Brake Release Delay} + \text{Speed Start Delay}) \end{aligned}$$

$$\text{Default} = 2.5 \times (0.05\text{s} + 0.70\text{s}) = 1.875\text{s}$$

Maximum: 3.00 seconds

If a speed command is detected during the LT03 Speed Start Delay, the timer will automatically expire from the phase of the profile where pretorque speed control gains (LC05, 10) active to the acceleration phase (LC03, 08, 11).

Speed Selection Error

The Speed Selection Error event will occur when no speed command input is given within a certain time period at the beginning of a run with US04 Control Type = Binary Speed (1), Digital Speed (0), or Serial Binary Speed (6). The speed inputs must be selected during the expiration of the LT01 + LT03 timers. Toggling the speed before this does not reset the timer and does not have any effect; the speed command must be present at the expiration of the timers.

The timer is defined as:

$$\begin{aligned} t &= LT01 + LT03 \\ &= \text{Brake Release Delay} + \text{Speed Start Delay} \end{aligned}$$

$$\text{Default} = 0.05\text{s} + 0.70\text{s} = 0.75\text{s}$$



The default settings for programmable digital inputs (LI04-11) is No Function (Off). Likewise, for Serial Binary Speed control (US04 = 6) the (Fb21-27) serial inputs are also set as No Function (Off) by default. The inputs must be assigned accordingly for Speed Selection (27).

Diagnostics and Troubleshooting

Unintended Movement

The Unintended Movement event occurs when the difference between the motor position during idle after a normal run changes by 50mm (1.96 inches). The event is logged and requires a forced reset.

A normal run is considered any run profile that is not inspection. An Unintended Movement event will not occur after an inspection run.

- For US04 Control Type = Binary Speed (1), Digital Speed (0) Selection, or Serial Binary Speed DIN66019 Serv. 50 (6), the speed signaled for inspection speed must match the corresponding inspection speed according to the LI03 Speed Input Decoding.
- For US04 Control Type = Serial or Analog, a run is considered an inspection run when the digital input (LI04-11) programmed as Inspection Speed (32) is on for the length of the entire run.

After a normal run, a comparison level is determined after the Brake Control output conditions have set and the Enable input has been dropped. During idle until the next normal run, the motor position is compared against this level for 50mm (1.96 inches) maximum before an Unintended Movement event occurs. The window of comparison is fixed and the function cannot be turned off. The Elevator Position can be monitored in Diagnostics Screen #10 or DG04. Since the motor position is determined from the motor encoder, movement of the elevator car itself from rope stretch, etc., would not cause an Unintended Movement event.

Once an Unintended Movement event has occurred, a forced reset is required by simultaneously pressing the F1 and F4 hotkeys on the keypad operator. The event cannot be cleared by signaling the reset on the drive or cycling power.

If the cause of unintended movement is from the drive enable being dropped, then a Drive Enable Dropped event will occur instead of Unintended Movement.

7.3 Operation Problems

Troubleshooting Operation Problems and potential solutions. Refer to Section 7.4 for additional Diagnostics Solutions. Additional troubleshooting of learn procedures are listed as well at the end of this section.

Problem	Cause/Solution/Troubleshoot
<p>Motor Does Not Move</p>	<p>Check the Motor Current. Refer to Motor Draws High Current for additional troubleshooting.</p> <p>Make sure the brake is picking and/or not dragging.</p> <p>Check the Inverter Status to determine whether there is indication a run command is being given (i.e. Up/Down Constant Speed/Acceleration/Deceleration, etc.).</p> <p>Check Input Status to determine whether the correct inputs are being signaled for a run command.</p> <p>Check the Command Speed to determine what the dictated speed command is.</p> <p>Check the Active Speed and Active Profile to determine what speed setting is being selected.</p> <p>For digital inputs, check setting of the selected Active Seed or Active Profile.</p> <p>For analog speed commands, check the Raw and Processed (Analog) Patterns, the High Speed setting, and speed settings for any Active Profile.</p> <p>Check to make sure the speed control gains (KP, KI Offset) are not set too low.</p> <p>For open loop induction motors, the the Low Speed Torque Boost may need to be increased to lift the load or decreased if either the Maximum Torque of Inverter Peak Current limit is reached.</p>

Diagnostics and Troubleshooting

Problem	Cause/Solution/Troubleshoot
Motor Draws High Current	<p data-bbox="500 197 857 226">Verify correct motor data.</p> <p data-bbox="532 275 1443 380">For PM motors, verify the correct relationship between the Motor Rated Speed, Motor Rated Frequency and the number of motor poles. Refer to the text for further description.</p> <p data-bbox="500 428 1373 457">Perform a Motor Learn if this has not already been completed.</p> <p data-bbox="500 506 1479 646">For PM motors, verify the encoder/motor pole position is correct. Make note of the present LE06 Encoder Pole Position value and relearn as needed. Refer to Encoder slippage/mounting (PM motors) for additional information.</p> <p data-bbox="500 695 1507 842">For PM motors, the encoder channel A/B phasing (LE03 Swap Encoder Channels) must be correct and the encoder/rotor position learned with the correct setting. The correct A/B phasing can be determined by the LL07 Encoder Synchronization procedure.</p> <p data-bbox="500 890 1443 995">For induction motors, set LC01 Control Mode to Open Loop V/Hz to determine if the issue is due to encoder, encoder settings or speed control settings.</p> <p data-bbox="500 1043 1511 1106">For open loop induction motors, the Low Speed Torque Boost may need to be decreased or increased.</p> <p data-bbox="500 1155 1503 1218">Verify the brake picks and does not drag and that there are no other mechanical issues preventing the motor from rotating freely.</p>

Problem	Cause/Solution/Troubleshoot
Encoder slippage/mounting (PM motors)	<p>The position of the rotor must be known for synchronous (PM) motors for the drive to properly commutate the stator magnetic field and generate torque. Performing a encoder/rotor position learn (LL05 SPI or LL06 Encoder Pole Position Learn) determines a corresponding encoder position offset value for a given rotor position. The encoder is a mechanical extension of the rotor and therefore acts as an electrical commutator.</p> <p>If the mechanical relationship (eg. mounting) between the motor and encoder changes (eg. slippage), the position information from the encoder does not accurately reflect the actual rotor position resulting in the actual commutation angle being incorrect.</p> <p>When the commutation angle is not correct, more current is required to produce a given amount of torque. Large enough changes will result in very high current draw and low torque production. This leads to the motor being unable to move (stalling) or unable to hold the load (movement in direction of load, eg. empty car counterweights pull car up). In this case, the current is often reaching the corresponding LC30 Maximum Torque limit or the peak current rating of the drive,</p> <p>If the encoder/rotor position is re-learned and determined to be different than the previous value of the LE06 Encoder Pole Position by more than 4,000 counts, then this is a clear indication that the mechanical relationship between the motor and encoder has changed.</p> <p>In most cases, encoder slippage has occurred or there is an encoder mounting issue. The accumulation of slippage may occur over distance (between a few inches of movement or the entire hoistway), over time (sometimes after several years of operation), or from a change in direction (sometimes due to loose encoder mounting).</p> <p>The suggested course of action would be to first inspect the encoder mounting (in many cases, the encoder may actually be mounted tight), remove the encoder and inspect again, and re-install the encoder then relearn the encoder position (it will be different than before the encoder was removed). If issues persist, re-learn the encoder/rotor position. If large difference between learns persist (it is important to move car between learns to accumulate slippage, if this is the issue), continue to inspect the motor and encoder for mounting issues.</p>

Diagnostics and Troubleshooting

Problem	Cause/Solution/Troubleshoot
<p>Motor does not go the correct speed or cannot reach high speed.</p>	<p>Check whether the Command Speed and Encoder Speed match (Home Screen or Diagnostics Screen #1). .</p> <p>Verify whether the Motor (Encoder) Speed is tracking the Command Speed.</p> <p>Check which Active Speed and/or Active Profile is selected.</p> <p>Check the speed setting for the corresponding Active Speed/Active Profile selected.</p> <p>Check whether the Machine Data parameters (LN) are set correct.</p> <p>Check whether the (Voltage) Modulation Grade is reaching 100%. Refer to Voltage Modulation Grade limited reached for further troubleshooting.</p> <p>Check whether the Maximum Torque Limit or Inverter Peak Current limit are being reached.</p> <p>Check if the speed control gains (KP Proportional, KI Integral Offset) are set too low.</p>
<p>Overshoot into floor</p>	<p>Check the motor current, whether the Maximum Torque Limit or Inverter Peak Current limit are being reached.</p> <p>Check whether the Motor (Encoder) Speed is tracking the Command Speed.</p> <p>Check if the speed control gains (KP Proportional, KI Integral Offset) are set too low. Raise as needed.</p>
<p>Cannot lift full load</p>	<p>Check the motor current, whether the Maximum Torque Limit or Inverter Peak Current limit are being reached. Refer to Motor Draws High Current for additional troubleshooting.</p> <p>Check if the speed control gains (KP Proportional, KI Integral Offset) are set too low.</p> <p>For open loop induction motors, the Low Speed Torque Boost may need increased or decreased if reaching the Maximum Torque Limit or Inverter Peak Current.</p>

Problem	Cause/Solution/Troubleshoot
Motor only moves one direction; direction of weighting (e.g. counterweights pulling up for empty car)	<p>Check the motor current. Refer to Motor Draws High Current for additional troubleshooting.</p> <p>Check the Command Speed for dictated speed direction and whether it changes between directions.</p>
Motor only moves slightly or jerks briefly	<p>Check the motor current. Refer to Motor Draws High Current for additional troubleshooting.</p> <p>Refer to Motor Does Not Move for additional troubleshooting.</p>
Output current is limited (clamped)	<p>Check the setting for Maximum Torque. Refer to Peak current limit or Maximum Torque limit reached for additional troubleshooting.</p> <p>Verify the current is not being limited by the Inverter Peak Current Limit. Refer to Peak current limit or Maximum Torque limit reached for additional troubleshooting.</p> <p>Check if motor current is excessive. Refer to Motor Draws High Current for additional troubleshooting.</p>
Maximum Torque limit or Peak Current limit reached.	<p>Check the setting for Maximum Torque. For full load and/or high speed automatic operation, this value should be in the range of 200-250%.</p> <p>Note, anytime any motor data parameters are changed or re-entered, the Maximum Torque LC30 will automatically be reset to 150% !</p> <p>Note, anytime a drive and keypad operator are synchronized the Maximum Torque LC30 will automatically be reset to 150% !</p> <p>Verify the current is not being limited by the Inverter Peak Current Limit.</p> <p>Check if motor current is excessive. Refer to Motor Draws High Current for additional troubleshooting.</p>

Diagnostics and Troubleshooting

Problem	Cause/Solution/Troubleshoot
Motor noise (Vibration)	<p>Increase the Sample Rate for Encoder (LE04) from 4ms (default) to 8ms.</p> <p>Verify correct motor data and whether motor learn has been performed.</p> <p>Reduce speed control gains (KP Proportional, KI Integral, KI Offset). Note, the default settings for an unroped PM motor may be too high.</p> <p>For induction motors, set the LC01 Control Mode to Open Loop V/Hz. If the issue is still present, then it is a mechanical issue.</p> <p>Check whether the (Voltage) Modulation Grade limit is being reached (100% or above). Refer to Voltage Modulation Grade limited reached for further troubleshooting.</p>
Motor noise (squealing/grinding sound), but not vibration; does not affect ride quality	<p>Check whether the Sample Rate for Encoder (LE04) is too high or too low; 4-8ms is typical.</p> <p>Check whether the setting for Encoder Multiplier Factor (LE05) is correct. For TTL incremental encoder, this value can only be set to a value of 2; for absolute encoders (e.g. EnDat) typically found on PM motors, the setting should be a value of 8.</p> <p>Verify correct motor data. Re-enter as needed.</p> <p>Perform a motor data learn if not yet completed.</p>
Unable to run induction motor in open loop.	<p>For open loop induction motors, the Low Speed Torque Boost may need to be decreased or increased.</p> <p>Verify there are no mechanical issues preventing the motor from rotating freely.</p>

Problem	Cause/Solution/Troubleshoot
(Voltage) Modulation Grade limit Reached	<p>Verify correct wiring of the motor, in particular with motors which have multiple voltage winding arrangements (eg. dual rated 230/460V motors, wye-star/delta)</p> <p>For induction motors, reduce the Field-Weakening Corner LM22 to 60-40% of synchronous speed (720-480 rpm for 6-pole/60 Hz motor).</p> <p>For PM motor, check the current, particularly the peak current during acceleration. Refer to Motor Draws High Current for additional troubleshooting.</p> <p>Reduce the acceleration and jerk rates into high speed.</p> <p>Verify there is not excessive sag of the DC bus during acceleration.</p>
Motor turns in the wrong direction (both directions)	<p>Perform Encoder Synchronization procedure.</p> <p>Inverter directions via LE03. Note, do not change A-B settings (Not inverted/Swap A-B) to invert direction.</p> <p>For PM motors, do not change (U,V,W) motor phasing !</p>
Clunk at end of run after brake sets	<p>Verify drive enable input is not being dropped prematurely while drive is still outputting torque to motor.</p>
High peak current at either start or stop	<p>Check the brake timing such that the motor is not starting against the brake and that the brake is not stopping the load.</p> <p>For digital input speed control, the Speed Start Delay LT03 can be extended to prevent starting under the brake. For analog and serial speed controls, this may need adjustment on the controller.</p>

Diagnostics and Troubleshooting

7.4 Diagnostic Solutions

Typical solutions in reference to operational problems in section 7.3.

Item #	Check/Solution
<p>Monitor the Input Status to Determine Active Speed and/or Active Profile (digital input control modes)</p>	<p>For the given combination of inputs selected, verify which speed command is selected according to the Control Type (US04) and Special Input Functions (LI03). This should match the Active Speed (Diagnostics Screen #10). Verify the corresponding speed setting in the Speed Profile (LS) parameter group.</p> <p>In addition, monitor the status of inputs assigned as any special operation modes (e.g. Earthquake Speed, UPS/Battery Operation Speed, Emergency Power Speed) assigned to any inputs (LI04, 05, 11).</p>
<p>Determine the correct motor speed in rpm.</p>	<p>For a given command speed in FPM, the corresponding speed in rpm is calculated as:</p> <p>Digital Input Speed Commands: $\text{RPM} = (12 * \text{Roping Ratio} * \text{Gear Ratio} * \text{FPM}) / (\text{Sheave Diameter} * 3.14)$</p> <p>Analog Speed Control: $\text{RPM} = (\text{Processed Analog Pattern} * \text{High Speed} * 12 * \text{Roping Ratio} * \text{Gear Ratio} * \text{FPM}) / (\text{Sheave Diameter} * 3.14 * 100)$</p> <p>Refer to Analog I/O (LA) parameter group for calculation of Processed (Analog) Pattern from Raw (Analog) Pattern.</p>

Item #	Check/Solution
<p>Monitor the Command Speed and Motor (Encoder) Speed</p>	<p>If the Command Speed and Motor (Encoder) Speed match, but the elevator does not travel at the correct speed:</p> <p style="padding-left: 40px;">Check Active Speed and Active Profile from Diagnostics and check whether the corresponding speed setting in the LS parameters is correct. Refer to Monitor the Active Speed and Active Profile for additional info.</p> <p style="padding-left: 40px;">Ensure the Machine Data parameters LN01-03. Incorrect data may cause the elevator to run too fast or too slow. Refer to LN parameter descriptions for further information.</p> <p style="padding-left: 40px;">If the US04 Control Type is analog type, verify correct US06 Contract Speed and LS02 High Speed settings. US06 Contract Speed dictates the maximum setting for the LS02 High Speed and the LS02 High Speed dictates the speed corresponding to 10V.</p> <p style="padding-left: 40px;">If the US04 Control Type is analog type, verify the correct Raw and Processed (Analog) Patterns in Diagnostics Screen #5 as well as any Analog Pattern Gain in LA05.</p> <p>If the Command Speed and Motor (Encoder) Speed do NOT match:</p> <p style="padding-left: 40px;">See Check whether Maximum Torque setting is reached and high enough for normal operation.</p> <p style="padding-left: 40px;">See Check whether Inverter Maximum Current Limit is being reached.</p> <p style="padding-left: 40px;">See (Voltage) Modulation Grade limit Reached</p>
<p>Monitor the Active Speed and Active Profile (Diagnostic Screen #11)</p>	<p>The Active Speed will indicate which speed setting is selected according to the US04 Control Type and LI03 Special Functions.</p> <p>The Active Profile will indicate if any modes of operation (eg. UPS Operation, Earthquake, Emergency) corresponding to programmed input functions (LI04-11) are active. In the case of certain modes of operation, the maximum speed may be limited to a speed lower than that selected and show as the Active Speed (above).</p>

Diagnostics and Troubleshooting

Item #	Check/Solution
Verify correct Machine Data (LN) parameter settings.	<p>The Machine Data parameters are used as a scalar to translate the command speeds programmed in FPM to an rpm value used by the drive. Incorrect setting of the machine data parameters may cause the command speed in rpm to be too high or too low.</p> <p>For example, if a machine has a 1:1 roping ratio, then setting this value in the drive as 2 (:1) will cause the speeds to be calculated as twice as fast.</p> <p>If the Motor (Encoder) Speed matches the Command Speed (rpm), but the calculated Elevator Speed or the actual speed measured by hand tach (FPM) are slightly off, then the Machine Data can be adjusted slightly so the numbers agree. This would typically be done by adjusting the Gear Reduction Ratio (LN02) or the Traction Sheave Diameter (LN01).</p> <p>Refer to Determine the Correct Motor Speed in RPM for further details.</p>
Encoder/Motor Pole Position Incorrect	<p>For PM motors, the absolute encoder position indicates is used to properly indicate the position of the rotor. If the connection of the encoder to the motor shaft changes (removed/replaced, slippage, etc.), the absolute encoder position relative to the motor poles is no long valid and will require the position to be relearned. If the LE06 Encoder Pole Position has changed by more than 2,000 from the previous value, this indicates a change in physical position relation of the encoder to the rotor, generally due to encoder slippage over time (potentially distance or change in direction as well), mounting issues, or mechanical aspects.</p> <p>When the encoder/motor pole position is incorrect, the motor will tend to draw high current, hitting the LC30 Maximum Torque setting or Inverter Peak Current Limit, and tending to stall or only move in the direction of weighting.</p>
Motor Data Incorrect	<p>Check the motor data against the nameplate values and perform a LL01 Motor Tune if not previously completed.</p> <p>For PM motors, ensure the relationship between the motor rated speed, motor rated frequency and number for motor poles is correct in case of any nameplate rounding. Refer to the LM02 Motor Speed for further details.</p>

Item #	Check/Solution
<p>Check whether Maximum Torque setting is reached and high enough for normal operation.</p>	<p>The LC30 Maximum Torque is used to limit the output current to the motor. It is primarily to protect the motor from extreme or prolonged high currents, which may occur during initial setup or troubleshooting. The limiting current can be calculated as $LM07 \text{ Motor Torque} \times LC30 \text{ Maximum Torque (\%)} / LM03 \text{ Motor Current}$.</p> <p>Under normal operation, this will typically need to be set in the range of 200-250%.</p> <p>Anytime any of the LM Motor Data parameters are changed, the LC30 Maximum Torque will be reset to 150%. This may be too low for normal, automatic operation.</p> <p>Anytime a keypad operator and drive are synched, the LC30 Maximum Torque will be reset to 150%. This may be too low for normal, automatic operation.</p> <p>The maximum output current rating of the inverter will be the limiting factor, if reached. The LC30 Maximum Torque setting will not provide a current beyond the drive's peak rating.</p> <p>If the maximum torque limit is being reached, this may be due to:</p> <ul style="list-style-type: none"> Incorrect Motor Data. Refer to Motor Data Incorrect for additional information. Encoder Position Incorrect. Refer to Encoder/Motor Pole Position Incorrect Mechanical Issues (eg. Brake not releasing) <p>For open loop induction motors, the LC32 Low Speed Torque Boost may be too high or too low.</p>

Diagnostics and Troubleshooting

Item #	Check/Solution
Check whether Inverter Maximum Current Limit is being reached.	<p>The drive will limit the maximum current to the inverter's peak current rating. Refer to Section 2.4 and 2.5 for ratings.</p> <p>If the peak current limit is being reached, this may be due to:</p> <ul style="list-style-type: none">Incorrect Motor Data. Refer to Motor Data Incorrect for additional information.Encoder Position Incorrect. Refer to Encoder/Motor Pole Position IncorrectMechanical Issues (eg. Brake not releasing) <p>For open loop induction motors, the LC32 Low Speed Torque Boost may be too high or too low.</p>

7.5 Learn Procedure Troubleshooting

Problem:	Troubleshoot:
Unable to start learn procedure.	<p>Check input signals:</p> <p>The Motor Tune, SPI, and the Encoder Pole Position Learn only require the Drive Enable (I7) to begin (for serial speed control modes, this includes the enable of the Control Word).</p> <p>The Encoder Synchronization and Inertia Learn require a run command (Drive Enable, Direction, and speed command).</p>
Unable to complete learn procedure successfully	<p>If 'Measurement Stopped by Controller' or 'Measurement Interrupted' is displayed, this indicates the Drive Enable (I7) input was dropped during the procedure.</p> <p>User dropped the run command.</p> <p>Controller dropped the run command.</p> <p>Controller timeout due to run command and no movement</p> <p>Controller speed following error if controller inspection speed not set to zero.</p> <p>Check Event Log to see if a drive fault occurred and troubleshoot the fault as necessary.</p>

Problem:	Troubleshoot:
<p>Unable to complete SPI procedure successfully</p>	<p>Ensure correct motor data and that a Motor Tune has been completed.</p> <p>During the procedure, if a 'Values are not consistent' is displayed, then a learned value falls out of range of the average of previous values and the process will not complete successfully, but can be done again as necessary.</p> <p>If the LE03 Swap Encoder Channels setting for whether A/B Channels Swapped is incorrect, this may cause more variance in the encoder/pole position samples.</p> <p>High motor inductance (> 100mH) values may have more variance in the encoder/pole position samples.</p> <p>The drive should automatically determine the correct LE07 Rotor Position Mode based on the learned motor data. It may be possible to try the other setting.</p>
<p>Unable to complete Encoder Synchronization procedure successfully</p>	<p>The motor must be able to run normally during this procedure.</p> <p>Check for any mechanical issues preventing movement.</p> <p>Ensure current is not excessive; if so, troubleshoot as necessary.</p> <p>For PM motors, the LE03 Swap Encoder Channels setting for the A/B phasing must be correct, which cannot be determined from the SPI procedure. If the SPI procedure was used to learn the encoder/pole position, change LE03 as needed and relearn encoder/pole position with SPI again before doing the Encoder Synchronization procedure.</p> <p>For Induction motors, the motor must be able to run in open loop. Adjust the LC32 Low Speed Torque Boost as necessary.</p> <p>If unable to run the car in the up direction (eg. at top terminal, etc.) as described in the procedure, run the car instead in the down direction. When prompted whether the elevator traveled in the up direction, answer No if it did and Yes if it didn't.</p>

Problem:	Troubleshoot:
Unable to complete Encoder Pole Position Learn successfully	<p>Ensure brake picks and the sheave is free to move relatively easily; should be able to rotate by hand.</p> <p>If the displayed position does not appear to change and the sheave does not move back and forth by a few inches, then the sheave is unable to move freely and the procedure cannot be complete.</p> <p>Ensure correct motor U, V, W phasing.</p>

Parameter Reference

8. Parameter Reference

8.1 v3.21 Parameter List Reference

Para.	Name	Hex	v1.72	Motor/Gear Type				Setting Options	NUM	Range		Units		Default	Pass Level
				I	IX	P	PX			Min.	Max.	Imp.	Met.		
US02	System Units	0282	-	RO	RO	RO	RO	m/sec ft/min	0 1	-	-	ft/min m/sec	ft/min	OEM	
US03	Motor Type	0283	US10					Induction Geared Induction Gearless PM Synchronous Geared PM Synchronous Gearless	0 1 2 3	-	-	-	-	Induction Geared	OEM
US04	Control Type	0284	LF2					Digital Speed Selection Binary Speed Selection Absolute Analog Speed Bi-Polar Analog Speed Serial Speed DIN66019, Serv.49 Serial Speed DIN66019, Serv.50 Serial Binary Speed DIN66019, Serv.50	0 1 2 3 4 5 6	-	-	-	-	Binary Speed Selection	OEM
US05	Load Configuration	0285	US4					Not Configured Configuration OK Write Config. to Drive Read Config. from Drive Write Config. to Flash Read Config. from Flash Write Config. to SD Card Read Config. from SD Card Create OEM Defaults Restore OEM Defaults Restore KEB Defaults	0 1 2 3 4 5 6 7 8 9 10	-	-	-	-	Not Configured	OEM
US06	Contract Speed	0286	LF20					m/s ft/min	0 1	0 0	1600 8.00	ft/min -	- m/s	ft/min	OEM
LI01	Type of Input	0381	di0					PNP NPN	0 1	-	-	-	-	PNP	OEM
LI02	Digital Input Filter	0382	-					-	-	10	100	msec	20	OEM	
LI03	Speed Input Decoding	0383	-					US04 Control Type = Binary Speed Selection B(Level - Correct - Inspection) + D(Level - Correct. - High - Inspect.) B(Inspection - Level - Correction) + D(Level - Correct. - High - Inspect.) B(Level - Correct - High) + D(Level - Correct. - High - Inspect.) Decode with LI16 + D(Level - Correct. - High - Inspect.)	0 1 2 3	-	-	-	-	(0); B(Level - Correct - Inspection) + D(Level - Correct - High - Inspect.)	OEM
								US04 Control Type = Digital Speed Selection B(Level - Correct - Inspection) + D(Level - Correct. - High - Inspect.) B(Level - Correct - Inspection) + D(Level - High - Inspect. - Interm.) B(Level - Correct - Inspection) + D(Inspection - Level - High - Interm.)	0 4 8						

Para.	Name	Hex	v1.72	Motor/Gear Type				Setting Options	NUM	Range		Units		Default	Pass Level
				I	IX	P	PX			Min.	Max.	Imp.	Met.		
LI04	Input 1 Function (I1)	0384	-					No Function*	0	-	-			No Function	OEM
								UPS Operation*	1						
								Reduced Torque*	2						
								Emergency Profile*	4						
								Emergency Generator Speed*	8						
								Fault Reset	16						
								External Fault	17						
								Brake Release Confirm.	18						
								Main Contactor Check	19						
								Earthquake Speed	20						
								Emergency Slowdown (ESD)	21						
								Position Selection	22						
								Position Deviation Reset	23						
								Teach Value	24						
Up Direction	25														
Down Direction	26														
Speed Selection	27														
ETS (Emergency Terminal Slowdown)	28														
NTS1 (Normal Terminal Slowdown)	29														
NTS2	30														
NTS3	31														
Inspection Speed	32														
*Can be selected together															
LI05	Input 2 Function (I2)	0385	-					Same as LI04	"	-	-	-	-	No Function	OEM
LI06	Input 3 Function (I3)	0386	-					Same as LI04	"	-	-	-	-	No Function	OEM
LI07	Input 4 Function (I4)	0387	-					Same as LI04	"	-	-	-	-	No Function	OEM
LI08	Input 5 Function (I5)	0388	-					Same as LI04	"	-	-	-	-	No Function	OEM
LI09	Input 6 Function (I6)	0389	-					Same as LI04	"	-	-	-	-	No Function	OEM
LI11	Input 8 Function (I8)	038B	-					Same as LI04	"	-	-	-	-	No Function	OEM
LI15	Direction Selection Inputs	038F	-					Direction Selection	0	-	-			(0); Up and Down Inputs + Function by Direction Inputs	OEM
								Up and Down Inputs	1						
								Down Input Only	2						
								Brake Function	0						
								Function by Direction Inputs	4						
LI16	Custom Input Decoding	0390	-					-	-	00000000h				00000000h	OEM
LI20	Brake Switch Function	0394	-					General Reset	0	-	-			General Reset	OEM
								3 Auto Resets	1						
								Forced Reset	2						
LM01	Motor Power	0681	LF10					-	-	0.5	299.5	HP	-	10	Basic
										0.3	225	-	kW	7.5	
										0.5	299.5	HP	-	Calculated	
										0.3	225	-	kW	Calculated	
LM02	Motor Speed	0682	LF11					-	-	20	4000	rpm	-	1164	Basic
										400	4000	-	rpm	1450	
										20.0	500.0	rpm		100.0	
										400	4000	rpm		1000	
										20.0	500.0	rpm		100.0	
LM03	Motor Current	0683	LF12					-	-	1.0	1000.0	Amps		1.0	Basic
LM04	Motor Frequency	0684	LF13					-	-	4.0	200.0	Hz	-	60.0	Basic
										4.0	200.0	-	Hz	50.0	
										4.0	200.0	Hz		50.0	
LM05	Motor Voltage	0685	LF14					-	-	10	32000	V		400	Basic
										10	500	V		100	
LM06	Motor Power Factor	0686	LF15					-	-	0.5	1.00	-		0.90	Basic
										NA	NA	NA	NA	NA	

I = Induction Geared, IX = Induction Gearless, P = PM Geared, PX = PM Gearless

Parameter Reference

Para.	Name	Hex	v1.72	Motor/Gear Type				Setting Options	NUM	Range		Units		Default	Pass Level
				I	IX	P	PX			Min.	Max.	Imp.	Met.		
LM07	Motor Torque	0687	LF17	RO				-	-	0.0	479.7	lb-ft	-	Calculated	Basic
					RO					0.0	655.0	-	Nm	Calculated	
										0.1	4797.0	lb-ft	-	Calculated	
										0	6550	-	Nm	Calculated	
										0.0	479.7	lb-ft	-	0.0	
										0.0	655.0	-	Nm	0.0	
										0	4797	lb-ft	-	0	
										1	65000	-	Nm	0	
LM08	Electric Motor Protection	0688	LF8					Off On	0 1	-	-	-	-	On	Adjuster
LM09	Electric Motor Protection Current	0689	LF9					-	-	1.0	1000.0	Amps		1.0	Basic
LM10	Motor Overheat Temp.	068A	-					-	-	NA	NA	NA	NA	NA	-
LM11	Peak Motor Current Factor	-	-					-	-	50	240	deg. Celsius		140	Adjuster
LM20	Motor Ls	0694	Ld21					-	-	0.01	655.35	mH		10.00	Adjuster
LM21			Motor Rs	0995	LF18				-	-	0.000			65.535	
LM22	Motor Rr	0696	Ld22					-	-	0.000	65.535	Ohm		1.000	Adjuster
LM23	Motor Lm	0697	Ld23					-	-	0.1	3276.7	mH		100.0	Adjuster
LM24	Field Weakening Corner	0698	LF16					-	-	1	4000	rpm		Calculated	Adjuster
LM25	Field Weakening Speed	0699	Ld18					-	-	NA	NA	NA	NA	NA	-
LM26	Motor Ls Max.	069A	Ld23					-	-	0.01	500.00	mH		0.01	Adjuster
LM27	Motor Inductance Mode	069B	Ld26					Ld <> Lq Ld = Lq	0 1	-	-	NA	NA	Ld <> Lq	Adjuster
LM30	Motor Control	069E	LM30					Off Motor Model Vmax Regulation Flux Control Flux Proofing Zero Speed Model *Can be selected together	0 1 2 4 8 16	-	-	-	-	Vmax Regulation	Adjuster
								Off Motor Model Vmax Regulation *Can be selected together	0 1 2	-	-	-	-	Vmax Regulation	
LM31	Vmax Regulation	069F	Ld25					-	-	0	110	%		97	Adjuster
LM32	KP Current	06A0	Ld27					-	-	1	32767	-	-	Calculated	Adjuster
LM33	KI Current	06A1	Ld28					-	-	1	32767	-	-	Calculated	Adjuster
LE01	Encoder 1 Interface (X3A)	0581	0LF26	RO	RO	RO	RO	-	-	-	-	-	-	R/O	Basic
LE02	Encoder 1 Pulse Number	0582	LF27					-	-	256	16384	ppr		1024	Basic
LE03	Swap Encoder 1 Channels	0583	LF28					Not Inverted A-B Swapped Inverted Rotation A-B Swapped & Inv. Rotation	0 1 2 3	-	-	-	-	Not Inverted	Basic

Para.	Name	Hex	v1.72	Motor/Gear Type				Setting Options	NUM	Range		Units		Default	Pass Level
				I	IX	P	PX			Min.	Max.	Imp.	Met.		
LE04	Sample Rate for Encoder 1	0584	LF29					0.5 ms (2kHz) 1 ms (1kHz) 2 ms (500Hz) 4 ms (250Hz) 8 ms (125Hz) 16 ms (63Hz) 32 ms (31Hz)	0 1 2 3 4 5 6	-	-	ms (Hz)		4 (250)	Basic
LE05	Encoder 1 Multiplier	0585	LF76					-	-	0	13	-	-	2 8	Adjuster
LE06	Encoder 1 Pole Position	0586	LF77					-	-	NA	NA	NA	NA	NA	Basic
LE07	Rotor Detection Mode	0587	-					-	-	0	65535	-	-	1000	Basic
LE08	Encoder Scaling	0588	-					Off Every Run	-	NA	NA	NA	NA	NA	Adjuster
LE09	Enc1 Numerator	0589	-					Off Reserved LE02 x LE09 / LE10	0 1 2	-	-	-	-	Off	OEM
LE10	Enc1 Denominator	058A	-					-	-	1	1073741823	-	-	1	OEM
LE11	Serial Encoder 1 Type	058B	-					-	-	-1073741824	1073741824	-	-	1	OEM
LE12	Serial Encoder 1 Status	058C	-					-	-	NA	NA	NA	NA	NA	Basic
LE13	UVW Enc. Commutation	058D	-					-	-	NA	NA	NA	NA	NA	Basic
LE14	Serial Enc1 Selection	058E	-					(0) = Motor Pairs of Poles	-	0	127	-	-	0	OEM
LE15	PT1 Time Encoder 1	058F	-					-	-	NA	NA	NA	NA	NA	OEM
LE16	SSI Data Format	0590	-					EnDat 2.2 BISS Hengstler Acuro BISS C-Mode	0 1 2	-	-	-	-	EnDat 2.2	OEM
LE17	SSI Data Resolution	0591	-					-	-	0	255	ms		0	Adjuster
LE31	Encoder 2 Interface (X3B)	059F	-					Binary Gray Scale	0 1	-	-	-	-	Binary	OEM
LE32	Encoder 2 Pulse Number	05A0	-					-	-	0	13	-	-	10	OEM
LE33	Encoder 2 Rotation	05A1	-					-	-	-	-	-	-	R/O	Basic
LE34	Sample Rate for Encoder 2	05A2	-					Not Inverted A-B Swapped Inverted Rotation A-B Swapped & Inv. Rotation	0 1 2 3	-	-	-	-	Not Inverted	Basic
LE35	Encoder 2 Output PPR	05A3	US83					0.5 ms (2kHz) 1 ms (1kHz) 2 ms (500Hz) 4 ms (250Hz) 8 ms (125Hz) 16 ms (63Hz) 32 ms (31Hz)	0 1 2 3 4 5 6	-	-	ms (Hz)		4 (250)	OEM
LE36	PT1 Time Encoder 2	05A4	-					Source Channel 1 Channel 2 Actual Value Reserved Actual Value	0 1 2 3	-	-	-	-	Channel 1 Direct	OEM
LE36	PT1 Time Encoder 2	05A4	-					256 512 1024 2048 Division Direct	0 4 8 12 0 2 4 8 16 32 64 128	-	-	-	-	Channel 1 Direct	OEM
LE36	PT1 Time Encoder 2	05A4	-					-	-	0	255	ms		0	Adjuster

Parameter Reference

Para.	Name	Hex	v1.72	Motor/Gear Type				Setting Options	NUM	Range		Units		Default	Pass Level
				I	IX	P	PX			Min.	Max.	Imp.	Met.		
LN01	Traction Sheave Diameter	0781	LF21						-	3.94	62.99	in	-	24.00	Basic
									-	100	1600	-	mm	610	
LN02	Gear Reduction Ratio	0782	LF22						-	1.00	250.00	x:1	30.00	Basic	
LN03	Roping Ratio	0783	LF23						-	1	4	x:1	1	Basic	
LN04	Load	0784	LF24						-	0	30000	lb	-	0	Basic
									-	0	13607	-	kg	0	
LN05	Estimated Gear Ratio	0785	LF25	RO	RO	RO	RO		-	0.00	250.00	x:1	Calculated	Basic	
LS01	Leveling Speed	0881	LF41						-	0	25	ft/min	-	4	Basic
									-	0.00	0.13	-	m/s	0.02	
LS02	High Speed	0882	LF42						-	0	1600	ft/min	-	0	Basic
									-	0.00	8.00	-	m/s	0.00	
LS03	Inspection Speed	0883	LF43						-	0	150	ft/min	-	30	Basic
									-	0.00	0.63	-	m/s	0.15	
LS04	Correction Speed	0884	LF44						-	0	50	ft/min	-	0	Basic
									-	0.00	0.25	-	m/s	0.00	
LS05	Intermediate Speed 1	0885	LF45						-	0	1600	ft/min	-	0	Basic
									-	0.00	8.00	-	m/s	0.00	
LS06	Intermediate Speed 2	0886	LF46						-	0	1600	ft/min	-	0	Basic
									-	0.00	8.00	-	m/s	0.00	
LS07	Intermediate Speed 3	0887	LF47						-	0	1600	ft/min	-	0	Basic
									-	0.00	8.00	-	m/s	0.00	
LS08	Earthquake Speed	0888	-						-	0	150	ft/min	-	0	Basic
									-	0.00	0.76	-	m/s	0.00	
LS09	Emergency Power Speed	0889	-						-	0	1600	ft/min	-	0	Basic
									-	0.00	8.00	-	m/s	0.00	
LS10	Battery Operation Speed	088A	-						-	0	50	ft/min	-	0	Basic
									-	0.00	0.25	-	m/s	0.00	
LS15	High Speed Profile	088F	-						Profile Setting	0				(0); Custom + External Profile	Basic
									Custom	1					
Medium	2														
Soft	3														
LS16	One Floor Profile	0890	-						Profile Source	0				Custom	Basic
									External Profile	1					
Internal Profile	2														
Custom	3														
LS17	Emergency Profile	0891	-						Same as LS16	""	-	-	-	Custom	Basic
LS20	Acceleration High Speed	0894	0LF51						-	0.30	12.00	ft/sec ²	-	2.30	Basic
									-	0.091	3.662	-	m/s ²	0.701	
LS21	Start Jerk High Speed	0895	0LF50						-	0.30	32.00	ft/sec ³	-	2.30	Basic
									-	0.091	9.759	-	m/s ³	0.701	
LS22	Accel. Jerk High Speed	0896	0LF52						-	0.30	32.00	ft/sec ³	-	2.30	Basic
									-	0.091	9.759	-	m/s ³	0.701	
LS23	Deceleration High Speed	0897	0LF54						-	0.30	12.00	ft/sec ²	-	2.30	Basic
									-	0.091	3.662	-	m/s ²	0.701	
LS24	Decel. Jerk High Speed	0898	0LF53						-	0.30	32.00	ft/sec ³	-	2.30	Basic
									-	0.091	9.759	-	m/s ³	0.701	
LS25	Stop Jerk High Speed	0899	0LF55						-	0.30	32.00	ft/sec ³	-	2.30	Basic
									-	0.091	9.759	-	m/s ³	0.701	

Para.	Name	Hex	v1.72	Motor/Gear Type				Setting Options	NUM	Range		Units		Default	Pass Level	
				I	IX	P	PX			Min.	Max.	Imp.	Met.			
LS27	High Speed Correction	089B	-						-	0.0	6.0	in	-	0.0	Basic	
									-	0.0	15.2	-	cm	0.0		
LS30	Acceleration One Floor	089E	1LF51						-	0.30	12.00	ft/sec ²	-	3.00	Adjuster	
									-	0.091	3.662	-	m/s ²	0.915		
LS31	Start Jerk One Floor	089F	1LF50						-	0.30	32.00	ft/sec ³	-	3.00	Adjuster	
									-	0.091	9.759	-	m/s ³	0.915		
LS32	Accel. Jerk One Floor	08A0	1LF52						-	0.30	32.00	ft/sec ³	-	3.00	Adjuster	
									-	0.091	9.759	-	m/s ³	0.915		
LS33	Deceleration One Floor	08A1	1LF54						-	0.30	12.00	ft/sec ²	-	3.00	Adjuster	
									-	0.091	3.662	-	m/s ²	0.915		
LS34	Decel. Jerk One Floor	08A2	1LF53						-	0.30	32.00	ft/sec ³	-	3.00	Adjuster	
									-	0.091	9.759	-	m/s ³	0.915		
LS35	Stop Jerk One Floor	08A3	1LF55						-	0.30	32.00	ft/sec ³	-	3.00	Adjuster	
									-	0.091	9.759	-	m/s ³	0.915		
LS37	Intermediate Speed 1 Correction	08A5	-						-	0.0	6.0	in	-	0.0	Adjuster	
									-	0.0	15.2	-	cm	0.0		
LS38	Intermediate Speed 2 Correction	08A6	-						-	0.0	6.0	in	-	0.0	Adjuster	
									-	0.0	15.2	-	cm	0.0		
LS40	Acceleration Emergency	08A8	2LF51						-	0.30	12.00	ft/sec ²	-	1.50	Adjuster	
									-	0.091	3.662	-	m/s ²	0.460		
LS41	Start Jerk Emergency	08A9	2LF50						-	0.30	32.00	ft/sec ³	-	1.50	Adjuster	
									-	0.091	9.759	-	m/s ³	0.460		
LS42	Accel. Jerk Emergency	08AA	2LF52						-	0.30	32.00	ft/sec ³	-	1.50	Adjuster	
									-	0.091	9.759	-	m/s ³	0.460		
LS43	Deceleration Emergency	08AB	2LF54						-	0.30	12.00	ft/sec ²	-	1.50	Adjuster	
									-	0.091	3.662	-	m/s ²	0.460		
LS44	Decel. Jerk Emergency	08AC	2LF53						-	0.30	32.00	ft/sec ³	-	1.50	Adjuster	
									-	0.091	9.759	-	m/s ³	0.460		
LS45	Stop Jerk Emergency	08AD	2LF55						-	0.30	32.00	ft/sec ³	-	1.50	Adjuster	
									-	0.091	9.759	-	m/s ³	0.460		
LS47	Intermediate Speed 3 Correction	08AF	-						-	0.0	6.0	in	-	0.0	Adjuster	
									-	0.0	15.2	-	cm	0.0		
LS48	ESD/ETS Deceleration	08B0	-						-	0.30	12.00	ft/sec ²	-	4.00	Adjuster	
									-	0.091	3.659	-	m/s ²	1.220		
LS49	ESD/ETS Jerk	08B1	-						-	0.30	32.00	ft/sec ³	-	4.00	Adjuster	
									-	0.091	9.756	-	m/s ³	1.220		
LS50	Acceleration Inspection	08B2	-						-	0.30	12.00	ft/sec ²	-	2.00	Adjuster	
									-	0.091	3.662	-	m/s ²	0.613		
LS51	Start Jerk Inspection	08B3	-						-	0.30	32.00	ft/sec ³	-	2.00	Adjuster	
									-	0.091	9.759	-	m/s ³	0.613		
LS52	Accel. Jerk Inspection	08B4	-						-	0.30	32.00	ft/sec ³	-	2.00	Adjuster	
									-	0.091	9.759	-	m/s ³	0.613		
LS53	Deceleration Inspection	08B5	-						-	0.30	12.00	ft/sec ²	-	2.00	Adjuster	
									-	0.091	3.662	-	m/s ²	0.613		
LS54	Decel. Jerk Inspection	08B6	-						-	0.30	32.00	ft/sec ³	-	2.00	Adjuster	
									-	0.091	9.759	-	m/s ³	0.613		
LS55	Stop Jerk Inspection	08B7	-						-	0.30	32.00	ft/sec ³	-	2.00	Adjuster	
									-	0.091	9.759	-	m/s ³	0.613		
LL01	Motor Tuning	0981	LF3						Off Start	0 1	-	-	-	-	Off	Basic

Parameter Reference

Para.	Name	Hex	v1.72	Motor/Gear Type				Setting Options	NUM	Range		Units		Default	Pass Level
				I	IX	P	PX			Min.	Max.	Imp.	Met.		
LL02	Tuning Current	0982	-					-	NA	NA	NA	NA	NA	-	
									10	100		%	100	Basic	
LL05	SPI	0985	LF3					-	NA	NA	NA	NA	NA	-	
								0	-	-	-	-	Off	Basic	
								1	-	-	-	-	Off	Basic	
LL06	Encoder Pole Position Learn	0986	LF3					-	NA	NA	NA	NA	NA	-	
								0	-	-	-	-	Off	Basic	
								1	-	-	-	-	Off	Basic	
LL07	Encoder Synchronization	0987	LF3					-	NA	NA	NA	NA	NA	-	
								0	-	-	-	-	Off	Basic	
								1	-	-	-	-	Off	Basic	
LL10	Inertia Learn	098A	LF3					-	NA	NA	NA	NA	NA	-	
								0	-	-	-	-	Off	Basic	
								1	-	-	-	-	Off	Basic	
LL15	Overspeed Test	098F	LF3					-	NA	NA	NA	NA	NA	-	
								0	-	-	-	-	Off	Basic	
								1	-	-	-	-	Off	Basic	
LL16	Overspeed Test Speed	0990	-					-	0	2400	ft/min	-	0	Basic	
								-	0.000	12.190	m/s	-	0.000	Basic	
LL17	Safety Release	0991	-					-	NA	NA	NA	NA	NA	-	
								0	-	-	-	-	Off	Basic	
								1	-	-	-	-	Off	Basic	
LL18	NTSD Tune Mode	0992	-					-	NA	NA	NA	NA	NA	-	
								0	-	-	-	-	Off	OEM	
								1	-	-	-	-	Off	OEM	
LC01	Control Mode	0B81	LF30					0	-	-	-	-	Closed Loop FOC	Basic	
								1	-	-	-	-	Closed Loop FOC	Basic	
								2	-	-	-	-	Closed Loop FOC	Basic	
								3	-	-	-	-	Closed Loop FOC	Basic	
								4	-	-	-	-	Closed Loop FOC	Basic	
								5	-	-	-	-	Closed Loop FOC	Basic	
LC02	Speed Gain Optimization	0B82	-					-	0	25	-	-	0	Basic	
LC03	KP Speed Acceleration	0B83	ALF31					-	1	50000	-	-	3000	Adjuster	
LC04	KP Speed Deceleration	0B84	dLF31					-	1	50000	-	-	3000	Adjuster	
LC05	KP Speed Pretorque	0B85	PLF31					-	1	50000	-	-	3000	Adjuster	
LC08	KI Speed Acceleration	0B88	ALF32					-	1	25000	-	-	250	Adjuster	
LC09	KI Speed Deceleration	0B89	dLF32					-	1	25000	-	-	250	Adjuster	
LC10	KI Speed Pretorque	0B8A	PLF32					-	1	30000	-	-	3000	Adjuster	
LC11	KI Speed Offset Accel	0B8B	ALF33					-	0	20000	-	-	3000	Basic	
LC12	KI Speed Offset Decel	0B8C	dLF33					-	0	20000	-	-	1000	Basic	
LC13	Speed for max KI Accel	0B8D	US20					-	1	50	ft/min	-	4	Adjuster	
								-	0.00	0.25	-	m/s	0.02	Adjuster	
LC14	Speed for min KI Decel	0B8E	US21					-	1	200	ft/min	-	16	Adjuster	
								-	0.00	1.00	-	m/s	0.08	Adjuster	
LC15	Speed for max KI Accel	0B8F	US20					-	1	50	ft/min	-	8	Adjuster	
								-	0.00	0.25	-	m/s	0.04	Adjuster	
LC16	Speed for min KI Decel	0B90	US21					-	1	200	ft/min	-	24	Adjuster	
								-	0.000	1.001	-	m/s	0.122	Adjuster	
LC20	Gain Profile Mode	0B94	-					0	-	-	-	-	Variable	Adjuster	
								1	-	-	-	-	Variable	Adjuster	
LC21	KP Speed Resonance Accel	0B95	-					-	0	400		%	50	Adjuster	
LC22	Speed at Resonance Accel	0B96	-					-	1	50	ft/min	-	4	Adjuster	
								-	0.00	0.25	-	m/s	0.02	Adjuster	
LC23	KP Speed Resonance Decel	0B97	-					-	0	400		%	50	Adjuster	
LC24	Speed at Resonance Decel	0B98	-					-	1	50	ft/min	-	4	Adjuster	
								-	0.00	0.25	-	m/s	0.02	Adjuster	
LC25	KP Speed High	0B99	-					-	0	400	-	-	100	Adjuster	
LC30	Maximum Torque	0B9E	0LF36					-	0	500		%	150	Basic	
LC31	Reduced Maximum Torque	0B9F	1LF36					-	0	500		%	100	Adjuster	

Para.	Name	Hex	v1.72	Motor/Gear Type				Setting Options	NUM	Range		Units		Default	Pass Level	
				I	IX	P	PX			Min.	Max.	Imp.	Met.			
LC32	Low Speed Torque Boost	0BA0	LF37					-	-	0	25.5	%	5.0	Basic		
										NA	NA	NA	NA			
LC33	Auto Boost Gain	0BA1	-					-	-	0	2.50	-	-	0.00	Adjuster	
										NA	NA	NA	NA	NA		
LC34	Digital Pretorque	0BA2	-					-	-	-100.0	100.0	%	0.0	Basic		
LC40	Accel. Torque	0BA8	Ld29					-	-	0	12036	lb-ft	-	0	Adjuster	
										0	30000	-	Nm	0		
LC41	System Inertia	0BA9	Ld30					-	-	0	65501	lb-in ²	-	0	Adjuster	
										0	65501	-	kgcm ²	0		
										0.0	1073.7	lb-yd ²	-	0.0		
										0.0	1073.7	-	kgm ²	0.0		
LC42	FFTC Filter	0BAA	Ld31					Off 250 Hz 125 Hz 63 Hz 31 Hz 16 Hz 8.0 Hz 4.0 Hz 2.0 Hz 1.0 Hz	0 1 2 3 4 5 6 7 8 9	-	-	Hz	Off	Adjuster		
LC43	FFTC Gain	0BAB	Ld32					-	-	0	200	%	0	Adjuster		
LC44	Torque Command Filter	0BAC	Ld33					Off 2000 Hz 1000 Hz 500 Hz 250 Hz 125 Hz 63 Hz 31 Hz	0 1 2 3 4 5 6 7	-	-	Hz	2000	Adjuster		
LT01	Brake Release Delay	0E81	LF71					-	-	0.00	1.00	sec	0.05	Basic		
LT02	Control Hold Off	0E82	-					-	-	0.00	1.00	sec	0.40	Basic		
LT03	Speed Start Delay	0E83	LF70					-	-	0.00	3.00	sec	0.70	Basic		
LT10	Brake Drop Delay	0E8A	-					-	-	0.00	1.00	sec	0.10	Basic		
LT12	Current Hold Time	0E8C	LF78					-	-	0.00	2.00	sec	0.50	Adjuster		
LT13	Current Ramp Down Time	0E8D	LF79					-	-	0.10	0.50	sec	0.30	Adjuster		
LP01	Positioning Control	0C81	LP1					Off Posi One Floor Learn Slowdown Position Value Reset	0 1 2 3	-	-	-	-	Off	Basic	
LP02	Minimum Slowdown Distance	0C82	LP2	RO	RO	RO	RO	-	-	0.00	600.00	in	-	0.00	Basic	
										0.0		-	0.0			
LP03	High Speed Slowdown Dist.	0C83	LP3					-	-	0.00	600.00	in	-	0.00	Basic	
										0.0		-	0.0			
LP04	Short Floor Slowdown Distance	0C84	-					-	-	0.00	600.00	in	-	0.00	Basic	
										0.0		-	0.0			
LP05	Correction Distance	0C85	LP4					-	-	0.00	25.00	in	-	0.00	OEM	
										0.0		-	0.0			
LP06	Scaling Increments High	0C86	LP21					-	-	0	9999	-	-	0	-	
LP07	Scaling Increments Low	0C87	LP22					-	-	0	9999	-	-	0	-	
LP08	Scaling Distance	0C88	LP23					-	-	0.00	600.00	in	-	0.00	-	
										0.0	15240.0	-	mm	0.0		
LP10	Floor Number	0C8A	-					Not yet implemented	-	1	30	-	-	1	-	
LP11	Floor Enable	0C8B	-					Not yet implemented Disabled Enabled	0 1	-	-	-	-	Disabled	-	

Parameter Reference

Para.	Name	Hex	v1.72	Motor/Gear Type				Setting Options	NUM	Range		Units		Default	Pass Level
				I	IX	P	PX			Min.	Max.	Imp.	Met.		
LP12	Floor Position	0C8C	-							0.0	6553.5	in	-	0.0	-
LP13	Correction Distance Up	0C8D	-							0.0	25.0	in	-	0.0	-
LP14	Correction Distance Down	0C8E	-							0.0	25.0	in	-	0.0	-
LP15	Max Floor Speed	0C8F	-							0	1600	ft/min	-	0	-
										0.00	8.00	-	m/s	0.00	-
LP16	Floor Label	0C90	-							1	65535	-	-	1	-
LP18	Leveling Distance	0C92	-							0.0	12.0	in	-	0.0	-
LP19	Re-leveling Distance	0C93	-							0.0	3.0	in	-	0.0	-
LP20	Position Feedback Source	0C94	-						0 1 2	-	-	-	-	Motor Encoder	-
LP21	Reference Floor	0C95	-							0	30	-	-	1	-
LP22	Reference Direction	0C96	-						0 1 2	-	-	-	-	Up	-
LP23	Reference Speed	0C97	-							0	1600	ft/min	-	0	-
										0.00	8.00	-	m/s	0.00	-
LX01	Auto Reset	0D81	LF5							0	10	-	-	5	Basic
LX02	Switching Frequency	0D82	LF38						0 1 2	-	-	kHz		16	Basic
LX06	Function Test	0D86	US37						0 1	-	-	-	-	Off	Basic
LX08	Phase Current Check	0D88	US25						0 1	-	-	-	-	Phase Current Check	Adjuster
LX09	Watchdog Time	0D89	US29							Off (0)	10.00	sec		1.00	Adjuster
LX10	EdOH Function	0D8A	US33						0 1	-	-	-	-	Off	Adjuster
LX11	Reference Splitting	0D8B	US35							0	127	msec		0	OEM
LX12	Baud Rate	0D8C	US36						0 1 2 3 4 5 6 7	-	-	bps		38400	OEM
LX13	Speed Following Error	0D8D	LF57						0 1	-	-	-	-	On with Error	Adjuster
LX14	Speed Difference	0D8E	LF58							1	50	%		10	Adjuster
LX15	Speed for Pre-Opening	0D8F	-							1	100	ft/min	-	59	Adjuster
										0.005	0.508	-	m/s	0.300	
LX16	Decel Confirmation Speed	0D90	-							0	1600	ft/min	-	0	Adjuster
										0.000	8.128	-	m/s	0.000	
LX17	ETS Speed	0D91	-							0	1600	ft/min	-	0	Adjuster
										0.000	8.128	-	m/s	0.000	
LX18	Braking Resistance	0D92	-							0.0	200.0	Ohm		0.0	Adjuster
CH01	Default Parameters	0F81	-						0 1	-	-	-	-	Off	Basic

Para.	Name	Hex	v1.72	Motor/Gear Type				Setting Options	NUM	Range		Units		Default	Pass Level
				I	IX	P	PX			Min.	Max.	Imp.	Met.		
CH02	Save Parameters	0F82	-					Off Save to flash Save to card Write to drive	0 1 2 3	-	-	-	-	Off	Basic
CH03	Restore Parameters	0F83	-					Off Restore from flash Restore from card Restore from drive Load Motor Data	0 1 2 3 4	-	-	-	-	Off	Basic
CH05	Motor Type	0F85	-							0	76	-	-		Basic
CH06	Rope Ratio	0F86	-					1:1 2:1 4:1	0 1 2	-	-	-	-	1:1	Basic
CH07	Contract Speed	0F87	-					See parameter description		0	14	ft/min	m/sec		Basic
CH08	Car Capacity	0F88	-					See parameter description		0	11	lbs	kg		Basic
CH09	Program the selection	0F89	-					Off Program	0 1	0	1	-	-	Off	Basic
CH10	Left LED Function	0F8A	-					Default Normal Function Input Status (Dg01) Output Status (Dg11) Output Condition Status (Dg16) Lift App. Control Word Inverter Control Word (Sy.50) Field Bus Control Word CAN Bus Control Word Raw Memory Address	0 1 2 3 4 5 6 7 8	-	-	-	-	Default Normal Function	Adjuster
CH11	Left LED Address	0F8B	-					-	-	0h	7FFFFFFF	-	-	0000000h	Adjuster
CH12	Left LED Bit Number	0F8C	-					-	-	0h	7FFFFFFF	-	-	0000000h	Adjuster
CH13	Right LED Function	0F8D	-					Same as CH10	-	0h	7FFFFFFF	-	-	Default Normal Function	Adjuster
CH14	Right LED Address	0F8E	-					-	-	0h	7FFFFFFF	-	-	0000000h	Adjuster
CH15	Right LED Bit Number	0F8F	-					-	-	0h	7FFFFFFF	-	-	0000000h	Adjuster
LA01	AnIn1 Noise Filter	0A81	-					Off 2 ms 4 ms 8 ms 16 ms 32 ms 64 ms	0 1 2 3 4 5 6	-	-	ms		16	Adjuster
LA04	AnIn1 Dead Band	0A84	-					-	-	-10.0	+10.0	%		0.0	Adjuster
LA05	AnIn1 Gain	0A85	-					-	-	-200	+200	%		100	Adjuster
LA06	AnIn1 X Offset	0A86	-					-	-	-100.0	+100.0	%		0.0	Adjuster
LA07	AnIn1 Y Offset	0A87	-					-	-	-100.0	+100.0	%		0.0	Adjuster
LA14	AnIn2 Dead Band	0A8E	-					-	-	-10.0	+10.0	%		0.0	Adjuster
LA15	AnIn2 Gain	0A8F	-					-	-	-200	+200	%		100	Adjuster
LA16	AnIn2 X Offset	0A90	-					-	-	-100.0	+100.0	%		0.0	Adjuster
LA17	AnIn2 Y Offset	0A91	-					-	-	-100.0	+100.0	%		0.0	Adjuster
LA31	AnOut1 Function	0A9F	-					Absolute Actual Speed Absolute Command Speed Actual Speed Command Speed Output Voltage DC Bus Voltage Phase Current Actual Torque	0 1 2 3 4 5 6 7	-	-	-	-	Actual Speed	Adjuster
LA33	AnOut1 Gain	0AA1	-					-	-	-2000	+2000	%		100	Adjuster
LA34	AnOut1 X Offset	0AA2	-					-	-	-100.0	+100.0	%		0.0	Adjuster
LA35	AnOut1 Y Offset	0AA3	-					-	-	-100.0	+100.0	%		0.0	Adjuster
LA36	AnOut2 Function	0AA4	-					Same as LA31	-	-	-	-	-	Actual Torque	Adjuster
LA38	AnOut2 Gain	0AA6	-					-	-	-2000	+2000	%		100	Adjuster
LA39	AnOut2 X Offset	0AA7	-					-	-	-100.0	+100.0	%		0.0	Adjuster
LA40	AnOut2 Y Offset	0AA8	-					-	-	-100.0	+100.0	%		0.0	Adjuster

I = Induction Geared, IX = Induction Gearless, P = PM Geared, PX = PM Gearless

Parameter Reference

Para.	Name	Hex	v1.72	Motor/Gear Type				Setting Options	NUM	Range		Units		Default	Pass Level
				I	IX	P	PX			Min.	Max.	Imp.	Met.		
LO01	Output Inversion	1081	do42					None /O1 /O2 /O1 + /O2 /RLY1 /RLY1 + /O1 /RLY1 + /O2 /RLY1 + /O1 + /O2 /RLY2 /RLY2 + /O1 /RLY2 + /O2 /RLY2 + /O1 + /O2 /RLY2 + /RLY1 /RLY1 + /RLY2 + /O1 /RLY1 + /RLY2 + /O2 /RLY1 + /RLY2 + /O1 + /O2	0 1 2 3 4 5 6 7 8 9 10 11 12 13 14 15	-	-	-	-	None	OEM
LO05	Output Function O1	1085	-					Off Fault Drive Ready Drive On Brake Control At Speed High Speed Deceleration Active Speed for Door Pre-Opening Leveling Zone Main Contact Control Motor Overheat Cabinet Fan On Condition 1 NTSD Output	0 1 2 3 4 5 6 7 8 9 10 11 12 13 14	-	-	-	-	At Speed	OEM
LO10	Output Function O2	108A	-					Same as LO05	----	-	-	-	-	Deceleration Active	OEM
LO15	Output Function RLY1	108F	-					Same as LO05	----	-	-	-	-	Off	OEM
LO20	Output Function RLY2	1094	-					Same as LO05	----	-	-	-	-	Brake Control	OEM
LO30	Data Value 1	109E	-					-	-	1	62	-	-	1	OEM
LO31	Condition 1	109F	-					< <= = >= > < (AbsVal) = (AbsVal) > (AbsVal)	0 1 2 3 4 5 6 7	-	-	-	-	>	OEM
LO32	Comparison Level 1	10A0	-					-	-	-32000.0	32000.0	-	-	0.0	OEM
DG01	Input Status	1181h	ru21	RO	RO	RO	RO	None I7 I8 I15 I16 I11 I12 I13 I14	0 1 2 4 8 16 32 64 128	0	255	-	-	-	
DG02	Inverter Status	1182h	ru0 LF99	RO	RO	RO	RO	See Section 6.16	-	0	255	-	-	-	
DG03	Command Speed	1183h	ru2 LF88	RO		RO		-	-	-4000	4000	rpm		0	
					RO		RO			-500.0	500.0			0.0	
DG04	Elevator Position	1184h	ru54	RO	RO	RO	RO	-	-	-12000.00	12000.00	in.	-	0.00	
										-30480.00	30480.00	-	cm	0.00	
DG05	Actual Torque	1185h	ru12	RO		RO		-	-	-2214.0	2214.0	lb-ft	-	0.0	
										-3000.0	3000.0	-	Nm	0.0	
					RO		RO			-22140	22140	lb-ft	-	0	
										-30000	30000	-	Nm	0	
DG06	Motor Current	1186h	ru15 LF93	RO	RO	RO	RO	-	-	-3200.0	3200.0	Amps		0.0	
DG07	Motor Speed	1187h	ru9 LF89	RO		RO		-	-	-4000	4000	rpm		0	
					RO		RO			-500.0	500.0			0.0	
DG08	DC Bus Voltage	1188h	ru18 LF95	RO	RO	RO	RO	-	-	0	1000	Volts		0	

Para.	Name	Hex	v1.72	Motor/Gear Type				Setting Options	NUM	Range		Units		Default	Pass Level
				I	IX	P	PX			Min.	Max.	Imp.	Met.		
DG09	Magnetizing Current	1189h	ru87	RO	RO	RO	RO	-	-	-3200.0	3200.0	A		0.0	
DG10	Modulation Grade	118Ah	ru42	RO	RO	RO	RO	-	-	0	110	%		0	
DG11	Output Status	118Bh	ru25 LF83	RO	RO	RO	RO	None O1 O2 RLY1 RLY2	0 1 2 4 8	0	15	-	-	0	
DG16	Output Condition State	1190h	ru23	RO	RO	RO	RO	None Condition 0 Condition 1 Condition 2 Condition 3 Condition 4 Condition 5 Condition 6 Condition 7	0 1 2 4 8 16 32 64 128	0	255	-	-	0	
DG17	Output Frequency	1191h	ru3 LF97	RO	RO	RO	RO	-	-	-400.0	400.0	Hz		0.0	
DG18	Output Voltage	1192h	ru20	RO	RO	RO	RO	-	-	0	1000	Volts		0	
DG19	Parameter Set	1193h	ru26	RO	RO	RO	RO	-	-	0	7	-	-	0	
DG20	Raw Pattern	1194h	ru27	RO	RO	RO	RO	-	-	-10.00	10.00	VDC		0.00	
DG21	Processed Pattern	1195h	ru28	RO	RO	RO	RO	-	-	-10.00	10.00	VDC		0.00	
DG30	Peak DC Volts	119Eh	ru19 LF96	RO	RO	RO	RO	-	-	0	1500	Volts		0	
DG31	Peak Current	119Fh	ru16 LF94	RO	RO	RO	RO	-	-	-3200.0	3200.0	Amps		0.0	
DG32	Peak Speed	11A0h	ru85	RO	RO	RO	RO	-	-	0 0.000	2500 12.700	ft/min -	- m/s	0 0.000	
DG33	Raw Pretorque	11A1h	ru29	RO	RO	RO	RO	-	-	-10.00	10.00	VDC		0.00	
DG34	Post Pretorque	11A2h	ru30	RO	RO	RO	RO	-	-	-10.00	10.00	VDC		0.00	
DG35	Analog Output 1	11A3h	ru34	RO	RO	RO	RO	-	-	-10.00	10.00	VDC		0.00	
DG36	Analog Output 2	11A4h	ru36	RO	RO	RO	RO	-	-	-10.00	10.00	VDC		0.00	
DG37	Heatsink Temperature	11A5h	ru38	RO	RO	RO	RO	-	-	0	120	Degree Celsius		0	
DG38	Motor Temperature	11A6h	ru46	RO	RO	RO	RO	-	-	0: T1-T2 Closed	150	Degree Celsius		0	
DG39	Carrier Frequency	11A7h	ru45	RO	RO	RO	RO	2 kHz 4 kHz 8 kHz 12 kHz 16 kHz	0 1 2 3 4	2	16	kHz		0	
DG40	Electric Power	11A8h	ru92	RO	RO	RO	RO	-	-	-320.0	320.0	kW		0.0	
DG41	Motor Power	11A9h	ru81	RO	RO	RO	RO	-	-	-320.0	320.0	kW		0.0	
DG42	Braking Energy	11AAh	ru91	RO	RO	RO	RO	-	-	0	65535	kWh		0	
DG43	Power On Counter	11ABh	ru40	RO	RO	RO	RO	-	-	0	65535	hr		0	
DG44	Run Time Counter	11ACh	ru41	RO	RO	RO	RO	-	-	0	65535	hr		0	
DG45	Overload Counter	11ADh	ru39	RO	RO	RO	RO	-	-	0	100	%		0	
DG46	Drive Load	11AEh	ru13 LF87	RO	RO	RO	RO	-	-	0	500	%		0	
DG47	Peak Load	11AFh	ru14	RO	RO	RO	RO	-	-	0	500	%		0	
DG50	Elevator Speed	11B2h	LF90	RO	RO	RO	RO	-	-	0 0.000	2000 10.160	ft/min -	- m/s	0 0.000	
DG51	Mode	11B3h		RO	RO	RO	RO	See Section 6.16	-	0	65535	-	-	0	
DG52	Active Profile	11B4h		RO	RO	RO	RO	None Inspection High Speed One Floor Emergency Correction Emergency Slowdown	0 1 2 4 8 16 32	0	65535	-	-	0	

Parameter Reference

Para.	Name	Hex	v1.72	Motor/Gear Type				Setting Options	NUM	Range		Units		Default	Pass Level
				I	IX	P	PX			Min.	Max.	Imp.	Met.		
DG53	Active Speed	11B5h		RO	RO	RO	RO	None Inspection Speed Leveling Speed Correction Speed High Speed Intermediate Speed 1 Earthquake Speed Intermediate Speed 2 Emergency Gernator Speed Intermediate Speed 3 UPS Speed	0 32 64 96 128 160 256 384 512 640 768	0	65535	-	-	0	
DG54	Leveling Distance	11B6h		RO	RO	RO	RO	-	-	0.0	18.0	in	-	0.0	
DG55	Target Floor	11B7h		RO	RO	RO	RO	-	-	0	64	-	-	0	
DG56	Current Floor	11B8h		RO	RO	RO	RO	-	-	0	64	-	-	0	
DG57	Next Avail. Floor	11B9h		RO	RO	RO	RO	-	-	0	64	-	-	0	
DG58	Car Load	11BAh		RO	RO	RO	RO	-	-	-100	100	%		0	
DG59	Brake Release Time	11BBh		RO	RO	RO	RO	-	-	0.00	5.00	sec		0.00	
DG60	Average Regen Power	11BCh		RO	RO	RO	RO	-	-	0.0	3000.0	kW		0.0	
DG61	Peak Regen Power	11BDh		RO	RO	RO	RO	-	-	0.0	3000.0	kW		0.0	
DG62	Runs Per Hour	11BEh		RO	RO	RO	RO	-	-	0	500	-	-	0	
DG63	NTSD Speed 1 Up	11BFh		RO	RO	RO	RO	-	-	0	-	ft/min	m/s	0	
DG64	NTSD Speed 2 Up	11C0h						-	-			ft/min	m/s	-	
DG65	NTSD Speed 3 Up	11C4h						-	-			ft/min	m/s	-	
DG66	NTSD Speed 1 Down	11C5h						-	-			ft/min	m/s	-	
DG67	NTSD Speed 2 Down	11C6h						-	-			ft/min	m/s	-	
DG68	NTSD Speed 3 Down	11C7h						-	-			ft/min	m/s	-	
FB01	Field Bus Control Word	1281		RO	RO	RO	RO	-	-	0h	FFFFh	-	-	-	OEM
FB02	Field Bus Speed	1282		RO	RO	RO	RO	-	-	-32767	32767	-	-	-	OEM
FB03	Field Bus Pretorque	1283		RO	RO	RO	RO	-	-	-100	100	%		-	OEM
FB04	Field Bus Target Position	1284		RO	RO	RO	RO	-	-	-2147483647	2147483647	-	-	-	OEM
FB05	Fb Control Word Mask	1285						-	-	0h	FFFFh	-	-	FFFFh	OEM
FB06	Speed Scale Multiplier	1286						-	-	0	65535	-	-	1	OEM
FB07	Speed Scale Right Shift	1287						-	-	0	15	-	-	0	OEM
FB08	Position Scale Multiplier	1288						-	-	0	65535	-	-	1	OEM
FB09	Position Scale Right Shift	1289						-	-	0	15	-	-	0	OEM
FB10	DIN66019 Fb Node ID	128A						-	-	1	128	-	-	1	OEM
FB11	DIN66019 Fb Baud Rate	128B						9600 bps 19200 bps 38400 bps 55500 bps 115200 bps	0 1 2 3 4	-	-	-	-	38400	OEM
FB12	DIN66019 Fb Watchdog	128C						-	-	20	1000	ms		50	OEM
FB13	PDO1 Map Assignment	128D						-	-	11810101h	11C0FF04h	-	-		OEM
FB14	PDO2 Map Assignment	128E						-	-	11810101h	11C0FF04h	-	-		OEM
FB15	PDO3 Map Assignment	128F						-	-	11810101h	11C0FF04h	-	-		OEM
FB16	PDO4 Map Assignment	1290						-	-	11810101h	11C0FF04h	-	-		OEM
FB17	PDI1 Map Assignment	1291						-	-	12810102h	1284FF04h	-	-		OEM
FB18	PDI2 Map Assignment	1292						-	-	12810102h	1284FF04h	-	-		OEM
FB19	PDI3 Map Assignment	1293						-	-	12810102h	1284FF04h	-	-		OEM
FB20	PDI4 Map Assignment	1294						-	-	12810102h	1284FF04h	-	-		OEM

Para.	Name	Hex	v1.72	Motor/Gear Type				Setting Options	NUM	Range		Units		Default	Pass Level
				I	IX	P	PX			Min.	Max.	Imp.	Met.		
FB21	Fb Special Function 1	1295						No Function*	0	-	-	-	-	No Function	OEM
								UPS Operation*	1						
								Reduced Torque*	2						
								Emergency Profile*	4						
								Emergency Generator Speed*	8						
								Fault Reset	16						
								External Fault	17						
								Brake Release Confirm.	18						
								Main Contactor Check	19						
								Earthquake Speed	20						
								Emergency Slowdown (ESD)	21						
								Position Selection	22						
								Position Deviation Reset	23						
								Teach Value	24						
Up Direction	25														
Down Direction	26														
Speed Selection	27														
ETS (Emergency Terminal Slowdown)	28														
NTS1 (Normal Terminal Slowdown)	29														
NTS2	30														
NTS3	31														
Inspection Speed	32														
*Can be selected together															
FB22	Fb Special Function 2	1296						Same as FB21	""	-	-	-	-	No Function	OEM
FB23	Fb Special Function 3	1297						Same as FB21	""	-	-	-	-	No Function	OEM
FB24	Fb Special Function 4	1298						Same as FB21	""	-	-	-	-	No Function	OEM
FB25	Fb Special Function 5	1299						Same as FB21	""	-	-	-	-	No Function	OEM
FB26	Fb Special Function 6	129A						Same as FB21	""	-	-	-	-	No Function	OEM
FB27	Fb Special Function 7	129B						Same as FB21	""	-	-	-	-	No Function	OEM
FB30	PDO1 Data	129E		RO	RO	RO	RO	-	-	80000000h	7FFFFFFFh	-	-	-	OEM
FB31	PDO2 Data	129F		RO	RO	RO	RO	-	-	80000000h	7FFFFFFFh	-	-	-	OEM
FB32	PDO3 Data	12A0		RO	RO	RO	RO	-	-	80000000h	7FFFFFFFh	-	-	-	OEM
FB33	PDO4 Data	12A1		RO	RO	RO	RO	-	-	80000000h	7FFFFFFFh	-	-	-	OEM
FB34	PDI1 Data	12A2		RO	RO	RO	RO	-	-	80000000h	7FFFFFFFh	-	-	-	OEM
FB35	PDI2 Data	12A3		RO	RO	RO	RO	-	-	80000000h	7FFFFFFFh	-	-	-	OEM
FB36	PDI3 Data	12A4		RO	RO	RO	RO	-	-	80000000h	7FFFFFFFh	-	-	-	OEM
FB37	PDI4 Data	12A5		RO	RO	RO	RO	-	-	80000000h	7FFFFFFFh	-	-	-	OEM
FB50	Temp DIN Com Err. Cnt.	12B2						-	-	0	65535	-	-	0	OEM
FB51	Temp DIN Com Err. Serv.	12B3						-	-	0	128	-	-	0	OEM
FB52	Temp DIN Com Err. Ack.	12B4						-	-	-32768	32768	-	-	0	OEM
FB53	Temp DIN Com Err. Val.	12B5						-	-	-2147483647	2147483647	-	-	0	OEM
FB54	RS485 Mode	12B6						Full Duplex	0	0	1	-	-	Full Duplex	OEM
								Half Duplex	1						
FB55	Software Filter	12B7						-	-	0: Off	255	ms	-	0: Off	OEM
TS01	NTSD Mode	1381h						External	0	0	4	-	-	External	OEM
								Threshold 1	1						
								Threshold 2, Binary Encoded	2						
								Threshold 3, Binary Encoded	3						
TS02	NTSD Target Speed	1382h						-	-	0	1600	ft/min	-	0	OEM
								-	-	0.000	8.128	-	m/s	0.000	
TS03	NTSD Speed 1 Up	1383h						-	-	0	1600	ft/min	-	0	OEM
								-	-	0.000	8.128	-	m/s	0.000	
TS04	NTSD Speed 2 Up	1384h						-	-	0	1600	ft/min	-	0	OEM
								-	-	0.000	8.128	-	m/s	0.000	
TS05	NTSD Speed 3 Up	1385h						-	-	0	1600	ft/min	-	0	OEM
								-	-	0.000	8.128	-	m/s	0.000	
TS06	NTSD Speed 1 Down	1386h						-	-	0	1600	ft/min	-	0	OEM
								-	-	0.000	8.128	-	m/s	0.000	
TS07	NTSD Speed 2 Down	1387h						-	-	0	1600	ft/min	-	0	OEM
								-	-	0.000	8.128	-	m/s	0.000	

Parameter Reference

Para.	Name	Hex	v1.72	Motor/Gear Type				Setting Options	NUM	Range		Units		Default	Pass Level
				I	IX	P	PX			Min.	Max.	Imp.	Met.		
TS08	NTSD Speed 3 Down	1388h						-	0	1600	ft/min	-		OEM	
									0.000	8.128	-	m/s	0.000		

8.2 v1.72 Crossover Reference

v1.72 Parameter	Description	v3.21 Parameter	v3.21 Description
LF.2	Steering Mode	US04	Control Type
LF.3	Drive Configuration	LL01-10	Tuning Parameters
	Run	-	
	config	-	
	Stop (Econfig)	-	
	S Lrn	LL01	Motor Tuning
	I Lrn	LL10	Inertia Learn
	P Lrn	LL06	Encoder Pole Position Learn
	SPI	LL05	SPI
LF.4	Motor Mode	-	
LF.5	Auto Reset	LX01	Auto Reset
LF.8	Electronic Motor Protection	LM08	Electric Motor Protection
LF.9	Electronic Motor Protection (IM)	LM09	Electric Motor Protection Current
LF.9	Peak Current Limit (PM)	LM11	Peak Motor Current Factor
LF.10	Rated Motor Power	LM01	Motor Power
LF.11	Rated Motor Speed	LM02	Motor Speed
LF.12	Rated Motor Current	LM03	Motor Current
LF.13	Rated Motor Frequency	LM04	Motor Frequency
LF.14 (IM)	Rated Motor Voltage	LM05	Motor Voltage
LF.14 (PM)	VAC(rms) at Rated Speed	LM05	Motor Voltage
LF.15	Power Factor	LM06	Motor Power Factor
LF.16	Field Weakening Speed	LM22	Field Weakening Corner
LF.17	Rated Motor Torque	LM07	Motor Torque
LF.18	Motor Resistance	LM21	Motor Rs
LF.19	Motor Inductance	LM20	Motor Ls
LF.20	Contract Speed	US06	Contract Speed
LF.21	Traction Sheave Diameter	LN01	Traction Sheave Diameter
LF.22	Gear Reduction Ratio	LN02	Gear Reduction Ratio
LF.23	Roping Ratio	LN03	Roping Ratio
LF.24	Load	LN04	Load
LF.25	Estimated Gear Ratio	LN05	Estimated Gear Ratio
0.LF.26	Encoder Feedback Interface	LE01	Encoder 1 Interface
1.LF.26	Encoder Type	LE11	Serial Enc. 1 Type
2.LF.26	Encoder Status	LE12	Serial Enc. 1 Status
3.LF.26	Read/Write Encoder	-	
LF.27	Encoder Pulse Number	LE02	Encoder Pulse Number
LF.28	Swap Encoder Channels	LE03	Swap Encoder Channels
LF.29	Sample Rate for Encoder	LE04	Sample Rate for Encoder
LF.30	Control Mode	LC01	Control Mode
A.LF.31	KP Speed (Accel)	LC03	KP Speed Acceleration
d.LF.31	KP Speed (Decel)	LC04	KP Speed Deceleration

Crossover Reference

v1.72 Parameter	Description	v3.21 Parameter	v3.21 Description
P.LF.31	KP Speed (Pre-torque)	LC05	KP Speed Pretorque
A.LF.32	KI Speed (Accel)	LC08	KI Speed Acceleration
d.LF.32	KI Speed (Decel)	LC09	KI Speed Deceleration
P.LF.32	KI Speed (Pre-torque)	LC10	KI Speed Pretorque
A.LF.33	KI Speed Offset (Accel)	LC11	KI Speed Offset Acceleration
d.LF.33	KI Speed Offset (Decel)	LC11	KI Speed Offset Deceleration
0.LF.36	Maximum Torque	LC30	Maximum Torque
1.LF.36	Maximum Torque (Emergency)	LC31	Reduced Maximum Torque
LF.37	Low Speed Torque Boost	LC32	Low Speed Torque Boost
LF.38	Switching Frequency	LX02	Switching Frequency
LF.41	Leveling Speed	LS01	Low Speed
LF.42	High Speed	LS02	High Speed
LF.43	Inspection Speed	LS03	Inspection Speed
LF.44	High Leveling Speed	LS04	Correction Speed
LF.45	Intermediate Speed 1	LS05	Intermediate Speed 1
LF.46	Intermediate Speed 2	LS06	Intermediate Speed 2
LF.47	Intermediate Speed 3	LS07	Intermediate Speed 3
0.LF.50	Start Jerk (High, Int. 1-3 Speeds)	LS21 LS31	Start Jerk High Speed Start Jerk One Floor
1.LF.50	Start Jerk (Inspection, High Level)	LS51	Start Jerk Inspection
2.LF.50	Start Jerk (Emergency)	LS41	Start Jerk Emergency
0.LF.51	Acceleration (High, Int. 1-3 Speeds)	LS20 LS30	Acceleration High Speed Acceleration One Floor
1.LF.51	Acceleration (Inspection, High Level)	LS50	Acceleration Inspection
2.LF.51	Acceleration (Emergency)	LS40	Acceleration Emergency
0.LF.52	Acceleration Jerk (High, Int. 1-3 Speeds)	LS22 LS32	Accel. Jerk High Speed Accel. Jerk One Floor
1.LF.52	Acceleration Jerk (Inspection, High Level)	LS52	Accel. Jerk Inspection
2.LF.52	Acceleration Jerk (Emergency)	LS42	Accel. Jerk Emergency
0.LF.53	Deceleration Jerk (High, Int. 1-3 Speeds)	LS24 LS34	Decel. Jerk High Speed Decel. Jerk One Floor
1.LF.53	Deceleration Jerk (Inspection, High Level)	LS54	Decel. Jerk Inspection
2.LF.53	Deceleration Jerk (Emergency)	LS44	Decel. Jerk Emergency
0.LF.54	Deceleration (High, Int. 1-3 Speeds)	LS23 LS33	Deceleration High Speed Deceleration One Floor
1.LF.54	Deceleration (Inspection, High Level)	LS53	Deceleration Inspection

v1.72 Parameter	Description	v3.21 Parameter	v3.21 Description
2.LF.54	Deceleration (Emergency)	LS43	Deceleration Emergency
0.LF.55	Flare Jerk (High, Int.1-3 Speeds)	LS25 LS35	Stop Jerk High Speed Stop Jerk One Floor
1.LF.55	Flare Jerk (Inspection, High Level)	LS55	Stop Jerk Inspection
2.LF.55	Flare Jerk (Emergency)	LS45	Stop Jerk Emergency
LF.56	Stop Jerk	LS43 LS44 LS45	Deceleration Emergency Deceleration Jerk Emergency Stop Jerk Emergency (Final Jerk, All Speeds)
LF.57	Speed Following Error	LX13	Speed Following Error
LF.58	Speed Difference	LX14	Speed Difference
LF.59	Following Error Time	-	
LF.61	Emergency Power Mode	LI04, 05, 11	Input Function 1, 2, 8
LF.62	ETS Speed	LX17	EDS Speed
LF.67	Pre-torque Gain	-	
LF.68	Pre-torque Offset	LC34	Digital Pre-Torque
LF.69	Pre-torque Direction	LC34	Digital Pre-Torque
LF.70	Speed Start Delay	LT03	Speed Start Delay
LF.71	Brake Release Delay	LT01	Brake Release Delay
LF.76	Encoder Multiplier	LE05	Encoder Multiplier Factor
LF.77	Absolute Encoder Position	LE06	Encoder Pole Position
LF.78	Current Hold Time / Brake Engage Time	LT12	Current Hold Time
LF.79	Current Ramp Down Time	LT13	Current Ramp Down Time
LF.80	Keypad Operator Software Version	Diag. #9	Operator Software Version
LF.81	Keypad Operator Software Date	Diag. #9	Operator Software Date
LF.82	X2A Input State	Diag. #4	Input Status
LF.83	X2A Output State	Diag. #4	Output Status
LF.86	Operation Phase / Set	Diag. #4	Parameter Set
LF.87	Inverter Load	Diag. #8	Drive Load
LF.88	Motor Command Speed	Home, Diag. #2, 5	Command Speed
LF.89	Actual Motor Speed (Encoder)	Home, Diag. #2, 3	Motor Speed
LF.90	Actual Elevator Speed	Home, Diag. #2, 10	Elevator Speed
LF.93	Phase Current	Home, Diag. #1, 7	Motor Current
LF.94	Peak Phase Current	Diag. #1	Peak Current
LF.95	Actual DC Voltage	Diag. #1	DC Bus Voltage
LF.96	Peak DC Voltage	Diag. #1	Peak DC Volts

Crossover Reference

v1.72 Parameter	Description	v3.21 Parameter	v3.21 Description
LF.97	Actual Output Frequency	Diag. #3	Output Frequency
LF.98	Last Fault	Diag. Log	
LF.99	Inverter State	Diag #1-6,10	Inverter Status
Ld.18	Field Weakening Corner	LM25	Field Weakening Corner
Ld.19	Field Weakening Curve	LM26	Field Weakening Speed
Ld.20	Stator Resistance	LM21	Motor Rs
Ld.21	Sigma Inductance	LM20	Motor Ls
Ld.22	Rotor Resistance	LM22	Motor Rr
Ld.23 (IM)	Magnetizing Inductance	LM23	Motor Lm
Ld.23 (PM)	Maximum Inductance	LM26	Maximum Ls
Ld.24	Motor Control	LM30	Motor Control
Ld.25	Vmax Regulation	LM31	Vmax Regulation
Ld.26	Rotor Position Mode	LM27	Motor Inductance Mode
Ld.27	KP Current	LM32	Kp Current
Ld.28	KI Current	LM33	Ki Current
Ld.29	Acceleration Torque	LC40	Acceleration Torque
Ld.30	System Inertia	LC41	System Inertia
Ld.31	FFTC Filter	LC42	FFTC Filter
Ld.32	FFTC Gain	LC43	FFTC Gain
Ld.33	Torque Command Filter	LC44	Torque Command Filter
US.1	Password	'Pass' hotkey option from Prog. Menu	
US.3	Default All LF Parameters	CH01 US05	Default Parameters Load Configuration
US.4	Load Configuration	US05	Load Configuration
US.10	Select Configuration	US03	Motor Type
US.16	E.OL2 Function	-	
US.17	Pre-torque Timer Ramp Up	LT02	Control Hold Off
US.18	Pre-torque Timer Ramp Down	-	
US.20	Max. Speed for Max. KI	LC13 LC15	Speed for Max KI Accel Speed for Max KI Decel
US.21	Speed for Min. KI	LC14 LC16	Speed for Min KI Accel Speed for Min KI Decel
US.22	Speed Dependent KP Gain	-	
US.23	Min. KP Gain at High Speed	LC25	KP High Speed
US.24	KD Speed Gain	-	
US.25	Phase Current Check	LX08	Phase Current Check
US.28	Analog Input Noise Clamp	LA04	AnIn 1 Dead Band
US.29	HSP5 Watchdog Time	LX09	SerCom. Watchdog Time
US.33	EdOH Function	LX10	EdOH Function
US.34	Analog Pattern Gain	LA05	AnIn 1 Gain

v1.72 Parameter	Description	v3.21 Parameter	v3.21 Description
US.35	Reference Splitting	LX11	Reference Splitting
US.36	External Serial Comm. Baud Rate	Fb11/LX12	Baud Rate
US.37	Test Function	LX06	Function Test
US.83	Encoder 2 Output PPR	LE35	Encoder Output PPR
US.84	Analog Out 2 Signed	LA36	AnOut2 Function
Separator			
di.00	Input Type	LI01	Type of Input
di.03	Noise Filter	LI02	Digital Input Filter
Separator			
do.42	Output Inversion	LO01	Output Inversion
do.80	Output X2A.18	LO05	Output Function O1
do.81	Output X2A.19	LO10	Output Function O2
do.82	Output X2A.24/26	LO15	Output Function RLY1
do.83	Output X2A.27/29	LO20	Output Function RLY2
LP.1	One Floor Positioning	LP01	Position Control
LP.2	Minimum Slowdown Distance	LP02	Minimum Slowdown Distance
LP.3	Slowdown Distance	LP03 LP04	High Speed Slowdown Short Floor Slowdown Distance
LP.4	Correction Distance	LP05	Correction Distance
LP.12	Current Position	Diagnostic Screen #10	Elevator Position
LP.21	Scaling Increments High	LP06	Scaling Increments High
LP.22	Scaling Increments Low	LP07	Scaling Increments Low
LP.23	Scaling Distance	LP08	Scaling Distance
Separator			
ru.00	Inverter State	DG02	Inverter State
ru.02	Ramp Output Speed	DG03	Command Speed
ru.03	Actual Frequency Display	DG17	Output Frequency
ru.09	Encoder 1 Speed	DG07	Motor Speed
ru.11	Set Torque Display	DG16	Command Torque
ru.12	Actual Torque Display	DG05	Actual Torque
ru.13	Actual Utilization	DG46	Drive Load
ru.14	Peak Utilization	DG47	Peak Load
ru.15	Apparent Current	DG06	Motor Current
ru.16	Peak Apparent Current	DG31	Peak Current
ru.18	Actual DC Voltage	DG08	DC Volts
ru.19	Peak DC Voltage	DG30	Peak DC Volts
ru.20	Output Voltage	DG18	Output Voltage
ru.21	Input Terminal State	DG01	Input Status
ru.26	Active Parameter Set	DG19	Parameter Set
ru.27	AN1 Pre-Amplifier Display	DG20	Raw Pattern
ru.28	AN1 Post Amplifier Display	DG21	Processed Pattern
ru.29	AN2 Pre-Amplifier Display	DG33	Raw Pretorque

Crossover Reference

v1.72 Parameter	Description	v3.21 Parameter	v3.21 Description
ru.30	AN2 Post Amplifier Display	DG34	Processed Pretorque
ru.34	ANOUT1 Post Amplified Display	DG35	Analog Output 1
ru.36	ANOUT2 Post Amplified Display	DG36	Analog Output 2
ru.38	Power Module Temperature	DG37	Heatsink Temp
ru.39	OL Counter Display	DG40	Overload Counter
ru.40	Power On Counter	DG43	Power On Counter
ru.41	Modulation On Counter	DG44	Run Time Counter
ru.42	Modulation Grade	DG10	Modulation Grade
ru.45	Actual Switching Frequency	DG39	Carrier Frequency
ru.46	Motor Temperature	DG38	Motor Temp
ru.54	Actual Position	DG04	Elevator Position
ru.81	Active Power	DG41	Motor Power
ru.85	Peak Encoder 1 Speed	DG32	Peak Speed
ru.87	Magnetising Current	DG09	Magnetizing Current
ru.91	Energy Over GTR7	DG42	Braking Energy
ru.92	Input Power	DG40	Electric Power

9. Errata

(v3.21) Rev1A Corrections

Section 6.2: ETS deceleration rates changed from One Floor profile rates to LS48-49 NTS/ETS rates.

Section 6.2: NTSD deceleration rates changed from NTS/ETS rates to LS33-35 One Floor profile rates..

(v3.11) Rev1B Corrections

Section 3.3.2: EnDat encoder pinout corrected, A+ and B+ swapped.

Section 4.3: SD card maximum changed from 32 to 8GB

Section 5.12.2: Timing Diagram updated; LT02 and LT12 timers.

Section 6.1: Control sequence updated.

Section 6.1: NTS input function renamed ETS and ETS function renamed NTS.

Section 6.1: NTS/ETS functions updated to accept speed command less than leveling speed (external speed control).

Section 6.2: LI03 = B(Level - Inspection - Correction), NUM = 3, changed to Decode with LI16.

Section 6.2: Main Contactor Check output function signaling and connection correct; output turns on at Direction + **Speed**, not Direction + Enable and enable should be connected to **NC** contact, not NO.

Section 6.2: Main Contactor Control input function wiring corrected; input should come from **NC** contact, not **NO** contact.

Section 6.2: Main Contactor Output + Input wiring diagram updated.

Section 6.4: LE35 selections changed.

Section 6.6: ETS profile rates changed to LS33-35 One Floor from LS48-49 ESD rates; NTS profile rates changed to LS48-49 NTS/ETS rates from LS33-35 One Floor.

Section 6.9: Timing Diagram updated; LT02 and LT12 timers.

Section 6.11: LX17, 19, 20 description changed from ETS to NTS.

Section 6.14: Timing Diagram updated; LT02 and LT12 timers.

Section 6.14: Main Contactor Control signaling description corrected; output turns on at Direction + **Speed**, not Direction + Enable.

Section 6.14: Cabinet Fan On heatsink temperature output condition changed from 45 to 40 degrees Celsius.

10. Combivis

Combivis is a computer program that can be used to connect with the drive. The program can be used to set parameters in the drive, upload parameter settings from the drive, download parameters to the drive, and take scope traces of parameters for evaluation and diagnostics.

10.1 Software

The KEB Combivis 5.6 or Combivis 6 software is available for download free of charge from the website www.kebamerica.com under the Service & Downloads > Downloads by searching for File Type = Software and Topic = Frequency Inverter. The Combivis 5.6 program will be labeled CV56 (.exe)

Supported operating systems:

- Windows 95
- Windows 98
- Windows XP (SP1, 2, 3)
- Windows NT
- Windows Vista
- Windows 7 Enterprise
- Windows 7, 32- and 64-bit



The Combivis 5.6 software download is a full version and does not need to be registered.

10.1.1 Configuration IDs

Configuration IDs are templates which provide the corresponding parameter structure and text for the drive data to be viewed with Combivis. The drive and keypad operator both have configuration IDs for different modes of operation. Without the proper configuration ID, Combivis may not be able to connect with the drive or display the correct parameter information. In addition, the configuration IDs may not necessarily be uploaded from the drive or keypad operator when connecting to Combivis; in particular, the keypad operator configuration IDs.

A full set of configuration IDs are available upon request from KEB. The files can then be saved to the directory **C:\Program Files\KEB\CFGS** for Combivis 5.6 and the directory **C:\Program Files\KEB\Combivis_6\KEB\ParameterDescription** for Combivis 6.

10.2 Cables

The following cables can be used to connect with Combivis to X6D serial port.

Combivis Cable: 0058025-001D

USB-Serial Adapter: 0000000-7938



Not all USB to serial adapters will work with Combivis; an FTDI chipset is required. If the chipset is unknown or the driver is not installed, it cannot be guaranteed the device will connect. The adapter supplied by KEB has the correct chipset.

Notes:

KEB AMERICA INC.
5100 Valley Industrial Blvd.
Shakopee, MN 55379
Phone: 952-224-1400
www.kebamerica.com

© KEB	
Mat. No.	00F5LUB-K321
Rev.	1A
Date	08/2014